

management together, where it collects a large number of log files which is hence reanalyzed, framed, and regrouped to a single operation report or represented as real-time information security situation on display panel, so that managers can learn and obtain sufficient information which can be quickly understood to determine the level of risk and even to prevent in advance for future risk. The advantages of information security protection system are that traditional method of manual processing and passive safety protection mode is changed by intellectualization method to the framework of automatic management control mechanism, predictive statistical analysis tool, standardized management regulations and process, in order to achieve the objectives of reducing damages, avoiding risks, and improving operation. Besides, information security protection system not only deal with information security issues from the technical level, but also in order to strengthen the safety management, it integrates different technologies and business operations to directly avoid the information security incidents from the original source rather than initiative warning beforehand, which integrates information security, risk control and intelligence to reduce the management staffs and time invested cost, and actively predict and find out the problems and weaknesses for correction, and ensure companies and users have security network environment and real-time dynamic response mechanism to reduce damage and implement national information security policy.

4.8 Intelligent science Park's disaster prevention and control information system

The intelligent disaster prevention and control information system can enhance park's disaster prevention level, by combining natural disaster prevention units such as water conservancy and geology with information platforms such as 3G, mobile Internet, Internet of things technology which provides systems for intelligent dispatch, cooperative control, comprehensive release, unite protection function as a disaster reaction, prevention and rescue work. Based on the intelligent information, the works such as disaster management, disaster response, emergency dispatch, and evaluation feedback, etc., can improve performance in terms of actively preventing and reducing disaster to establish a data sharing mechanism of disaster monitoring, strengthen professional united disaster prevention mechanism, establish a comprehensive and reliable flow of warning system, and establish disaster prevention technology innovation mechanism. In order to solve the caused difficulties by disaster prevention decision, it must control correct and sufficient investigations, real-time monitoring, observation data, information storage, and disaster information, which will be transformed as important reference information for managers to provide a

variety of warning and decision supporting information with automatic learning and innovation ability of linking various information through system research and analysis and integration. And the system shall assist the relevant business decision makers in responding in advance and coordinating and communicating among departments. Furthermore, if it can integrate a lot of space geographic information owned by the government and cloud service of real-time sensing data, and add academic modeling knowledge, which will be helpful to make better and more correct decision policy through past, present and future of space geographic information.

4.9 The Intelligent Science Park's Application Service Platform

Application service is external presentation of intelligence, and is also an important project of intelligent park construction. From analysis and calculation of digital information, it will build up the association with implicit messages of all kinds of sensory data, which is thus used to integrate main application services both inside and outside the park for park's intelligent decision-making. In general, the application services include public administration service, park management service, company IT service, industrial production, business services, and public services, etc., which can be divided into three types: intelligent administration, intelligent industry, and intelligent society.

a. Intelligent administration: it mainly contains electronic administrative service platform, public information release platform, security park platform, emergency dispatching platform, virtual management center, park integrated management platform, and park traffic management platform, etc.

b. Intelligent industry: it includes smart business platform (Internet payment, SMS payment, and RFID payment), smart logistics and distribution, logistics information platform, and company public service platform (personnel training, personnel agency, personnel sharing), etc.

c. Intelligent society: it comprises intelligent medical service platform (medical information sharing platform, small and medium-sized hospital informationization, electronic payment, and remote medical treatment), intelligent education platform (education resources information sharing, and digital campus), intelligent community service platform (intelligent park, and smart home).

5. CONCLUSION

Since IBM proposed the concept of "the wisdom of the Earth" in 2008, the world has begun to pay attention to the construction of intelligent city. As one

of important parts of the city, the science park has brought economic contribution from past development. With facing the transformation of economic growth mode and new situation of industrial structure upgrade, the development of the science park has a new direction which is tending to focus on ecological, green, and energy saving under the spirit of sustainable development. While intelligent science and technology can assist and use information and communication and digital method to control management which is interpretation of seemingly contradictory nature and science and technology. Also, from technology innovation, it transforms the manufacturing into creation to make the value added industrial chain with more potential for the future. Moreover, park management is towards to urbanization to make more complex social function through intellectualization to establish a park with complete living functions rather than production oriented environmental structure.

The construction of the park is a long period and systematic important project which has characteristics including that the content of construction is complex, long construction period, many kinds of technology, and large amount of investment capital. Therefore, the construction process of intelligent science park requires unified planning and management and supervision by specific organizations, and given the persistent guidance. In the early construction stage, overall top to bottom planning design shall be performed to determine the implementation of every regulation and standard, in order to ensure the completion of construction and expandable development with planning. And thus, the main key working procedures are summarized as follows:

1. In-depth analysis of the requirements of park intelligent functions; Formulate the overall planning principle of intelligent construction;
2. Formulate standardized regulations for the use of the buildings in every area and construction standards;
3. Make sure the establishment and segment principle for subsystem of intelligent construction;
4. Formulate standards for technical information and functions of each subsystem and make sure the actual compliance;
5. Plan key projects of intelligent subsystem, and estimate construction budget;
6. Schedule development plan by stage and area and make construction principle to provide the preliminary design of regulatory plan.

The intelligent science park can realize the ideal of breaking the traditional closed science park's information island phenomenon and establishing multi system information sharing system. And also, on the basis of unified network, unified infrastructure, and unified digital environment, it provides an integrated intelligent platform system to establish a highly execution efficiency operation management center. This operation

management center connects all kinds of specific fields in the park (energy, water supply and drainage, buildings, security, and traffic, etc.) and horizontal connects them in series based on the standards to propose monitoring and control management with warning where the prevention and safety protection of future events is established through data collection to strictly comply with various regulations and standard process to in transaction processing, special reports, presentation, information storage. And with continuous digital information storage accumulation and autonomous learning, it setups an artificial intelligence with active growth to construct the intelligent of science park with truly user-friendly, high-growth and high efficient management under the way of constantly revised, correction and evolution.

REFERENCES

- Benezeth, Y., Laurent, H., et al., (2011) . “Towards a sensor for detecting human presence and characterizing activity.” *Energy Buildings*, 43, 305–314.
- Calavia ,L., Baladrón , C.,(2012) . “A Semantic Autonomous Video Surveillance System for Dense Camera Networks in Smart Cities.” *Sensors*, 12 (8) , 10407-10429.
- Deakin, M., (2010) . *SCRAN: the SmartCities (inter) regional academic network supporting the development of a trans-national comparator for the standardisation of e-government services*. Springer , Berlin
- Decker, A., (2014) . “Smart Law for Smart Cities Symposium.” *Fordham Urban Law Journal*. 41(5), 1491-1498.
- Giffinger, R., Fertner, C., et al., (2007) . *Smart Cities: Ranking of European Medium-Sized Cities*; Centre of Regional Science: Vienna, Austria.
- Ko, H., Bae, K., et al. (2014) . “A Study on the Security Algorithm for Contexts in Smart Cities.” *International Journal of Distributed Sensor Networks*. 1-8.
- Mitton, N., Papavassiliou, S., et al., (2012) . “Combining Cloud and sensors in a smart city environment.” *EURASIP J. Wirel. Commun. Netw.*, 247, 1–20.
- Ni, L., Zhang, D., et al., (2011) . “RFID-based localization and tracking technologies.” *IEEE Wirel. Commun*, 18, 45–51.
- Oprea, A., Courbat, J., et al., (2009) . “Multi sensor platform on plastic foil for environmental monitoring.” *Procedia Chem.*, 1, 597–600.
- Roche, S. (2014) . “Geographic Information Science I: Why does a smart city need to be spatially enabled?” *Progress in Human Geography*, 38(5) ,703–711.
- Roche, S. (2014) . “Geographic Information Science I: Why does a smart city need to be spatially enabled?” *Progress in Human Geography*, 38(5) ,703–711.
- Vo, C., Chilamkurti, N. , et al., (2011) . “An RFID based business process framework for asset management.” *J. Netw. Comput. Appl.*, 34, 990–997.



NO.84

Local Identity Assessment in Heritage Tourism Development

CASE STUDY: PESAREAN AER MATA AROSBAYA BANGKALAN MADURA

Katherine Elvira Dwi Putri Permanasari^{1*}, Endang Titi Sunarti Darjosanjoto¹
and Murni Rachmawati¹

1 Department of Architecture, Institut Teknologi Sepuluh Nopember

**Corresponding Author, Email: keyvira@yahoo.com*

Key words: Bangkalan, heritage, local identity, pesarean, tourism development

Abstract: Challenges in the development of the heritage area nowadays is to preserve its cultural characters through local identity. This paper aims to explore the local identity that pertain to the development of Pesarean Aer Mata Arosbaya Bangkalan as heritage tourism object. The complexity of pesarean can be describes as an ancient cemetery for the descendants of Kraton Bangkalan. redevelopment is needed to accommodate the needs of tourism development that still maintain the local character of the area. The result of this study is the analysis of local identity characters that needs to be applied to the future development.



NO.102

Domestic Investment-Induced Urbanization in Inland China in the Era of Globalization:

Case Study of the Changzhutan (CZT) Region

Lizhu Dai¹ and Guicai Li^{1*}

1 Peking University Shenzhen Graduate School

**Corresponding Author, Email: daisy840228@hotmail.com ; ligc@pkusz.edu.cn*

Key words: Urbanization; extended metropolitan regions; changzhutan; China

Abstract: The Global Economic Crises of 1997 have forced the Chinese government to take domestic demand as an important national development strategy. New EMRs in inland China, e.g., the CZT EMR in Hunan province, the Wuhan EMR in Hubei province, and the Zhongyuan EMR in Henan province, are designated by the central government to promote domestic demand. Would these EMRs in inland China share the same characteristics and mechanisms as those in the coastal areas? An examination of the new characteristics and mechanisms for EMR formation is thus a meaningful exercise. Using the case of the CZT EMR, the paper analyzes transformational characteristics of population growth, economic development, investment, transportation in Central China which suggested a strong direction of the governments from the central to local levels. Through the method of Fixed-effects model, it proposes a new stage of EMRs in China, i.e. EMR II, which would likely be embedded in local forces against the nation's new development strategy of emphasizing domestic demand in the context of the country's transition toward a major global economy.

1 INTRODUCTION

Over the last two decades, China has taken a growing part of the international trade and industrial production. Economic development changes the level, pattern and extension of urbanization in China with FDI and export playing a crucial role, notably along coastal areas where accessibility to global market is optimal (Sit and Yang (1997)). Since the Asian Economic Crisis of 1997, the Chinese government has increasingly realized that the past strategy for achieving economic growth mainly through exports and foreign investments would be neither safe nor sustainable in the post 2000 new global environment (Chen (2010)). According to China's 11th

and 12th Five-year Plans, developing domestic demand is emphasized as the crucial, new national development strategy. Central China has therefore stood out to be the new strategic focus for future growth due to its locational advantage close to China's western and eastern regions (Wang, Bai et al. (2009); Xiao and Gu (2009)). Indeed, the growth there has been remarkable since 2000. The GDP of provinces in the central region have grown with a rate higher than 10% with the formation of a number of extended metropolitan regions. Noteworthy among these are the CZT EMR in Hunan province, the Zhongyuan EMR in Henan province, and the Wuhan EMR in Hubei province. In 2006, they were designated by the central government as the focal points to drive the economic development of surrounding cities, so as to realize sustainable development of the central region. This is to be achieved through improving industrial structure, transforming production mode, protecting ecological environment, and promoting society harmony (GOSC (2006)). The strategy adopted was to become the production bases for grain, energy, modern equipment and high-tech industry. They too will serve as integrated transportation junctions for Central China.

These new growth regions are the receiving centers for the industrial shift from the coastal area of China. For example, in 2010, Hunan province has attracted 2795 industrial projects, of which around 2264 are from other regions of China (DCHP, 2011)¹⁸. Guangdong, Fujian, Hong Kong, and Shanghai are the major origins of these transferred industrial moves. Such inter-regional economic interaction between Central and Coastal China is facilitated by the high-speed train and highway construction that has paved a pattern of transport trunk route that include four horizontal lines and four vertical lines to link East China with the Southwest, Northwest and Central China (Figure 1). Moreover, the CZT EMR and the Wuhan EMR have been designated as China's first Reform Experimental Zones for the "two-oriented" society (resource conserving and environmental-friendly)¹⁹, as the countries' response to the global call for a "low-carbon economy" (Wuhan Government web, 2008).²⁰ To help to realize these objectives, these interior EMRs are provided substantial policy incentives on investment, tariff, land, resource and ecological compensation. Thus these EMRs represent China's new pattern of regional urban growth in the 21st century.

¹⁸ DCHP (Department of Commerce of Hunan Province), 'A report on Hunan's Commerce', 2011, accessed on January 7, 2011, <http://www.hunancom.gov.cn/swtj/209981.htm>.

¹⁹ "两型社会".

²⁰ Wuhan Government web (2008). <http://wh2xsh.wh.gov.cn/gjwj/2008/08/04110953.html>

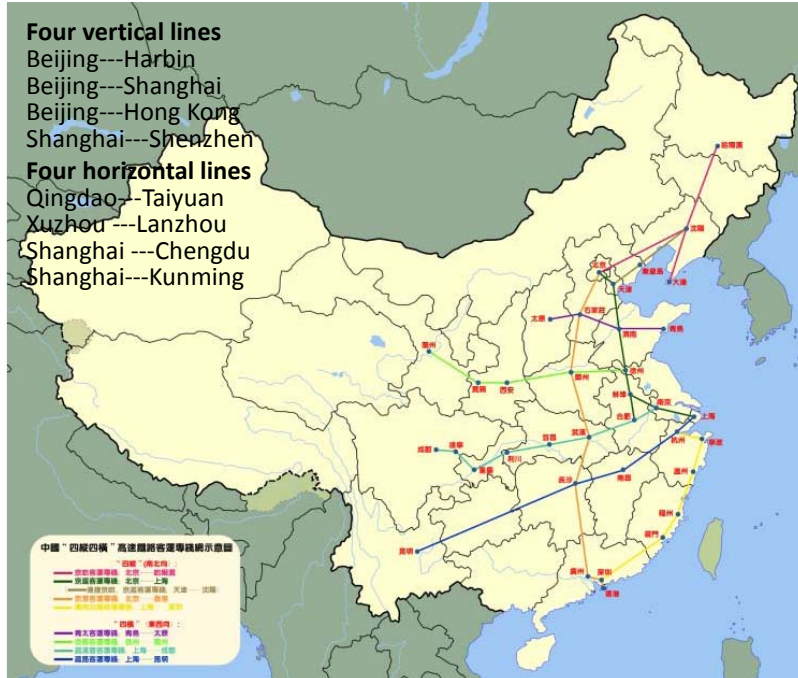

Figure 1. China's Medium-Long Term Plan for high-speed Railway Construction in 2008

Under these circumstances, traditional mechanism for coastal EMRs, e.g., the Pearl River Delta (PRD) and the Yangtze River Delta (YRD), may not apply to the interior region, as new rounds of development policies in China, such as environment conservation measures and industrial shifts, provide impetus for new urbanization there. As a result, it is impetus for us to ask questions: could the theory of traditional EMRs in Coastal China apply to those in interior region and, if not, to what extent have the interior region been distinct with the coastal area. To answer these questions, we also need to answer: what are the characteristics of this region and what has driven its growth?

The CZT EMR offers a fresh and timely opportunity for examining the changing relationship between globalization, domestic demand, and urbanization in China. Using it as a case study, this paper will first give a general description of this area, followed by an analysis of the recent, especially 1990-2010 economic and social transformational characteristics of this region in terms of population, economic development, investment, and transportation. The mechanism of economic growth will be explored based on a fixed-effects model of industrial output per area with various economic and social factors described earlier. It argues that a new subset of urbanization is under way, i.e., a new region-based urbanization driven by the combined forces of domestic demand and globalization.

2 THEORETICAL FRAMEWORK FOR THE EMR

Since the 1980s, the Asian countries have witnessed the penetration of global forces and a burst of large urban region. Hence, increased attention has been paid to a region-based urbanization in developing countries that shows significant differences from a city-based and continuous system of urban and suburban areas in developed countries (McGee (1989); McGee and Greenberg (1992); Sit (2005); McGee, Lin et al. (2007); Zheng (2009)). It is noted by the development of large areas of ‘desakota’ (semi-rural, semi-urban or rural–urban transitional zones) around the major urban centers.

Globalization, incubating the First Global Shift, i.e., the shift of labor-intensive and low-value added segments of production from the Developed Countries to selected newly industrializing economies, since the 1980s has been recognized as one of the major driving forces for the development of these EMRs (Dicken (2007)). As important international port cities, with the largest concentration of population, skilled labor, modern communication and transportation infrastructure, and a better-developed economy than the rest of their respective countries, they possessed obvious advantages for foreign direct investment (FDI) and export-oriented economic growth. Cities such as Bangkok, Jakarta and Seoul have significantly increased their participation in the global economy (Forbes (1997)). The Jakarta EMR attracted more than 36% of the FDI projects in Indonesia, with only 0.3% of national territory and 10.6% of her total population (Soegijoko and Kusbiantoro (2001)). In China, the Beijing EMR, Shanghai EMR, and Hong Kong EMR, together attracted 73% of China’s FDI inflow and accounted for 73.1% of her total exports in 1999, with only 1.2% of the nation’s territory occupied and 7.5% of her total population accommodation(Sit (2005)). The resultant increase in export-oriented manufacturing and logistics has fuelled economic and urban growth leading to the functional-linked region.

It is believed that the emergence of EMRs is a response of economic globalization. In response to the grave economic crisis, government policies shifted from entrenched Keynesian theories in 1950-1970 that the main goal is to achieve a more balanced spatial distribution of productive activities, employment and population, to “structural adjustment policies” which prefer to penetrating global market forces in the existing urban centers and strengthening the interaction of rural and urban, e.g. the “opening policies” in China of 1978 and “New Economic Policy” of 1991 (De Mattos (1994)). These reforms led to enormous influx of FDI, to intensive industrialization processes through international relocation of production locations, and to considerable expansion of the services sector with increasing demand for office space in the core region, as well as to a massive migration into the EMRs. Many other factors were also identified to contribute to this process,

i.e., large-scale housing and new town, industrial estate, and toll road development (Firman and Dharmapatni (1995)).

In China, many scholars have followed McGee's work, and provided a pool of cases accounting that globalization is one of the most important factors of rural industrialization and resultant EMRs formation (Xu and Zhou (1994); Yan, Guo, et al. (1997); Yao (1992); Lin (2001)). Xu (1994) reckoned that industrialization is the basic dynamic for the PRD's urbanization, while FDI is one of the most influential factors for this industrialization. Resulted from higher concentration of people and production in the city, the production cost soar which pushes manufacturing production outward. The city economic activities sprawl into the rural places promoting the integration and urbanization. However, Lin (2001) argued rapid expansion of the extended metropolitan zone has been driven primarily by forces of rural industrialization at the grassroots level rather than just a result of urban sprawl. Global capitalism had to compromise with socialist soil, as "The intrusion of global forces has not homogenized local particularities" (Lin, 2001, pp.383). This is also identified as "bottom-top" urbanization, rural urbanization or spontaneous urbanization in other studies (Shen (2006)). Sit and Yang (1997)'s proposed that this is a new subset of urbanization, i.e. foreign-investment-induced urbanization, or exo-urbanization, largely driven by 'labor-intensive and assembly manufacturing' type of export-oriented industrialization based on inputs of large quantities of low-cost, low-skilled labor, and cheap land. Zheng (2009) further defined it as a dispersed regional concentration with the involvement of the 'remote rural areas' into in situ industrialization as a response to globalization.

Apart from FDI and export, many scholars also stressed the contribution of transportation, infrastructure, migration, marketization, and policies on this industrialization and hence the formation of EMRs (Shen (1999); Chen (2009); Liu, Yang et al. (2006); Ou, Zhen et al. (2008); Ning (2011)). Chen (2009) claimed that Chinese urbanization interacts with the development of transport network and the two serve as cause and effect to each other. Similarly, the construction of infrastructure improves the urban region's competitiveness. Shen (1999) analyzed the characteristics of migration of migrants from rural to urban suggesting their role in producing cheap labor forces in EMRs in coastal areas. Lin (2002) asserted that market reforms and relaxation of state control over local development since the late 1970s have allowed the rural industrialization in a large number of small cities especially in the coastal EMRs. Ou, Zhen et al. (2008) both proved that marketization is the most important forces to the urbanization in coastal areas which might even surpass the influence of globalization. Ning (2011) elaborated macro policies play vital roles in the construction of inter-city transportation, as well as in industrial development, migration, foreign investment, deregulation, and marketization.

Since the 21 century, the dramatic development of inland urban-regions,

like the Changzhutan EMR in Hunan province, Wuhan EMR in Hubei province and Chengyu EMR in Sichuan and Chongqing, has attracted more and more domestic scholars' attention (Zhou, Tang et al. (2002); Shen (2007); Li (2008)). However, these studies in Central China have not yet probed into the nature and true mechanism. Especially nearly all studies published in English were focused on the coastal area, little has been known in Central China in English-spoken academic world.

3 THE CZT EMR IN THE NEW NATIONAL AND GLOBAL SETTINGS

As a mega-urban region emerged in the post-2000 era, the CZT EMR provides a distinct and fresh example for analyzing the industrialisation and urbanization in Interior China (Dai, Sit et al. (2015)). Located in Central China, it is a crucial crossroad with North, Coastal and South China (Figure 1). The CZT, as a part of Hunan province, has lagged behind the coastal regions of China in 1980-2000 and a major source of outmigration. It was recently officially designated by the central government as a part of China's 'the Rise of Central China' strategy and a 'Reform Experimental Zone' for the nation's new 'Two-oriented (toward resource conserving and environmental-friendly) Society' for reducing regional disparity in China and improving its economic competitiveness as well as environmental condition.²¹ As such, it has been given preferential policies and increased its economic growth speed. Viewed in a political economy perspective, the CZT has served not only as the testing site for the environmental protection measures, but more importantly as a valuable laboratory for the domestic forces, as a result of the decline in export demand due to the Global Economic Crisis of 2008. Hence, the study on the mechanisms and development characteristics of such a 'pioneer' region will provide important lessons for other recently developing regions in Inland China or even perhaps other regions in LDCs which have also been exposed to shrinking global forces.

The region's delineation has been laid down in as a political strategy in 2006, i.e., it is an urban cluster that contains Changsha, Zhuzhou and Xiangtan as core cities surrounded by Yueyang, Changde, Yiyang, Loudi and Hengyang as peripheral areas. It is called "three + five" for short.²² The region has an area of 99,600 square km, comprising 8 prefecture-level cities, 12 county-level cities, 28 counties, and 24 municipal districts. In 2010, it generated a local GDP of RMB 1.26 trillion, with a population of 40.73 million. It is connected to the southeast coastal areas and thus benefits from a

²¹ “中部崛起” which means to bolster the central part of China.

²² “3+5”城市群.

big inland market. It is also a social, economic, cultural, educational and technological hub of Hunan Province (Figure 2).

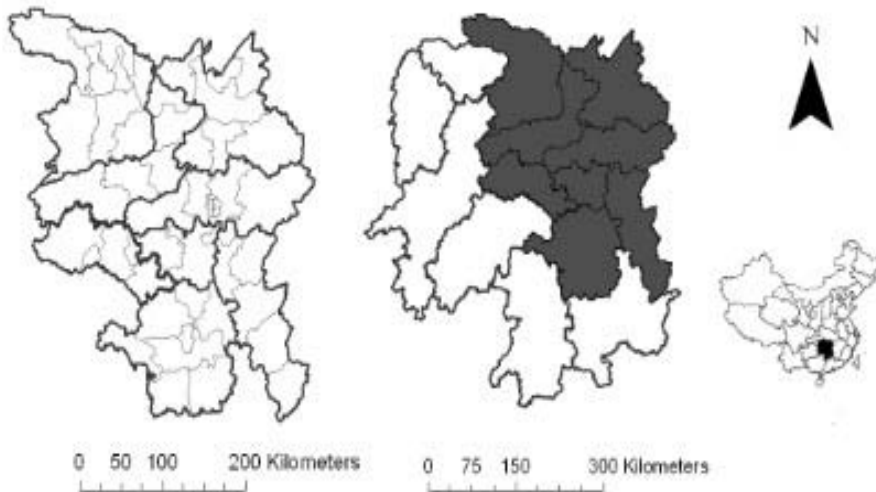

Figure 2. Map of the CZT EMR in Hunan Province

The CZT is a major player in economic development in Hunan Province. With the province's 57% of the population and 47% of the land area, the cluster generated 78% of its GDP, 90% of its industrial added value, 72% of its services and 84% of its export of the province in 2010 (Table 1). Meanwhile, it concentrated 84% of its investment in fixed assets (IFA) and 78% of its actual utilized foreign direct investment (AUFDI). Its economic structure, measured by the primary, secondary and tertiary sectors is 11:52:37. As one of the heavily industrialized regions in China, the integrated industrial system in the CZT EMR is based on machinery, electronics, melting, textile, food, chemical, medicine, and publishing.

Table 1. Economic indicators in the CZT and their shares in Hunan in 2010

Item	Population (10000)	Land area (km ²)	GDP (RMB 100 million)		Tertiary Industry (%)	IFA (RMB 100 million)	AUFDI (USD 10000)	Export (USD 10000)
			100	Secondar y Industry				
Total		9654			4622.9	8266.0	40783	66795
amount	4008.16	0	12558	6491.75	5	5	0	5
Share in Hunan provinc e (%)	56.5	46	78.3	88.4	72.6	84.2	78.7	84

Source: Hunan Statistical Yearbook 2011

4 SOCIAL-ECONOMIC TRANSFORMATION OF THE CZT

The transformation of this region in terms of urbanization level, economic development, investment, transportation is remarkable.

4.1 Population change

The urbanization level in the region since has been doubled from 22% to 48%. From 1990 to 2010, the population in this region registered little growth from 360 thousands to 400 thousands, while the population living in urban areas has grown in a much faster speed from 80 thousands to 190 thousands (Figure 3).²³ It could be seen that population living in urban areas grew slightly faster since 2000, with an annual growth speed at 5% compared to 4% in 1990-2000. Accompanied from this is the remarkable growth of built-up land from 462 to 793 square km at an annual growth speed of 6% during the latter period. The net loss of population living in rural and

²³ Due to the change of standard of urban area, the data might not be very consistent for the comparison. However, it gives a general description of population living in urban and rural areas.

semi-rural areas is due to a huge number of them migrates to coastal areas searching for job opportunities. It was estimated that there are more than 7 million population in Hunan migrated outside the province in 2010, 78% of which moved to Guangdong province.²⁴ However, since 2008 this flow has turned direction in the face of an economic slowing down in coastal areas, e.g. Guangdong, since the ‘Financial Tsunami’ and the development of the interior provinces. It is estimated that around 2.8m migrant workers in the Delta had returned to Hunan province in 2008-2009.²⁵ According to a survey of 500 migrant workers conducted by Changsha Evening News on November 6-9, 2008, around 56.7% of them were construction or production workers, and only 6% were engaged in administration.²⁶ They returned to Hunan province mostly due to decreasing job opportunities and unfair work and poor living conditions in the coastal areas, the shift of industries to Hunan, and better policy environment for farming in hometown villages. More than 60% of the respondents chose to look for jobs in the cities of the CZT. Such ‘backflow’ would get stronger when more labour-intensive industries move their location to the CZT from the coastal areas. Compared with the 6.7m workers registered in the urban area in 2010, the ‘backflow’ has been an important new labour factor. Moreover, this region is still not a very attracting place for immigration. The floating population from outside the province has been only about 1% of the permanent resident population during this whole period. Moreover,

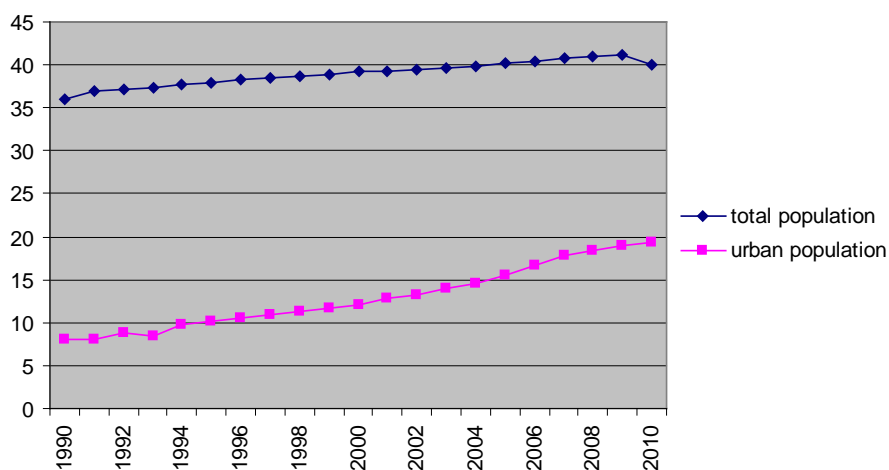

²⁴ Hunan Rural Labor Force Exceed 10 Million. China Daily, January 21, 2011, accessed on December 21, 2011, http://www.chinadaily.com.cn/dfpd/hun/2011-01/21/content_11894088.htm.

²⁵<http://www.zgnyqss.com/news/sannong/2010/0312/18016.html> (Accessed on February 7, 2012)

²⁶<http://www.zgnyqss.com/news/sannong/2010/0312/18016.html> (Accessed on February 7, 2012)

Figure 3. Change of population in the CZT, 1990-2010 (Unit: 1 million persons)

4.2 Economic development

The transformation of this region in terms of GDP and GDP per capita is more remarkable (Figure 4). The local GDP has grown from RMB 48.5 billion in 1990 to RMB 1256 billion in 2010, with an increasing growth rate of up to 15% in 2010. Since 1990, its local GDP per capita has been higher than that of the province. In 2010 it surpassed the national level at the amount of RMB 31843. In the GDP composition, the share of the primary sector has dropped dramatically from 32% in 1992 to 11% in 2010, while the share of the secondary and tertiary sectors has shown a tendency to increase around 10% respectively underlining dramatic structural change in 1992-2010.

Industrial output has witnessed the most dramatic growth from 56 billion in 1990 to 1515 billion in 2010 at an annual growth speed of 11.5% (Figure 4). Especially since 2000, the annual growth speed has been up to 22.8%. Increasing industrial output is generated from development districts. In 2010, around 50% of the CZT's industrial output was produced from these districts. Until 2010, 50 development districts were established to guide the development of industries toward energy saving and environmental friendly. Within the development districts are standardized prebuilt factories, rationalized district planning, and prioritized structure of land uses. Compared to the industries dispersed in the whole region as the image of 'every household light fire to engage in industrial activities' in the coastal area in the 1990s that caused tremendous and uncontrolled pollution, it is believed that development district is a better form to control waste discharge and increase land use efficiency (Wang, Wu et al. (2006)). Aside from closing high polluted industries, e.g. in 2008-2011, around 1017 enterprises have been closed²⁷, high-tech industries are prioritized in this region to realize the expectation of saving energy and environmental friendly. Six high-tech development districts are directed specifically for wooing high-tech industries. For instance, Changsha High-tech Development District would lay emphasis on high-tech research and development, and the development of electronic information and new materials. The gross output value of high-tech products has increased from RMB 54 billion in 2001 to RMB 577 billion in 2010 accounting for around 40% of its industrial output in the CZT. These new industries are mostly biological medicine and medical instruments, new materials, high-technology to transform traditional industries through new energy resources and energy saving technologies. Except Yiyang High-tech Development District, these high-tech

²⁷ An interview with a senior official in the CZT office on March 20, 2012.

development districts are national level. The national levels enjoy the equivalent administrative and decision power of municipal government authorities. They thus have more flexible systems and higher efficiency in attracting high-tech industries in. These five high-tech industries generated 65.4 billion yuan added value of high-tech products, accounting for 47% of its added value in all the province's development district.

Export has also grown from US\$ 496 million to 6680 million at an annual growth speed of 15.5%. It also enjoyed a much faster speed after 2000 at the amount of 24.4% respectively, although with some fluctuation from 2008 to 2010 due to the Global Economic Crisis of 2008. Along with the rise of land and labor cost in coastal area of China, as well as the appreciation of RMB, the processing trade industry in the coastal regions have lost its advantage and many labor-intensive industries has gone bankruptcy or move outside. The state council proposed to guide and promote the shift of processing trade industry leading to the development of central and western regions of China. On July, 23 of 2007, the Department of Commercial, and General Administration of Customs united to announce their differentiating adjustments on the coastal and interior regions of China. The coastal area is not allowed for new processing trade industry to enter, while the interior region continues to implement bank cash deposit machine account with "idling" management, so as to attract processing industry to the interior region from the coastal region as well as foreign countries. On November 22 of the same year, the Department of Commerce and National Development Bank announced their opinions on supporting the shift of processing industry to the central and western regions of China. They included building 50 bases as afore-mentioned to attract different kinds of trade industries with the support of national policy and policy-based lending. Hence the export here enjoyed considerable growth and promote the industrial growth in the interior region. However, the export per GDP has decreased from 88 USD/10000 yuan in 1995 to 50 USD/10000 yuan in 2010 that have been both much lower than the national average (245 and 393 USD/10000 yuan respectively). One phenomenon worth to mention is the mushrooming of industrial output and export output from TVEs. Not only the industrial gross output of TVEs in the province has increased from 14 to 615 billion yuan with its share in total of the province rising from 24% to 46% from 1990 to 2009, but its export output has also remarkably grown from 0.8 to 23.6 billion yuan with its share in total of the province from 19% to 63%.

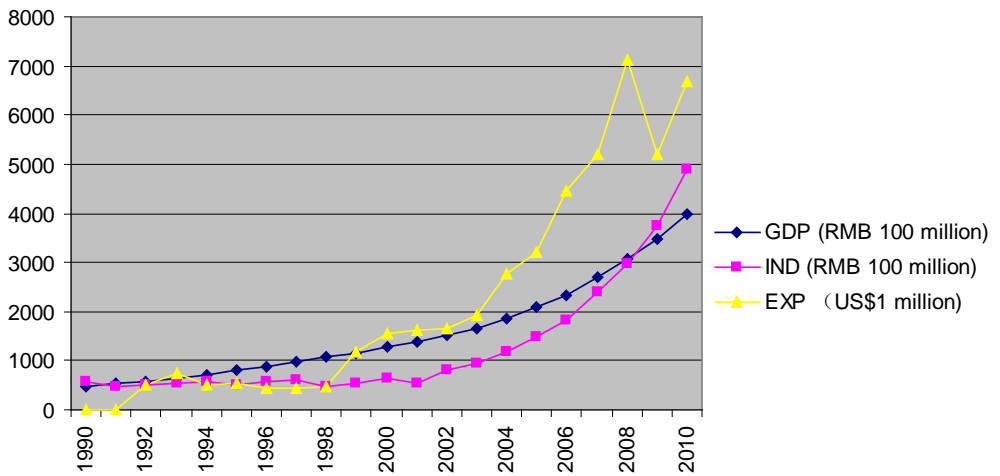

Figure 4. Change of GDP, IND and EXP in the CZT, 1990-2010

4.3 Investment

Investment in the CZT EMR in fixed assets has increased in the period of 1990-2010 dramatically from RMB 5 billion to RMB 745 billion at an annual growth speed of 21.2% (Figure 5). Concomitantly, AUFDI has also increased tremendously from 208 million to 4078 million in the period of 1991-2010. Not surprisingly, they both registered a much faster growth speed in the latter ten years. Within the investment in fixed assets, most of capital for the development and expansion of basic infrastructure is domestically derived. As shown in Table 2, less than 3% of Hunan's investment funding in fixed assets came from foreign investors in 2000-2010.

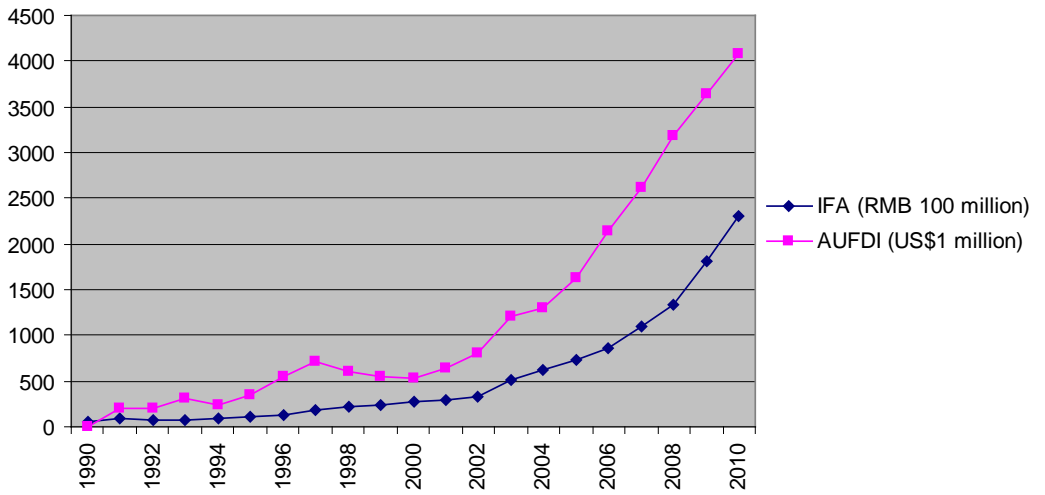

Figure 5. Change of IFA and AUFDI in the CZT, 1990-2010

Table 2. Different-source of IFA in Hunan (Unit 100 million Yuan)

	Total	State Budgetary Appropriation	Domestic Loans	Bonds	Foreign Investment	Fundraising	Others
2000	1066.27	76.49	213.41	2.34	22.01	623.37	128.65
2006	3242.38	186.83	489.28	1.89	88.14	2028.05	448.19
2007	4294.36	275.65	520.85	3.66	93.05	2739.51	661.65
2008	5649.69	549.63	626.50	11.14	88.70	3723.55	650.17
2009	7695.27	620.50	1128.61	5.49	75.96	4902.72	961.98
2010	9821.06	652.68	1227.99	20.94	75.20	6637.69	1206.57

Source: Hunan Statistical Yearbook 2001, 2007-2010

A substantial amount of this domestic investment came mainly as industrial shift from coastal areas. In 2004 H unan province signed the “Regional Cooperation Agreement on Pan Pearl River Delta” and started to increase its connection and cooperation with the PRD region. To bolster “Central Rise”, “Expo Central China” has been organized yearly by six provinces of Central China with National Commerce Department since 2006. It has provided a very efficient platform for the industrial shift from coastal areas and foreign countries. In 2008, H unan province formulated a programmatic document “Opinions on attracting industrial shift to improve processing trade in Hunan province” proposing to become the base for attracting industrial shift from coastal areas especially from the PRD and urged the cooperation of different departments to form the supportive environment. They have improved the infrastructure, including transport like the construction of high-speed railways and highways, energy network and communication systems to link their region to the more developed regions. They have also improved services through simplifying administration procedures and training their civil servants for enterprises. For example, it only took six months for the manufacturer Foxcoon Technology Group to station at Hengyang of the CZT since the company decided to shift part of their production to the interior region of China in 2010. For the whole year, the CZT has attracted 121 billion actual utilized domestic direct investments (AUDDI) from other provinces, almost 10 times of the 12 billion in 2002 (Table 3). It has accounted for approximately 20% of the total investment in fixed assets (IFA). In comparison, although AUFDI has registered dramatic growth, its share in IFA has decreased from 9% to 4% in this period.

Table 3. Comparison of AUDDI and AUFDI in the CZT

	2002	2005	2006	2007	2008	2009	2010
AUDDI (RMB 100 million)	122.11	492.70	607.98	723.36	853.77	1006.85	1209.52
AUDDI per IFA (%)	16.03	25.91	26.10	23.27	20.42	17.90	16.23
AUFDI (US\$ 100 million)	8.06	16.35	21.42	26.20	31.87	36.45	40.78
AUFDI per IFA (%)	8.76	7.05	7.26	6.41	5.22	4.41	3.64

Source: Hunan Statistical Yearbook 1991, 2001, 2011

4.4 Transportation

Transportation serves a crucial function for the flow of population and economic activities in the region. The CZT has also witnessed a gigantic growth of population traffic (PT) and cargo traffic (CT) especially since 2000 (Figure 6). Population traffic has increased from 312 to 1209 million persons with an annual growth speed at 7%. Cargo traffic has increased more dramatically than population traffic at an annual growth speed at 10%. They both showed a faster growth since 2000 especially for cargo traffic which has an annual growth speed at 15% in the latter period compared to 5% in the previous period. One thing worth to mention is that the running of Wu Guang high-speed railway since 2009 from Wuhan-Guangzhou which passes through Changsha, Zhuzhou, Hengshan, Hengyang, Moyang, Yueyang, Biluo in the CZT has dramatically increased its passenger traffic. It has dramatically shortened the time between Guangzhou and Changsha from around nine to two and a half hours. In the unfolding “Twelve’s Five national railway construction plan”, there are eight lines passing through the CZT including the inter-city rail lines in this region. The Jing Guang (Beijing-Guangzhou) and Hu Kun (Shanghai-Kunming) high-speed railways in construction will be crossed in Changsha of Hunan. For this reason, the Global Top 500 Company Unilever chose to take Ning Xiang of Changsha as a production base to connect Shanghai research center and Guangzhou production center with low production cost.²⁸ Favorable transportation construction guided by the state has facilitated the CZT region to become a critical hinge to connect the East and West, South and North.

²⁸ Wen and Dai, ‘High-speed trains bring large bills to Hunan province’, Red Net, July 26, 2010, accessed at January 3, 2013, <http://zt.rednet.cn/c/2010/07/26/2018556.htm>.
<http://hn.rednet.cn/c/2008/11/21/1641458.htm> (Accessed March 7, 2012).

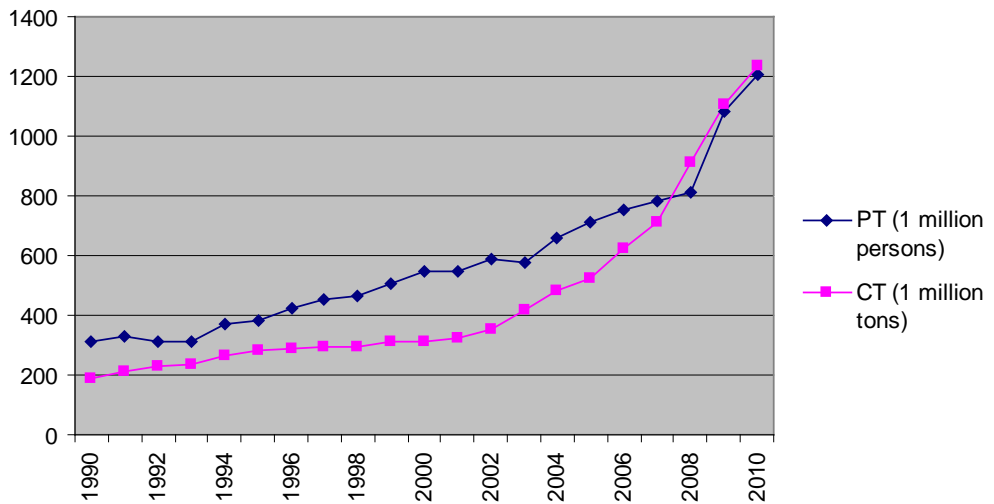

Figure 6. Change of PT and CT in the CZT, 1990-2010

5 EXPLAINING THE URBAN TRANSFORMATION IN THE CZT

To attempt an explanation on this urban transformation of the CZT EMR, a panel data analysis has been conducted to identify the factors and their relative importance. Industrialization has been recognized in the previous studies as the dynamic of urbanization. Therefore, in our analysis, industrial output per area (INDPA) is chosen as the dependent variable to indicate the most dramatic urban transformation in the CZT. The 8 indicators purport the contribution to EMR formation by the respective factors, i.e., (1) concentration of population, (2) economic capacity in terms of GDP per capita, (3) the extent of export-orientation of the economy, (4) the agglomeration economy which can be represented by the urbanization level, (5) the effect of investment, both domestic and foreign, and (6) transportation condition. These indicators were chosen through a broad-based review of the EMR literature, our quantitative tentative analysis and expert judgment. Although the new development of the CZT EMR started from 2000, we believe this development is based on incremental effect from the previous decade. Therefore, municipal data of 1990-2010 is used in this study. The sources of data and unit of measurement for each variable are given in Table 4.

Table 4. Possible and extendible variables of the database

Dimension	Variables	Code	Unit of Measurement	Data Sources	Year
Population	1 Population density	DEN	Persons per square km	1	1990-2010
	2 Population Change	POPC	%	1	1990-2010
Economy	3 GDP per capita	GDPPC	RMB US\$10000 per	1	1990-2010
	4 Export / GDP	EXP	RMB 100 million	2	1992-2010
Investment	5 Actual utilized FDI /km ²	FDIPA	US\$10000 per RMB 100 million	2	1991-2010
	6 Investment in Fixed Asset per capita	IFAPC	%	2	1990-2010
Urbanization	7 Urbanization level	URB	%	1	1990-2010
Transportation	8 Cargo transportation/km ²	CTPA	Tons per square km	2	1991-2010

* 1 = Hunan Statistical Yearbook 1991-2011

2 = China City Statistical Yearbook

1991-2011

Fixed-effects (FE) model is chosen to conduct for the panel data, as the chosen municipalities are fixed, i.e., all from the CZT. The rationale behind is that each municipality has its own individual characteristics that may influence or bias the predictor variables. This model could be run in the Stata Software.

The equation for the FE model is:

$$Y_{it} = \beta_1 X_{it} + \alpha_i + u_{it}$$

Where

– α_i ($i=1, \dots, n$) is the unknown intercept for each entity or section (n entity (section)-specific intercepts).

– Y_{it} is the dependent variable (DV) where i = entity and t = time.

– X_{it} represents one independent variable (IV),

- β_1 is the coefficient for that IV,
- uit is the error term

As a result, the final FE model is shown as Table 5. The p-value for F test (0.0000) is smaller than 0.05, suggesting that the model itself is significant. This model includes four significant independent variables (GDPPC, IFAPC, EXP and CTPA) and it explains 90.7% of the variance within each municipality and 84.6% for overall data. The value of rho means that 79.5% of the variance is due to differences across municipalities. The test for all $u_i=0$ further demonstrates that the fixed effect of each entity is very significant in this model. The predictive equation would be written as:

$$INDPA = 0.01 + 3.23(GDPPC) + 6.62(IFAPC) + 0.05(EXP) + 0.14(CTPA)$$

Table 5. The FE model results with INDPA as the dependent variable in the CZT

FE (within) regression with AR(1) disturbances	Number of obs =
152	
Group variable: municipality	Number of groups
= 8	
R-sq: within = 0.9074	Obs per group:
min = 19	
between = 0.4889	avg = 19.0
overall = 0.8456	max = 19
F(9,135) = 146.94	corr(u_i, Xb) = -0.1624
0.0000	P rob > F =

INDPA	Coef.	Std. Err.	t	P>t	[95% Conf. Interval]	
DENS	-.1808935	.1885198	-0.96	0.339	-.5537276	.1919406
POPC	-.0021389	.0247748	-0.09	0.931	-.0511358	.046858
URB	.0196133	.0589065	0.33	0.740	-.0968858	.1361123
NAGDP	-.0596445	.0406575	-1.47	0.145	-.1400526	.0207636
GDPPC	.3233593	.146551	2.21	0.029	.0335265	.6131921
IFAPC	.6616586	.1376344	4.81	0.000	.3894601	.933857
FDIPA	-.0247513	.083879	-0.30	0.768	-.1906381	.1411354
EXP	.0461394	.0229377	2.01	0.046	.0007757	.0915031
CT	.1372947	.042385	3.24	0.002	.0534703	.2211191
_cons	-.0044749	.0155358	-0.29	0.774	-.0351999	.0262501

rho_ar	.59207973		
sigma_u	.34242954		
sigma_e	.17431894		
rho_fov	.79418826	(fraction of variance because of u_i)	
F test that all u_i=0:	F(7,135) =	5.28	Prob > F = 0.0000

Source: calculated by the author.

In Table 5, the coefficient here is standardized, so its value enables us to make comparisons among the variables to determine their relative importance in the regression model. The higher the standardized coefficient is the higher relevance this independent variable has to the dependent one. In this model, only GDPPC, IFAPC, EXP, and CT (Transportation) are significant, in which, IFAPC (investment in fixed assets) is the most important, followed by GDPPC, CT and EXP. This indicates that domestic investment indicated by investment in fixed assets contributes mostly to the growth of industrial strength. Domestic demand suggested by GDPPC is much more important than global demand measured by EXP, though export is also significant to the model. Transportation indicated by CT has played a foundational role so it could serve as a production base for domestic and global markets.

Domestic investments especially those from developed regions of China has brought substantial amount of opportunities for the CZT's economic development facilitated by the government policies on industrial shift. More than 70% of them are invested in manufacturing sector. They are largely labor-intensive industries, i.e., electronic digital, food processing, textile and clothing, which have increased the demand for non-agricultural employment in this region and then increased the urbanization level. The development of transportation, e.g., the construction of high-speed railways, has paved the way for these investments from developed regions. It also serves as a critical hinge to connect the East and West, South and North of China, and hence to become the production base for the national market. Moreover, this industrial shift has facilitated the central region to attract processing trade industry from coastal areas and then significantly increased the amount of export in this region. All these factors are strongly directed by the central government, which indicates that in the inland area, governments from the central to local levels have played critical roles to facilitate the industrialization and urbanization and its connection to the more developed regions in China.

Although DENS, URB, POPC, GDPPC, FDIPA are not significant in this regression model, it does not mean all of them have no explanatory power on the variation of industrial strength. From the correlation matrix of URB with other independent variables, we can see that URB is strongly correlated with GDPPC and IFAPC (Table 6). This means that the entrance of GDPPC and IFAPC into the model would reduce the contribution of URB to INDPA.

Since they are highly correlated, URB might still have some explanatory power on the urbanization level through the contribution of IND. Similar theory could apply to FDIPA, as FDIPA is also strongly correlated with GDPPC and IFAPC.

Table 6. Correlation Matrix

	INDP A	Den s	POP C	UR B	NAGD P	GDPP C	FDIP A	EXP/GD P	IFAP C	CTP A
INDPA	1.000									
Dens	.368	1.000								
POPC	-.076	-.130	1.000							
URB	.742	.208	-.112	1.000						
NAGDP	.564	.457	-.235	.652	1.000					
GDPPC	.917	.247	-.101	.837	.626	1.000				
FDIPA	.818	.433	-.038	.698	.535	.860	1.000			
EXP	.298	.365	-.080	.446	.514	.286	.346	1.000		
IFAPC	.931	.298	-.064	.773	.564	.968	.916	.269	1.000	
CTPA	.843	.436	-.103	.665	.638	.764	.620	.316	.757	1.000

Note: Items in bold are not significant at 0.05 level.

Source: calculated by the author.

The results support the contention that domestic investment is the most significant factor for the CZT's urban transformation. We may also infer that the development of interior regions could be further explained as follows: (1) the development of communications technology allows the formation of urban-region (Castells (1993)). (2) In the new post-2000 era when domestic market is emphasized in China, another round of industrialisation is under way with substantial demand for infrastructure construction and that the CZT has become a favorable production base in terms of equipment manufacturing and electronic engineering for the national market (Chen, 2010) (3) The central government's support on industrial shift in China has

brought substantial amount of opportunities for the CZT's economic development. It has promulgated a series of regional plans with strong policy to direct industries from developed regions of China into the interior ones. (4) These policies are much welcome by local governments, as they deem the mode of urban-region as a way to improve their economic and industrial competitiveness. (5) The CZT is located in the central region of China. It can serve as a critical hinge to connect the East and West, South and North due to advanced development of transportation, e.g. the high-speed railways. All of these have indicated a top-down process of industrialisation, e.g. the industrial shift, spatial organisation, inter-region national transportation development guided from the central to local levels, instead of bottom-up process experienced in the coastal areas of China.

The results have also shown that aside from different nature of social and economic forces in interior regions of China mentioned earlier, driven forces for EMR formation are also not the same with the traditional ones in the coastal areas of China. According to this, our understandings of EMR concept in China might be divided into two stages: EMR I and EMR II (Table 7). EMR I, which locates in the coastal areas since the 1980s, is largely driven from bottom-up by "labor-intensive and assembly manufacturing" type of export-oriented industrialization taking advantage of a substantial inflow of migrants from interior regions. However, under the strategy of "Rise of Central China" and building domestic market guided from the central to local levels (top-down), EMR II, which locates in the interior region since the 2000s, is largely driven by the domestic force as well as global forces in which the extent and strength of the former force might surpass those of the latter one. In the meantime, the construction of transportation lines has paved the way for more inter-regional interaction to serve domestic and global markets. It is not labour-intensive and low value-added light industry dispersing throughout the whole region and causing high energy consumption and intensive environmental pollution as in the coastal areas, but the technology-intensive and high value-added industry concentrated on development districts bearing the government's expectation to guide the industrial development toward energy-saving and environmental friendly. Moreover, the local population including backflow of labour force might imply a different development mode ahead in the ongoing urbanization process compared to that in the previous stage in the coastal areas.

Table 7 Comparisons of EMR I and EMR II

	EMR I (1978-2000)	EMR II (Post -2000)
Growth region	Coastal China	Inland China
Drivers	FDI Export Opening	Domestic investment Domestic market “Rise of Central China”
Processes	Bottom-up	Top-down
Growth Features	Trade intensive and export-oriented Labor-intensive, low value-added light industries High energy consumption and intensive environmental pollution Uncoordinated industry growth Large amount of unskilled immigrant labor	More inter-regional interaction and less trade/ export intensive Higher value-added high-tech industries Emphasis on energy saving and environmental friendly Industries coordinated in development districts Mostly local population including “backflow” of labour force

Source: compiled by the authors.

6 DISCUSSIONS AND CONCLUSION

In the backdrop of a new global and national environment, domestic demand and the new strategic emphasis on “low carbon” have already been taken as crucial strategies in urban development in China since 2000. Along

with the enhanced attention of the state on the development of “Central China” and the designation of a trial zone to build a “two-oriented” society in the CZT, hectic growth in domestic investment in basic infrastructure like road and high-speed railway construction, and political preferential measures have been bestowed by the central government onto Hunan to foster its industrialization and urbanization which have led to concentrated growth in the core of the province, i.e., the formation of the EMR.

The CZT has experienced a dramatic growth especially since 2000 in terms of population, GDP, export, FDI, IFA and transportation similar to that in the coastal area (Sit and Yang, 1997). However, the nature of this transformation has shown some differences. EMRs in the coastal areas were driven spontaneously by a substantial inflow of FDI and migrants and outflow of exports of ‘labor-intensive and assembly manufacturing’. In the inland area, governments from the central to local levels have played critical roles to facilitate the industrialization and urbanization and its connection to the more developed regions in China. The industrial growth is directed in the development districts which enjoy different preferential policies depending on its level and prefer different types of enterprises to enter. More high-tech products have therefore been encouraged to produce here composing a significant amount of industrial output. Industrial shift initiated by the central government has provided an efficient means for the CZT to attract a predominating amount of domestic investment from other provinces which has far surpassed the amount of FDI. Facilitated by the rapid development of national high-speed railways, it has tremendously increased the passenger traffic and cargo traffic and economic connection with coastal area of China.

A fixed-effects model was further conducted to examine the potential distinct mechanism of EMRs in Interior China. It is found that economic transformation of the CZT EMR is mainly driven by GDP per capita, investment in fixed assets, transportation and export. Located in the central region of China, CZT EMR lacks the geographical advantage to attract foreign capital. Unlike the traditional EMRs in coastal China and Southeast Asia, it is domestic investment measured by investment in fixed assets per capita and domestic demand indicated by GDP per capita that take the predominant roles in its growth of industrialization and hence urbanization in 1990-2010. Export is also a significant factor but to a much lesser extent, although it has gained a fast growth in the latter period of 2000-2010. The results suggest that these EMRs in Central China that seem to gain significance only since 2000 are spurred by both globalization and domestic forces. Especially domestic investments in China which are rising quickly since 2000 have become new forces compatible to global forces as in the coastal area in driving the formation of EMRs in China, particularly so in its interior and western regions. The CZT EMR is a case in point.

In summary, the CZT EMR study has indicated a new stage of EMRs in China in the new global and national environments: EMR II unfolded since

2000 compared to EMR I in the coastal areas of 1980-2000. However, this study has not covered the post-2000 development of the Coastal EMR (EMR I new development, or EMR I(b)). These EMRs are also rapidly changing in face of the changing globalization and China's domestic environment. It is most appropriate to view their post-2000 development as a second stage of EMR I or EMR I (b). They should form a separate future study which will contribute to our further and more comprehensive understanding of the EMR concept.

REFERENCES

- Castells, M. (1993). "European cities, the informational society, and the global economy", *Tijdschrift voor economische en sociale geografie* 4,247–257.
- Chen, M. (2009). "Comprehensive Evaluation and the Driving Factors of China's Urbanization", *Acta Geographica Sinica* 64 (4),387- 398.
- Chen, Ming (2010). "Chinese Urbanization Strategy from the View of Transformation", *Urban Studies* 10,1-9.
- Dai, L., V. F. S. SitYanting Zheng (2015). "A new pattern of Extended Metropolitan Regions (EMRs) in China: A case study in the Changzhutan (CZT) EMR", *International Development Planning Review* (Forthcoming).
- De Mattos, C. A. (1994). "The moderate efficiency of population distribution policies in developing countries." In *Population Distribution and Migration* (Eds), Proceedings of the United Nations Expert Meeting on Population Distribution and Migration. New York: UN Population Division.
- Dicken, P., ed. 2007. *Global Shift: Mapping the changing contours of the world economy* (5th edition). New York: Guilford Press.
- Firman, T.I. A. I. Dharmapatni (1995). "The emergence of extended metropolitan region in Indonesia: Jabotabek and Bandung metropolitan area", *Review of Urban and Regional Studies* 7,167-188.
- Forbes, D. (1997). "Metropolis and Mega-urban region in Pacific Asia", 5,457–468.
- Li, H. T. (2008). "Discussion on the Formation Mechanism of the Metropolitan Area: Case in Chengdu, Sichuan Normal University, Sichuan.
- Lin, G. C. S. (2001). "Metropolitan development in a transitional socialist economy: Spatial restructuring in the Pearl River Delta, China. ", *Urban Studies* 3 (38),383-406.
- McGee, T. G. (1989). "Urbanisasi or kotadesasi? Evolving patterns of urbanization in Asia." In *Urbanization in Asia: spatial dimensions and policy issues*, edited by F. J. Costa, A. K. Dutt, L. J. C. Ma and A. O. Noble. Honolulu: University of Hawaii Press.
- McGee, T. G.C. Greenberg (1992). "The emergence of Extended Metropolitan Regions in ASEAN: towards the year 2000", *ASEAN Economic Bulletin* 1,22-44.
- McGee, T. G., G. C. S. Lin, A. M. Marton, M. Y. L. WangJ. Wu, eds. 2007. *China's Urban Space: Development under Market Socialism*. London: Routledge.
- Ning, Y. M. (2011). "Definition of Chinese Metropolitan Areas and Large Urban Agglomerations: Role of Large Urban Agglomerations in Regional Development", *Scientia Geographica Sinica* 31 (3),257-263.
- Ou, Xiangjun, Feng ZhenYongdong Qin (2008). "Study on compression level and ideal impetus of regional urbanization: The case of Jiangsu Province", *Geographical Research* 27 (5),993-1002.
- Shen, B. (2007). "The reason, problems and strategies of the western Urban Clusters", *Review of Economic Research* 64,22-25.

- Shen, J. (1999). "Modelling regional migration in China: estimation and decomposition", *Environment and Planning A* 31,1223-1238.
- Shen, J. (2006). "Understanding dual-track urbanisation in Post-Reform China: Conceptual framework and empirical analysis ", *Population Space and Place* 12,497–516.
- Sit (2005). "China's Extended Metropolitan Regions: Formation and delimitation", *International Development Planning Review* 27 (3),297-332.
- Sit, V. F. S.C. Yang (1997). "Foreign-investment-induced exo-urbanization in the Pearl River Delta", *Urban Studies* 4,647-678.
- Soegijoko, B. T. S.B. S. Kusbiantoro (2001). "Globalization and the sustainability of Jabotabek, Indonesia." In *Globalization and the Sustainability of Cities in the Asia Pacific Region*, edited by F. C. Lo and P. J. Marcotullio. New York: United Nations University Press.
- Wang, F., H. WuQ. Wei (2006). "A Strategic Study on Development Zone in Our Country Nowadays", *Areal Research and Development* 1,23-27.
- Wang, Y., X. BaiM. Cai (2009). "China foster the rise of Central responding to Global Economic Crisis", *Police Research & Exploration* 1,1.
- Xiao, M.M. Gu (2009). "High-speed train change China's economic landscape" , 21st Century Business Herald.
- Xu, X. Q.C. S. Zhou (1994). "Study on the formation of Pearl River Delta EMR", *Urban Problems* 3,3-7.
- Yan, X. P., J. GuoY. B. Hu (1997). "A study of the dynamics of Guangzhou, Hong Kong, Macao megalopolis", *Geographical Research* 16 (2),22-29.
- Yao, S. M. (1992). "The feature, type and spatial structure of our Urban Cluster", *Urban Problem* 1,10-15.
- Zheng, Y. T. (2009). *China's Mega-urban Regions: Spatial Restructuring as Global Manufacturing Platforms*. VDM Verlag.
- Zhou, G., C. TangX. Zhu (2002). " A study on the form mechanism of the urban system in Changsha-Zhuzhou-Xiangtan", *Human Geography* 3 (17),13-17.



NO.108

In Search for Identity, a Qualitative Comparison of Some Urban Development Examples from UAE

Rim Meziani^{1*} and Apostlos Kyriazis¹

1 Abu Dhabi University

**Corresponding Author, Email: rim.meziani@adu.ac.ae*

Key words: UAE, morphology, sustainability, identity, neighbourhood model, Gulf cities, new urbanism

Abstract: Our paper tries to understand what would make the urban development in UAE achieve the balance between the traditional Arabic forms and the western imported morphology to achieve a character that reflects the identity of the city. Through qualitative comparison of some local urban development examples, the authors will show how these experiences tried to combine between the contemporary engineering, the architectural fantasy and the traditional Arabic urbanism.

With the ambitious vision of UAE to create modern and sustainable cities, through the application of standards and codes, the success cannot always be guaranteed without referring to both traditional morphology of Arab cities, local architecture and international examples, either the classical reference such as the neighborhood model, or the walkable environment created by the new urbanism and smart growth, or learning from the unsuccessful experience such as the urban sprawl.



NO.

Identifying the Evaluation Factors of Smart Tourist Attraction: An Investigation from Tourist Perspective

Xia Wang^{1*}

1 Nanjing University

** Corresponding Author, Email:*

Keywords:

Abstract:



NO.

The Tempospatial Fragmentation of Leisure Activities in the Information Age and Its Influencing Factors

Guangliang Xi^{1*} and Feng Zhen^{2*}

1 Nanjing University

2 Nanjing University

** Corresponding Author, Email: xigl022@163.com; zhenfeng@nju.edu.cn*

Key words:

Abstract:

Environmental Planning &
Green Building

NO.20

A Registration System for Preventing/Mitigating Urban Flood Disasters as One Way to Smartly Adapt to Climate Change in Japanese Cities

Sampei Yamashita^{1*}, Sadanori Matsuda¹, Ryoichi Watanabe², Yukihiro Shimatani³, Toshiyuki Moriyama⁴, Hironori Hayashi³, Hiroki Iyooka², Teruki Hamada², Terukazu Yamashita⁵, Kumiko Kakudo⁵ and Tomoko Minagawa⁶

1 Department of Civil and Urban Design Engineering, Kyushu Sangyo University

2 Department of Civil Engineering, Fukuoka University

3 Department of Urban and Environmental Engineering, Kyushu University

4 Department of Socio-Environmental Studies, Fukuoka Institute of Technology

5 NPO Minamihata Dam Chosuisurukai

6 Department of Environmental Management and Planning, Kumamoto University

** Corresponding Author, Email: samp@ip.kyusan-u.ac.jp*

Key words: Watershed management, urban flooding, rainwater retention, smart adaptation

Abstract: Intensive rainfall and frequent inundation have become a serious problem in urban areas all over the world. Climate change and heat island effect may be the cause of the phenomena. Widespread impervious pavement/surface of the ground makes things worse. In order to promote an effective river basin management in urban areas and reduce runoff, a registration system called “Safety Plan for 100mm/h-Rainfall (100mm/h Anshin Plan in Japanese),” a scheme for preventing and mitigating inundation caused by extremely heavy, short-term rainfall (such as 100mm/h-rainfall) was established in April 2013 by the central government in Japan. This study carried out a questionnaire survey to examine how municipalities effectively utilize the registration scheme for their watershed management. The findings obtained are as follows: 1) All the targeted rainfall intensities are below 100mm/h, so the name of the scheme does not fit well with the plans. 2) In association with the registration, watershed management measures including main storm-water drains and small-to mid-sized rainwater retention/infiltration facilities and damage mitigation measures such as hazard maps and risk/safety information distribution are progressing. 3) There are municipalities who have started/revised subsidizing installation of private rainwater retention/infiltration facilities in association with the registration; however, as it now stands, municipalities in general are not so active in promoting runoff reduction by subsidizing private facilities. 4) The registration does not necessarily strengthen public awareness for risk management. 5) There are three patterns in disseminating rainwater retention systems: public-

oriented, private-oriented and both. 6) In the plans emphasizing public works for runoff reduction, public involvement is not so active, whereas in the plans devised with relatively new committees of watershed management, public involvement as well as private retention activities tend to be active. 7)

For flood-disaster mitigation, the municipalities who registered their Safety Plan for 100mm/h-Rainfall tend to utilize hazard maps to facilitate/strengthen self- and public help and educational activities to drive mutual help. 8) Relevance between the coverage of storm-water sewer system and effectiveness of the scheme, clear description of how to prevent inundation, administrative leadership, enhancement of civic collaboration, and collaboration between river and storm-water drainage systems' administrators need to be addressed more.

NO.23

Innovation on Modular Planting Containers of Vertical Greening

Shang-Jen Chen^{1*}, Dar-Wu Chen^{2*} and Kuang-Hui Peng^{3*}

1 College of Design, Taipei Tech, National Taipei University of Technology

2 Department of Architecture, National Taipei University of Technology

3 Department of Architecture, National Taipei University of Technology

** Corresponding Author, Email: darwu@mail.nou.edu.tw*

Key words: Vertical greening, modular planting container, innovation, greening and planting, three segmentation method

Abstract: Today Most consumers Used by the old version module Irrigation sprinkler systems and technologies, To use tap water and groundwater mode of provision of building facades, Surrounding fence and The sidewalk Ground Plant Required moisture, And unable to effectively Solution Water-saving problem. In this paper Research purposes Is from Energy-saving Point of view, on rain-fed circulation manner, To be able to come up with a set of innovative modular planting containers invention, Taking into account Environment and energy saving benefits. This article First of all Review Analysis Related In two segmentation methods as a solution Energy conservation issues literature, after a study found two Segmentation methods still lack a system function, and unable to effectively solve the water problem. Therefore In this paper, Consists of ten kinds of innovations in systems, Reconstituted Three segmentation method Continued rain water harvesting cycle and cycle in plants using rainwater for irrigation, Discover Can be reached Green and energy-saving benefit. At last Summary Innovative design The Three segmentation method, Proposed a set of Modular planting container Invention, Not only Can be solved Traditional irrigation Automatic Water spray systems Problem, Also make Planting Plant term sustainable access Rain Water irrigation, Reach Green Environment and Energy efficiency.

1. INTRODUCTION

Consumers of new buildings under construction in the surrounding Hedgerow outside, Exterior side of the surrounding wall hanging hangs on triangle plastic box, Then had fixed planting cassette body, called in this way grow plants, in fact, place plants. The sidewalk side by using the

traditional way of growing plants, Used irrigation and planting systems, water supply irrigation in planting of literature and field research found that the plants irrigation system, Most of the waterwheel use fixed plastic piping to sprinkler irrigation or water supply plants for irrigation use, and water after a reservoir treatment and sent to a water purification plant, and used by consumers to turn on the tap switch, This process has already cost some energy, (Ming-Chin Ho, 2013). Extraction of underground water supply plants for irrigation use, external sprinkler system currently used in new construction begun excavation site, extraction of underground water, most released ditches and exile on the road, (Ming-Chin Ho, 2013). Some delivered to external exile, pedestrian and road traffic safety and water. Generally used by older plants irrigation systems, modular irrigation methods used by most external spraying of plants within a container or pipe niche play or arranged in a row to draw water out of holes so that water drips or water spray irrigation plants. Another way to irrigate plants, The tree planted on top of the soil, water pipe joints connected switch apparatus and switching equipment has set the time function, Set the time required arrival time, will automatically rotate the body control water spray formed by cycles of time spraying plants. Another newer technology using plastic pipes Assembly plastic nozzle mounted on the wall, (James Lim,2014) , And fittings plastic or chemical materials, such as plastic materials, in periods of high temperatures, Plasticizing agent and released by lead, mercury and plasticizers substances, long-term release of plasticizer, increased environmental and human hazards. New buildings were constructed with recycled rainwater recovery ways of thinking or rain is insufficient, add tap water before using.

Upon completion of the new buildings constructed, reduce the amount of underground water and tap water, using rainwater to irrigate plants. Think innovative approaches, From traditional modular irrigation plants, looking for methods to import planting system, The planting of the plants, think of a new modular method of planting containers, preliminary ideas in creative thinking (Charles Landry, 2013) Manner and may cycle through rain-fed, and modular planting containers viable and innovative thinking. General legacy modular planting containers used by the plastics chemical material forming, exterior walls or surrounding wall and sidewalk, With tap water to irrigate plants sprayed walls, damp problems touched on sidewalks or the ground, causing people walking safety. Rainwater collected by the reservoir, filter dirty rain water by electricity and clean running water delivered to users using this process is the increased consumption of energy, (Ming-Chin Ho, 2013).In order to reduce energy consumption, this study will be landed by rainwater circulation, Change modular planting container molding of plastics chemical material used by the construction and recycling and reduced touch the wet ground, Also to reduce the waste of water resources, so that rainwater utilization of resources, Creating exterior

sidewalk side and lateral walls or surrounding Hedgerow plants with rainwater collection and irrigation cycles, Formation of energy conservation and creating green landscape, security and greening effect, in practice the documents look carefully at the construction site, This study found that in old and new buildings construction of planting container, (James Lim, 2014) , Short relies on external building walls or surrounding fence Assembly dominated by metal frame structure, assembled in a box to plastic chemical suction plate, Water-absorbing panels and digging device implantation planting container planting, and then assemble plastic pipe and nozzle combination formed from water export controls, modular irrigation cycle is formed.

Observation methods, (Zhang Jiahao, 96), For old and new buildings short wall or surrounding Hedgerow outside into the plastic chemical suction plate, Container planting need replantation nailed planting container open again after a power cycle, Modular planting in containers or plastic sprayed chemical water-absorbing panels and plants get water, From this observation, using sprinkler systems, General legacy or plastic planting containers of chemical materials Figure IX, Turn on the tap switch, internal waterways through pipes, water by the drop hole water-absorbing panels and plants get water, This planting container components to manufacturing-related chemical materials, PP/PE plastic container mix the soil cannot be remanufactured or recycled after cleaning after use difficulties, Answers to questions no recovery after 10-30Years, (James Lim, 2014) , Cannot be used permanently, In National Taipei University of Technology. And The Regional Department at National Professor University, (James Lim , 2014) . In accordance with the plastic figure 10, Principles of chemistry, in hot and cold causes degradation of the material, Cannot be reproduced or plastic use, recycling difficult or lead to recovery, formed garbage can only burn treatment, Affecting air and dust impacts land and edible plant chain, causing secondary cancers on the body after consuming plant chain damage and fallout environment from human skin irritation and respiratory problems.

Observation statements and questions to practice positioning solution method is proposed, based on lateral thinking and reflection on the vertical integration, Creative thinking about the method of lateral thinking above the line segment, (Zeng Nianmin, 2014), Found the problem statement positioning and issues proposed way to solve the problem, Lateral thinking and reflection on the vertical integration of creative learning in practice, Figure 1 second segmentation method of this study form a innovation context diagram, (Zeng Nianmin, 2014), Innovative techniques to achieve new ideas, Lateral thinking method and line segment. The upper old elements from legacy produce new products or ways of thinking. As a new element in the Middle, transforming the upper old mindset, then below the subdivision method produces a new way of thinking, So called

segmentation method is also known as the second partition method product innovation, (Zeng Nianmin, 2014), Separated by more than two methods in vertically integrated way, above and below the associated link, After the screening, use Figure 1 the feasibility of innovative problem solving, effective and easy process integration and innovation to succeed, With lateral thinking methods into practical innovation invention patented technology, (Zeng Nianmin, 2014), The original segmentation, form a innovation situation status, problem solving can be clear, (Zeng Nianmin, 2014), Bringing the innovative approaches to new thinking, Figure 1 horizontal line segment on the thinking, Recycling expansion of invention and inherent abilities (Ness,Roberta B, 2012) .

Look to more explicit exterior walls or the green issues surrounding wall and sidewalk side. Original 1 research methods form a innovation found in context, Innovative technology thinking maps as in figure a do not solve the problem, adds new elements of innovation, (Zeng Nianmin, 2014), Situated within the framework of existing problems and innovation thoughts cannot be solved, Need innovation to continue study finds inherent to the update method or more specifically to jump off the original thinking, (Tim Brown , 2012) ,Research ,segmentation, Longer placed increased to partition as shown in Figure II, innovative thinking, in the place thinking, Three Segmentation ,Elements of the innovation system and methods to achieve new technology thinking maps, So called Three segmentation method Figure 2, Which found new problems in the innovation framework, Three application of segmentation method in Figure 2 to identify problems and , And again finds still use PP or PE recycled plastic planting containers to be cleared and then manufactured already fragile, Then use the difficulties and the difficulties mixed with higher softening agent, induced higher levels of chemical poison, life issues, 2-3 years Material ageing. Application of three-segmentation method, found that modular other methods can be used instead of plastic planting containers of chemical materials, water-absorbing panels,For future environmental pollution-reduction,so three segmentation method to find the problem,initially found a possible lack of application, can form a innovation way, Therefore found the opportunity to solve the problem, (Ness, Rober ta B, 2012) ,The innovation of this research and applications make up the three segmentation,Form in Figure 2 to solve the problem more clear direction and practical modular planting containers invention possible.

Study to observe the application of traditional technologies in innovative ways to achieve new knowledge maps, Observed traditional building a perimeter fence cannot long to construct modular planting containers, In the study From, (Zeng Nianmin, 2014), Oral and documentary discovery to two segmentation methods form a innovation scene graph, But reforming the old thinking, Thus creating Three Segmentation method In Figure 2, Effective exterior wall, surrounding wall and side of the sidewalk greening

needs innovation, Modular study motive of planting container, Urban wall Lei or side of the sidewalk outside the building formed green and the external walls of buildings under construction or surrounding wall and side of the sidewalk outside the art style, Form the exterior styling of art of urban greening in creative new ways of thinking and creativity. In front of the lateral thinking method is applied above the line of thinking segment, having a new element technologies that could be used, Elements that are not considered and lack of new thinking to find future problems, below the new elements line, Integration of new thinking, may find future problems, Such as materials recycling and remanufacturing and The next 10years After the environmental protection issues. (Kenichi Sugihara, 2015) .

To third-tier Division and then to the middle of the new element technologies that could be used to form a new method of lateral thinking, Below the line on new thinking and reform the old mindset of the new elements in the middle and upper, New ways of thinking, So called Three-wire Segmentation methods Short title For Three Segmentation method As shown in Figure 2.

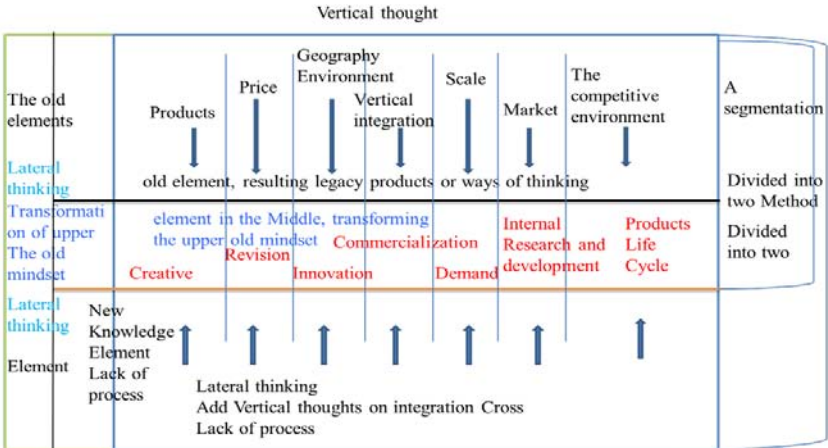

Figure 1. spur thinking method on underline split (two way)

The Three Segmentation method an introduction to form creative lateral thinking, Innovation demonstration contains an introduction to patents, copyrights, the actual importance of innovative methodologies, innovation needs to take risks, Worry more about how perception can be creative, meet innovation, (Ness, Roberta B, 2012), Form a unitary construct innovative drawings and Future physical practice, Innovation survive and give rise to growing strength, enhance the ecological environment, fight environment of cement, Reduction of cement buildings, with their Green thinking, makes green plants survival, Who need innovative green building innovation environmental component, In The Three Segmentation method in Internal and external cooperation into lateral thinking, When innovative products in

the integration of external knowledge innovation ability, (Ness, Roberta B , 2012), Integrated in the overall green plan, around buildings to get synergies of creative opportunities. When the old-style methods of creative thinking could not be expect a substantive synergies, Considerations lead to new research methods, in inventions, Must have insight into the diversity of innovation and long term prosperity, With moderate graphics and text descriptions of related technologies to produce innovative contribution, (Zeng Nianmin, 2014), When the surrounding wall or walkway around the green innovation ecology, Segmentation method of three innovative sources might formed creative approaches and prospects for the future of building external walls or surrounding wall, Planting green on the side of the sidewalk system problems, If application Three segmentation method Innovative ways of thinking, On the outer wall of the next building or surrounding Hedgerow planting and Sidewalks around the planting of green issues, The new approach may have the opportunity to effectively address green issues.

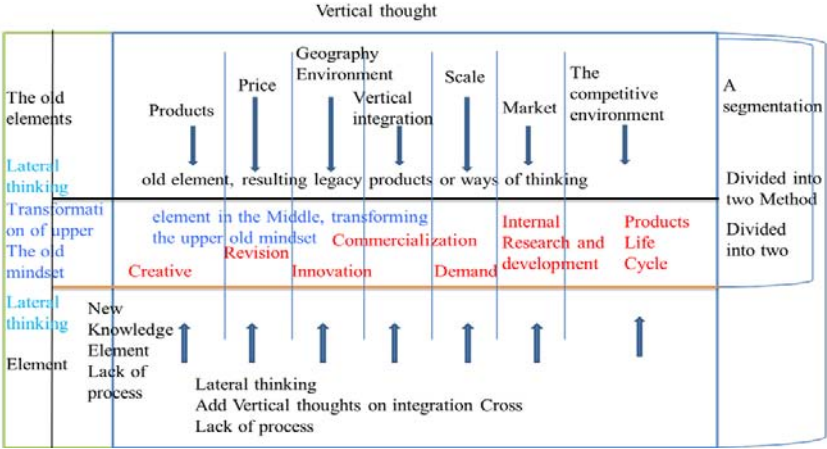

Figure 1. spur thinking method on underline split (two way)

The Three Segmentation method an introduction to form creative lateral thinking, Innovation demonstration contains an introduction to patents, copyrights, the actual importance of innovative methodologies, innovation needs to take risks, Worry more about how perception can be creative, meet innovation, (Ness, Roberta B , 2012), Form a unitary construct innovative drawings and Future physical practice, Innovation survive and give rise to growing strength, enhance the ecological environment, fight environment of cement, Reduction of cement buildings, with their Green thinking, makes green plants survival, Who need innovative green building innovation environmental component, In The Three Segmentation method in Internal and external cooperation into lateral thinking, When innovative products in the integration of external knowledge innovation ability, (Ness, Roberta B , 2012), Integrated in the overall green plan, around buildings to get

synergies of creative opportunities. When the old-style methods of creative thinking could not be expect a substantive synergies, Considerations lead to new research methods, in inventions, Must have insight into the diversity of innovation and long term prosperity, With moderate graphics and text descriptions of related technologies to produce innovative contribution, (Zeng Nianmin, 2014), When the surrounding wall or walkway around the green innovation ecology, Segmentation method of three innovative sources might formed creative approaches and prospects for the future of building external walls or surrounding wall, Planting green on the side of the sidewalk system problems, If application Three segmentation method Innovative ways of thinking, On the outer wall of the next building or surrounding Hedgerow planting and Sidewalks around the planting of green issues, The new approach may have the opportunity to effectively address green issues.

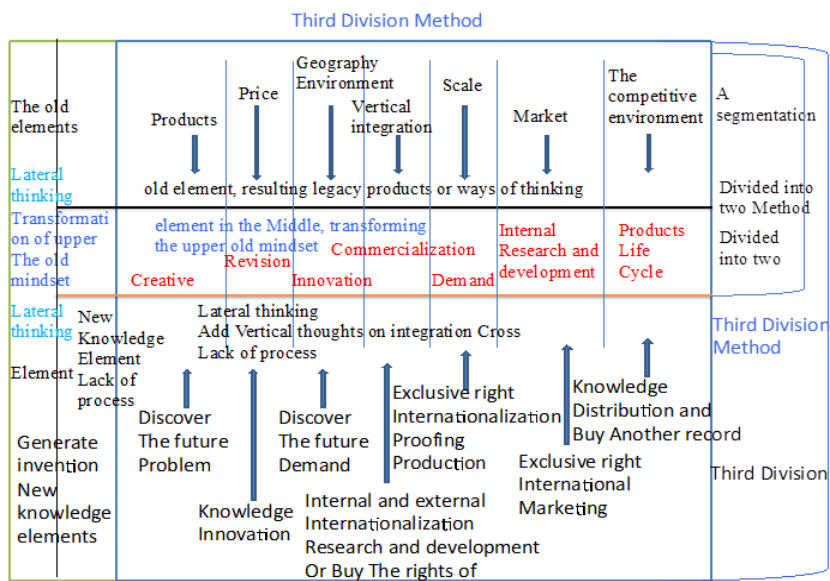

Figure 2. Three segmentation method

2. REVIEW OF THE LITERATURE

Research of building exterior wall or surrounding Hedgerow plants used by the outside literature, field survey found that United Kingdom due to large green spaces, Outside of the exterior wall of a building or surrounding Hedgerow plants used by very few, most of them with the traditional construction method. Found in the literature, Japan city building sites vary in size, General Surrounding lateral wall small part painting or exterior walls outboard use surrounding iron fence As shown in Figure 3, Figure 4, Used by the Plants are so scarce that built part of the ladder to the platform

used by growing plants. In Taiwan cities, such as Taipei City because of building size is slightly different, Built using the surrounding Hedgerow outside The hanging plastic cartridge used by planting or outside painted, has yet to find new technologies, Composition team of exterior house plants and professional operators and the city life, Look forward to more green sources, so composition team of building external wall construction to form walls of plants, Due to community demand and professional building managers continued to explore new technologies, reach more exterior walls and building fence outside the walls of green innovation.

2.1 Explore Building external wall Green technology

General sources of technologies and methods of creative thinking, on exterior walls or surrounding wall and sidewalk outside planting of green technology and creativity to effectively solve the problem, Resulting in new product development and innovation motivation The old element New ways of thinking Recreation products, James Lim 2014, Via creative thinking to existing elements, using a new method of innovation, (Zeng Nianmin, 2014), The motivation for this study as shown in Figure 2.

2.2 the surrounding Hedgerow's green building discussion

Figure 3 on Septe Figure 3 on September 21, 2014 In Japan, Tokyo, Asakusabashi sites new generation marked maps of field research in a new building near the station, Because the construction fence is not painted Figure and not use the container planting green methods. Marked in the new buildings of the surrounding fence on the left map, notice notice of building and surrounding Hedgerow is not green, Figure on the right side as shown in Figure 3 is not planting street trees and people. Evolution of Japan near Asakusabashi station sites in new generation in building of roads and new buildings no fence with green plants, September 21, 2014 Seen in this building, Take solar roofs to reduce the use of electricity demand sales-oriented, Field investigation of the September 21, 2014, as shown in Figure 4, Japan Tokyo AIM outside the warehouse wall as green and using a container planting greenery and warehouses, Surveys found President of AIM into the warehouse for about 2 minutes the body clothes were all wet, Within the motor vehicle being launched at temperature of 42 degrees. If plants need a lot of water irrigation, Visit AIM outside President, If plants need a lot of water irrigation, exterior landscaping and container planting greenery, because no one management situation, Plants grow very quickly wither. Observing Japan States in this case, surrounding fence was not

demanded for afforestation, So the creator company, (James Lim , 2014) ,Promotion of own products or spread across the modular construction method for planting containers PE or PP material to plastic chemical containers, In the water-absorbing panels made of water planting, (James Lim, 2014) , In Singapore after its use extended to Taiwan only received a small part as shown in Figure 10, Currently remains found from Japan and the United Kingdom and the United States advanced the use in new buildings and surrounding wall and sidewalk use. On September 21, 2014, as shown in Figure 3 figure in Japan field research, United Kingdom and the United States advanced national literature, chemical plants with plastic containers in the plants is not much, Especially in Japan after the use of recycled waste, need to pay to recycle, recycling costs are very high, Are subject to demolition expert certification application requires a license, so the wages are very high, in order to reduce costs to customers, rare used to be green.

2.3 Sidewalk greening of buildings surrounding discussion

Peripheral in the design of buildings to the sidewalk with greenery, in the design and construction of structural system of mixed reality, Redesigning Leadership, (2011),Their choice of construction materials and environmental design collaboration in the area of architectural innovation. Innovation building in the old perimeter sidewalk greening, Green has not yet found a large quantity of sidewalk, Figure 5 National Taipei University Base Lake Road, Neihu, Taipei, six walkways elevated green at the edges of the new building,has not yet been green Did not think the new outer walls or surrounding Hedgerow as a green building, Sidewalk greening plants and construction of more sporadic in the creation of new green tree planted on the pavement around the building, Plant activation of formation of living environment and closer to human existence. Figure 8 Taipei's Chunghsiao Road, new North road pavement, sidewalk traditional construction, Cement placed above the bottom edge of a cement block and brick construction, Pan- side-by-side now and then after repairing brick with sand, brick edge to fill cement buildings, all this structure is superior to the concrete progress. Think cement on the sidewalk, actually lacks the Green road green plants on the sidewalk in front of my foot.

2.4 Construction Plenty of green architectural thinking

Woods and natural plants that are not building, new construction and destruction of the old land and the disappearance of green plants,

architecture planning design will be in front of the old land-planning pavement for green plants and the degree of innovation of the exterior wall of green plants, On greening of urban buildings, forming flexible inspired residential green forest with long-term development goals, has been gradually formed the people's demand, plants built in new buildings in the surrounding forests and on roads and sidewalks, Flowers plants trees and beside the same living, such as Figure 9 protists and plants, (Tim Brown . 2012) , With creativity and innovation into new opportunities.

New exterior walls or surrounding Hedgerow into a Green thinking, Plants will be built outside the walls and associated buildings or enclosed Hedgerow outside perimeter sidewalk and planting of greenery, form a symbiosis between the environment and plants for human habitation.

In literature and field investigations have not found using three methods, create green plants around reflections on the life of the building, (Charles Landry , 2013) ,Using new and innovative thinking to create a viable development, By observation of the field investigation and consideration of literatures, Expected to live in cities, roads and buildings around a large number of the Green, creating a large number of new exterior surrounding wall and sidewalk landscaping vision or, With innovative planting containers can be incorporated into the new building and a new road, the pavement, creating a lot of green, Therefore this study could take modular planting container to new compositions contribute is the aim of the present study. In old-style composition technology of planting container, used on the ground level of the old creative modular planting container for laying on the ground for planting containers Figure 9 Pu design method of plane on the ground, No water, no power setting water cycle water circulation. Composition of plants in container planting methods, Did not reach the basic innovation of water circulating system, no green planting containers. Figure nine old ground planting containers.



Figure 3. On September 21, 2014 Asakusabashi station sites Tokyo a new generation field



Figure 4. field investigation of the September 21, 2014 the AIMC Corporation, Tokyo



Figure 5. National Taipei University of technology

Figure 6. base Lake Road, Neihu Taipei, new building sidewalks



Figure 7. Taipei's Chunghsiao Road, new North road pavement

Figure 8. Protists forests and flowers (Right 2 figure)

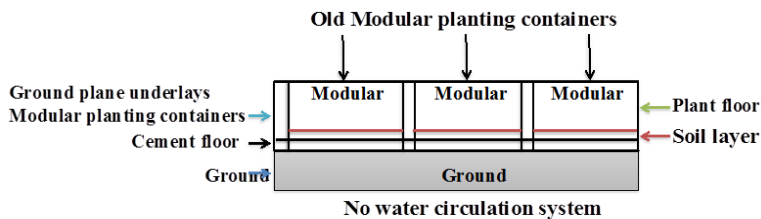

Figure 9. old make up ground planting containers

3. RESEARCH METHODS

Three segmentation method based on Figure 2, 11 to ten kinds of innovations as shown in Figure 12, Ten kinds of innovation and creativity in the process in practice, (Vijay Kumar , 2013) ,Rather complicated method is made in the literature, a process is creatives cannot at first understand the application process. Main product performance in flow,

Finishing ten innovative product performance the research process, the removal of ten kinds of innovations, (Vijay Kumar , 2013) ,One of the processes As shown in Figure 13. One of the most important processes of ten innovative methods of series b Division insufficient to segmentation of three innovative three-segmentation model as shown in Figure 11, by the old-fashioned elements composed innovative technology thinking to creative thinking, (Ken-iti Ohmae , 2009) , Exterior walls or surrounding wall and sidewalk greening in in-depth study has not discovered related technologies or systems.

This study three methods to ten removal processes in the innovation system, Produce new thinking on system innovation results. Innovative approaches to three segmentation study has found, mainly in the complementation of rainwater circulation system with tap water, Use floor below the water circulation system can supply plants for a living, but when using fences and walls, the flow of water supply plants for their livelihood, refer to the invention of graphic content, Three segmentation method in Figure 2, Figure 11 and 13 innovation processes, Changed figure nine old ground planting container method, so that the research has invented a new system, a patent of invention results, Three segmentation method and system of ten kinds of innovations, new modular planting containers, Building sidewalks and exterior walls or surrounding Hedgerow planting green system, an effective solution to exterior walls or surrounding Hedgerow planting and pedestrian tunnel planting of green issues, contribution to the green kind of synergy, Studies with moderate invents the graphic description of the content. With proprietary green experts (Professor Kuang-Hui, Peng and team 2014) , Planting greenery system and the innovation of this research for planting containers, Discussion on the greening of Figure 10 plastic chemical materials in the literature using the process, Still did not find this study related systems, due to the effectiveness of innovation, Three segmentation method for system integration and innovation of practice, therefore found to create modular planting container feasibility component feasibility of synergies.

Figure nine of ten kinds of innovations, (Vijay Kumar , 2013) Three methods after harvesting on Figure 11 innovative segmentation of new elements in the process. Then three segmentation method for generating new ideas, figure of ten using three methods to break through ten innovative processes, with old element formed on the top middle elements, Reach beneath new segmentation method of creation of three building process to create modular innovation consisting of three methods of planting container, Can be an effective solution as shown in figure IX legacy arising new technology of planting container Figure 13 modular modular planting container planting container solution innovation and invention results, As new forms of modular laying ground plane method of planting vessels.



Figure 10. plastics chemical material

Three Segmentation

E L E M E N T	Upper The old elements	Legacy Building	Legacy Sprinkler	Legacy Waterway water spray	Legacy Water jet	Legacy Automatic water spray	Legacy Manual Water spray	A segmentation	
	The Middle element Transformation Of upper Legacy Thinking Unable to break through	New Building	Hanging Water spray	Water hoses	Additional Sprinkler type Water spray	Flume Water spray	Rod holder Waterways Water spray	Semi automatic Fountain	Divided into two Method
	Breakthrough knowledge New thinking way	As a new element in the Middle, transforming old creative thinking In this section be divided again, forming three segmentation method to generate new thinking						Three Segmentation	
	Generate invention New knowledge elements	Creating new modular planting containers Construction of automatic environmental water supply system for permanent							

Figure 11. Three Segmentation

4. REFERENCES

Modular planting container innovations of the circulatory system, Is a legacy technology of planting container of the circulatory system Such as Figure 9 Unable to reach a modular system consisting of the planting container of this study, (James Lim , 2014) Description, Supplies in hot and cold environmental embrittlement of plastics and exposed to air flow, resulting in material embrittlement natural floating dust scattered over a period of time, Plastics recycling difficult when using on horseback or partially manufactured garments or plastic bags, Finally abandoned the formation of garbage, finally landed the combustion combustion of dust affect land plants supply chain the animal and human food environment.

4.1 New modular planting system solutions

This study three methods of segmentation , and ten kinds of innovations in the removal process, (Vijay Kumar , 2013) , Forming modular planting containers , Figure 11 the segmentation method, In Figure 12, ten new architecture lies in the system, Composition listed in Figure 13 important graphic systems and found that, Description section to Appendix a patent for invention, innovation of modular planting containers, graphics and technology, This study Figure 13 new modular planting system solutions, bring the rain down in planting, the plants and soil to absorb rainwater, Soil when moisture excess rain water recycling system, if the excess water after water landing basement this method is appropriate for the new modular planting container ground flat paving methods, Another modular planting container in a vertical manner the flow of rain fall is the same technique described above, landed the excess water subsurface layer, see invention patent illustration. Invention patent illustration. Invention patent number. Modular planting container 103111373, Date of application 2014-3-27.

Process	The manufacturing process	Production Supply	Manufacturing Core Capacity
	Innovation Modes of supply	Product performance	Demand for core
Financial	Financial processes	Computer network Supply	Business Core competence
	Open mode	Talent management	Ability as the core
Modes of supply	Products Performance Process	Products System Supply	Service core competencies
	Function and appearance	Products Project management	Physical and psychological Core requirements
Delivery Way	Delivery flow	What processes	Direct send Or Send
	Brand Established	The customer experience	Revision Demand

Figure 12. Ten kinds of innovations

4.2 New modular plant containers on the ground using

Creative modular planting container solutions, Technical appendix illustrates important research patent module FIG.1 planting container, 30 Photo 32 Right front inner 30 backs And the Bottom front composed of plants Increased adsorption materials Plants absorb water and growth of machine elements, Pre-planting after the formation of Planting frame body (shape does not limit) can be used to build walls. FIG.5graphics and text, 511Natural movement of the natural movement of the water or through the circulatory system to provide water for irrigation plants, May be back in Figure 50 back plate prevents the water out. Internal technology using low walls, using low walls and fences, Using FIG.1Photo 40Increased technical frame External plants in back 44 positions in 40 increased technical frame (FIG.1, 30 graphic) Can be shared. Laying flat on the ground, Board FIG.1 photo 30, 50Can reach the natural flow water for irrigation and planting effect of planting also allows excess water to seep into the ground and modular planting containers Fig7 water catchments collect rainwater use see Fig13,14,15chart..

Laying flat on the ground as shown in Figure 13, On the way to planting,

planting on the ground below with a proper flow of water catchment areas, rainwater supply modular planting container planting. Creates the flow of rainwater on the middle tier and then again used in planting, creating planting water-supply system of innovation, Sustainability green exterior wall's outer fence and ground environment flat paved, 30, 50, using FIG.1 images, using rain water use, Reduce the artificial irrigation planting, to planting ecological innovations, the invention application to help greening. For future urban built environment and create locally suitable for diversity of cultivated plants, producing quantitative green applications, Change the past, sprayed water and used by the old legacy form figure eight old ground planting container planting containers. This discovery will provide long-term transformation of collected rainwater to the circulatory system of planting green synergy of multiple quantitative, on the urban future quantitative planting greenery will contribute Modular planting container provide increased or decreased in accordance with changes in the composition of demand quantified synergies of green planting system as shown in Figure 13, Figure14 and 15chart.. modular planting container circulation find innovative technology.

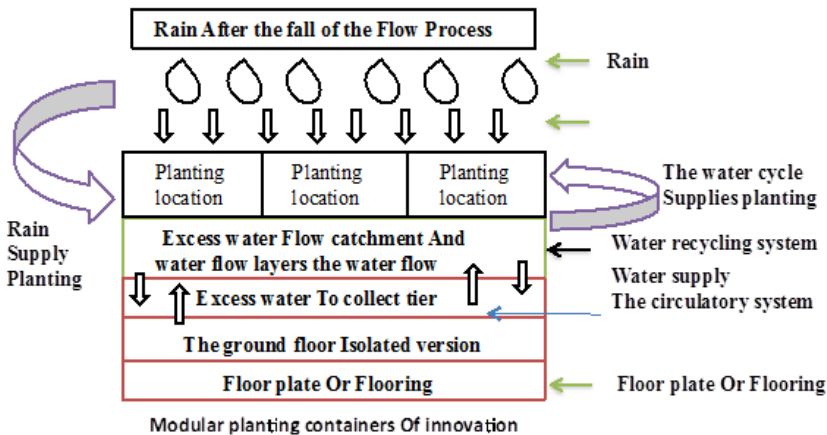

Figure 13. the study on modular planting system solutions

4.3 Invention patents description

Advantages of modular planting containers, of at least one square box, or further, with at least one single-sided square back plate, at least one two-sided square back plate, Can be surrounded in a square box shape of caulk to hold the plant in medium plate boxes by a square box as a channel for plant growth, Can be individually attached by square box used on the walls of buildings and other structures, further insert the square box plates, Or with joined single-sided square back plate, square back plate on both sides of the way into the planting container on one or both sides, Even further to

fight independently on the sodded wall. So as to meet the There could be more changes. (Do not understand, please refe, Modular planting container 103111373,Date of application 2014-3-27). "Designated representative of the case": (14th, 15 modular planting containers chart FG1~9 for patents on behalf of diagram).

4.4 Modular planting container invention patent specification

"Technical field" the invention is related to a plant planted containers, especially one that can meet the needs of more change modular planting containers.

4.5 Advantages of the new modular plant containers

1. The overall modular design, convenient size increase or decrease of the sodded wall.
2. The overall modular design, helps to enhance the structural strength of the sodded wall.
3. The overall modular design, can produce more portfolio changes.
4. Short and perforations of the wall under the action of vegetation made up of water vapour channel is formed between the walls, can be conducted by water vapor permeability of irrigation, effectively reduce the loss of irrigation water.

4.6 Results of the new modular plant containers

1. The overall modular design, convenient size increase or decrease of the sodded wall.
2. The overall modular design, helps to enhance the structural strength of the sodded wall.
3. The overall modular design, can produce more portfolio changes.
4. Short and perforations of the wall under the action of vegetation made up of water vapour channel is formed between the walls, can be conducted by water vapor permeability of irrigation, effectively reduce the loss of irrigation water.

Schema simple instructions 1th as a preferred embodiment of the invention of the appearance chart-related artifacts. 2nd figure as a preferred embodiment of the invention-related artifacts combined state diagram. 3rd map for the use of the invention consisting of sodded wall map. 4th map Line for the invention of the first drawing for construction. 5th map

Structure, there is the second mode of use of the invention section view. 6th map Structure, there is the third use of the invention section view. 7th map for the fourth use drawing for construction of the invention. 8th graph for the fifth use drawing for construction of the invention. 9th drawing another embodiment of the invention of the appearance chart-related artifacts. Modular planting container 103111373, date of application 2014-3-27.

5. CONCLUSIONS

To document two segmentation methods (Zeng Nianmin, 2014), due to lack of innovative detail analysis, again with ten kinds of innovations in the innovation process, (Vijay Kumar, 2013), composed of three new segmentation concept map, separated by three methods in Figure 11 and complete the analysis of innovation processes in the future, Modular plants viable container systems and technology.

Through the modular innovation process systems solve old ground planting container planting containers as shown in Figure 9, Through modular planting containers increases the system can have a long-term effect in Figure 16, Practice and experimenters continue to adopt or amend in the future, As the contribution of research to extend in the future. Reference Figure invention patent Figure 14 and 15.

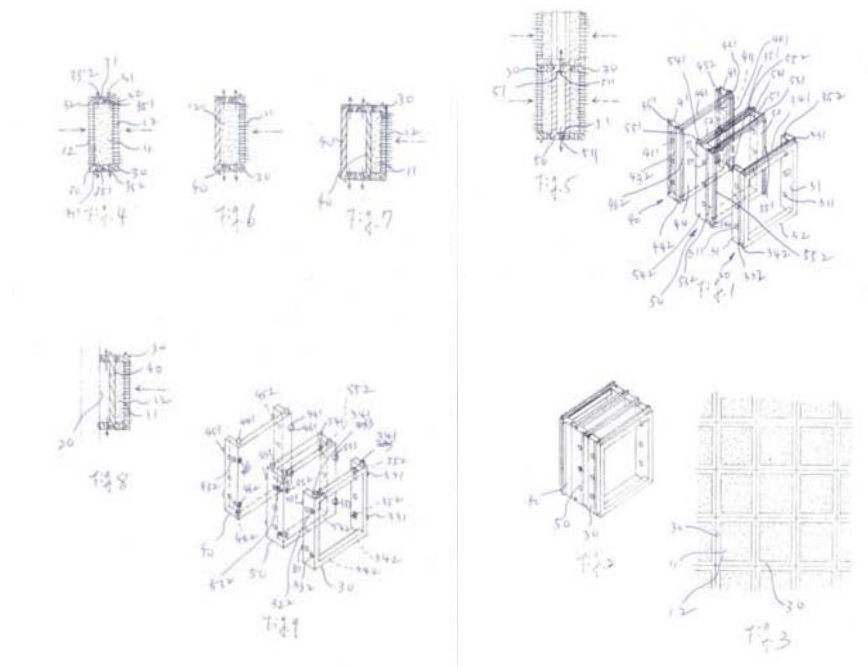

Figure 14. innovation process systems modular planting container (The left Figure)

Figure 15. modular planting containers (Right Figure)

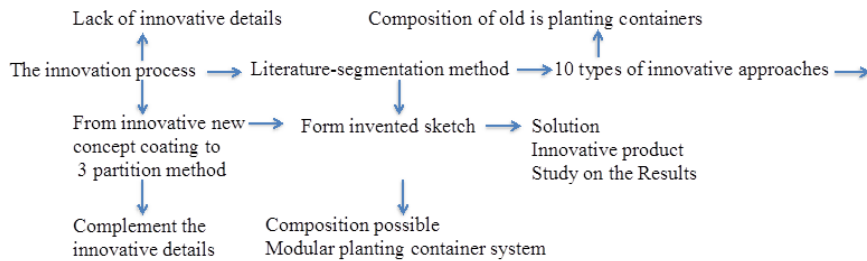

Figure 16. modular innovation process of planting container system

ACKNOWLEDGEMENTS

National Taipei University of Technology. Kuang-Hui, Peng. Dar-Wu, Chen. Zhi-hong Huang Recommendations, Vice President of systems, Yu-shiang Tseng assisting invented by research completed.

REFERENCES

- Ness, Roberta B. (2012). *Problems cannot be solved by thinking within the framework in which the problems were created*. Oxford University Press, Inc. John Maeda with & Becky Bermont. (2012). *Redesigning Leadership*. London, England.
- Xiangyu Wang & Marc Aurel Schnabel. (2009). *Mixed Reality in Architecture, Design And Construction*. Australia Springer Science + Business Media B.V.
- Vijay Kumar . (2013). *101 design methods: a structured approach for driving innovation in you organization*. Chung Asset Management Co., Ltd. Published Taiwan, Taipei.
- Charles Landry . (2013). *The Creative City. A Toolkit for Urban Innovators*. CITE. INC. Taiwan, Taipei.
- Ken-iti Ohmae . (2009). *Thinking technology*. Taiwan, Taipei. CITE INC.
- Tim Brown. (2012). *Change by Design: How Design Thinking Transforms Organizations and Inspires Innovation*. linkingbooks.com.tw. Taiwan, Taipei.
- Jia-hao Zhang. (2007). *Elderly dining utensils Design*. Master's thesis. Department of Industrial Design, National Yunlin University of Science and Technology, Yunlin County.

VISITING SCHOLAR

- Kenichi Sugihara. (2015) . Automatic Generation of 3D Building Models for Sustainable Development, *International review for spatial planning and sustainable development*, Vol.3 No.2 (2015), 68-78

James Lim. (2013). (2014-7-31) .Uniseal Global Pte Ltd. Construction and analysis of practice, YuRegional Department at National Chengchi University. James Lim. (2013). (2014-7-31) .31Manddi Estate Innovation Place IMMEDIA #06-05/06 Singapore 729933.

Ming-Chin Ho. (2013). (2014-12-17) .*Oral Description*. Architecture and Building. Research Institute, Ministry of the Interior. 13F., No.200, Sec. 3, Beisin Rd., Sindian District, New Taipei City 231, Taiwan (R.O.C.)
The Ministry of the Interior Graduate School of architecture Director.

Kuang-Hui , Peng. (2013)..*Oral Description* (2013-11-17) . . Department of Architecture, National Taipei University of Technology.

Zeng Nianmin . (2014). *Oral Description* (2014-1-12). Creative ways of thinking and technology. Appointed by the National Taipei University of Technology Institute of industrial technology. Etsuro Sato.(2014).*Oral Description*.(2014-7-31). Aim Inc.

NO.25

Greenhouse Gas Inventory Accounting for Chinese Cities:

A Preliminary Research

Ruixi Zhao¹ and Yan Li^{1*}

1 Graduate School of Asia Pacific Studies, Ritsumeikan Asia Pacific University

** Corresponding Author, Email: yanli@apu.ac.jp.*

Key words: GHG inventory, Chinese cities, Beijing, GPC, GHG emission

Abstract: City Greenhouse Gas inventory plays an essential role in indicating a city's GHG emissions, assisting urban policy making of emission reduction and providing scientific evidences on analysing mitigation outcomes. With the background that no detailed reports on Chinese cities in applying Global Protocol for Community-Scale Greenhouse Gas emissions inventories (GPC) method have been found and few studies have provided recent GHG emissions on Chinese cities, this research discusses current development of Chinese city GHG inventory and offers proposals for GHG inventory accounting through a case study of Beijing 2011 emissions by using GPC method. The results show that GHG emission of Beijing is relatively high compared with other large cities in the world, and most of GPC method is applicable in China. Further, the study also presents the proposals for Chinese City Inventory building and GPC inventory improvements in terms of unifying activity data sorting scheme between GPC method and city Statistical Yearbook, clarifying boundary principles at international level and domestic level, and enriching statistical data contents.

1. INTRODUCTION

GHG inventory is playing an essential role in mitigation, especially for assisting urban policy making and indicating the reduction outcomes. As President Xi Jinping stated that China aimed to cut down 26%-28% of GHG emissions by 2030, Beijing is attracting a great attention. However, the city inventory and CO₂ emissions are not publicized by Beijing government, and only few of related studies provided comprehensive results on the whole city by implementing international standards.

This study aims to account GHG inventory in Chinese cities through

Beijing study by answering following research questions: How much GHG emissions does Beijing discharged in 2011; Is the international inventory (GPC) able to be applied in Beijing; What implementing experiences can be learned and what improvements can provide to GPC; How to build and design city inventories of metropolitan cities like Beijing.

There are some researchers conducted on Beijing's emissions, for instance, Yuan X.H & Gu C.L.(2011) analysis the availability of implementing ICLEI (Local Governments for Sustainability)'s inventory in Beijing of year 2009 and conclude that the three scopes concept is impossible for Beijing's inventory due to the differences in statistics between Beijing and ICLEI inventory. Further, Shobhakar D (2004) also follows the ICLEI and estimated Beijing emissions, the author pointed out that individual carbon emissions of Beijing was apparently higher than that of Tokyo and Seoul (1990-1998).

In this study, proposals for Beijing's GHG inventory building are going to be provided through calculating 2010 city emissions. It will apply the globally recognized standard of Global Protocol for Community-Scale Greenhouse Gas emissions inventories (GPC). This standard makes the most international organizations (e.g. World Resource Institutions, C40, ICLEI and so on) participate in. currently, there are more than 100 cities having used it to measure their emissions. And according to Wee Kean Fong, Mary Sotos and Stacy Kotorac (2013), it is set to become the first globally accepted framework for city-level GHG inventories.

By following the GPC's calculation standard and its assessment boundary arrangements, the research aims to propose a more systematic calculation of Beijing emissions from three scopes. The Scope 1 is going to cover all GHG emissions from sources located within the boundary of Beijing (like local industry sector's emissions, transportation and waste discharges within the city), and the Scope 2 will include all GHG emissions occurring as a consequence of the use of grid-supplied electricity, heating and/or cooling within Beijing's boundary. Last, the Scope 3 contains all other GHG emissions that occur outside the city boundary as a result of activities within the city's boundary (e.g. products that consumed by Beijing citizens but produced in other cities and waste produced by Beijing citizens but disposed in other cities). The investigation is going to cover six sectors, which are Stationary Energy, Transportation, Waste, Industrial Processes and Product Use (IPPU), Agriculture Forestry and other Land Use (AFOLU), and other indirect emissions. And based on the GPC principles, some sectors are going to cover all of three scopes, while some are only cover one or two scopes.

Regarding to the methodology of calculation, the emissions are basically assessed by activity data multiplying emission factors. For the activity data, it will be mainly collected from Beijing City Statistical Yearbook (for calculating CO₂) and documentary references from Beijing City

Environmental Protection Bureau (for SO₂, N₂O, HFC, PFC, and SF₆ calculating). And the emissions factors are going to follow the ones that provided by GPC's guideline. After that, the research is going to offer analysis on the possibility of GPC's implement and figure out a suitable inventory for Beijing.

The significances of the research can be concluded from both practical and academic aspect. Firstly, through disclosing Beijing's emissions, the study is going to offer recommendations on building a globally compatible and local oriented city inventory. Furthermore, experience on formulating urban GHG evaluation can be promoted and learned by other international cities and Chinese cities that are making efforts in regard to mitigation. Last but not the least, this research is going to provide references for inventory innovation and revolution at city level.

2. LITERATURE REVIEW

2.1 GHG composition and inventory contents

According to Kyoto Protocol, cities shall account for Greenhouse Gas emissions of six kinds of gases including carbon dioxide (CO₂), methane (CH₄), nitrous oxide (N₂O), Hydro Fluoro Carbons (HFCs), Per Fluoro Carbons (PFCs) and Sulphur Hexafluoride (SF₆). In details, HFC contains HFC-23, HFC-32, HFC-125, HFC-134a, HFC-143a, HFC-152a, HFC-227ea, HFC-236fa and HFC-245fa, while CH₄ and C₂F₆ are calculated in terms of PFCs. In 2012, Nitrogen tri Fluoride (NF₃) was added to the second compliance period of the Kyoto Protocol, yet it has not been widely accounted since most of the well-used inventory protocols were released before 2012.

Accounting of those GHG emissions are mainly collected from different sectors and it usually covers 12-month period. As shown in the table below, a case of Japanese city, emissions are accounted from various sectors that include many fields and some sectors cover more than one type of gases. For instance, transportation sector covers emissions of CO₂, CH₄ and N₂O.

Urban activities are contributing to the most emissions. According to UN Habitat, "the proportion of human-induced (or anthropogenic) greenhouse gas (GHG) emissions resulting from cities could be between 40 and 70 per cent, using production-based figures (i.e. figures calculated by adding up GHG emissions from entities located within cities), while it can reach to 60 to 70 per cent if a consumption-based method is used (i.e. figures calculated by adding up GHG emissions resulting from the production of all goods consumed by urban residents, irrespective of the geographic location of the production) (Global Report on Human Settlements 2011 Cities and Climate

Change Policy Direction, 2011)”. Another research even shows that more than 80% of carbon emissions are originated from city (G. Churkina, 2008).

Recently, city inventory is playing an increasingly essential role by the following reasons. Firstly, city inventory provides technological support and references for setting mitigation goals and scenarios for both government and individuals. Besides, it can also assist cities to meet legal and voluntary requirements to report GHG emissions data and assessing emission reduction outcomes. Thirdly, it is a cornerstone for low-carbon city planning and help to improve quality of low-carbon development. Moreover, development of urban level inventory also promotes establishment and perfection of national level inventory schemes. Last but not the least, accounting process and consequences of emission inventory can contribute to city comparison and enhance mutual learning and improvements between domestic cities and international ones.

Table 1- Accounting Contents of GHG Inventory (a case of Japan)

Sectors	Calculated GHG	Fields
Energy Industry	CO2	1. Manufacturing Industry 2. Agriculture, Forestry and 3. Construction & Mining
Residential	CO2	Residential energy consumption
Commercial	CO2	1. Commercial Sewage Waste 2. Finance and Real Estate 3. Public Service 4. Specified Business Operators 5. Individual Services
Industrial Process:	CO2	Cement
Transportation	CO2&CH4&N2O	1. Automobiles(CO2,CH4&N2O) ; 2. Railway(CO2) ; 3. Shipping(CO2) 4. Aviation(CO2)
Waste	CO2&CH4&N2O	1. Municipal Solid Waste 2. Industrial Waste 3. Solid Waste Disposal on Land 4. Organic Waste 5. Water Treatment
Agriculture	CH4&N2O	1. Livestock breeding process 2. Livestock waste 3. Emission from paddy field 4. Burning of crop residue 5. Cultivation of organic soils
HFC, PFC,SF6		1. Household refrigerator

		2. Air conditioners (automobile)
		3. Specified business operators
Forestry	CO2	1. Private Forests
		2. National Forests

2.2 City inventory methodology

Currently, there are a number of GHG accounting methods. For instance, carbon flows, carbon footprint, consumption-based and Direct plus Supply Chain (DPSC). Most of them are concerning with the direct and indirect emissions, and scope concepts. The following Table 2 provides detailed information.

Table 2: Existing GHG accounting methodology 1

Approach	Accounting Method (Contents)	Scope Concept	Application (city)	Functions
Carbon Flow	1.Flow between Urban and External System 2.Flow between different inner sub-system of urban system 3.Flow between Urban and Rural system	Yes	Nanjing (China)	1. Reflect urban efficiency and sustainable development; 2.formulating low-carbon and sustainable energy polices for cities
Carbon Footprint	1.Local production for local consumption; 2.Outboundary production for local consumption (emission occur in outside);	Yes	Dealhi, Manila, London, Seoul, Beijing, Tokyo	1.Figure out consumption users and assigning the responsibility 2.Enable the evaluate of Individual emissions (like each citizen)
Consumption-based	Economic final consumption activity within city*.	No	PAS 2070: London	Relect complex international supply chains and impact of a city beyond its boundaries

DPSC	1.Direct emissions within the city 2.Indirect emissions consumption of grid-supplied electricity, heating and/or cooling, trans boundary travel 3.supply chains from consumption of key goods and services produced outside the city boundary**	Yes	PAS2070: London	Indirect inclusions can assist in the analysis of regional cross-scale and cross-sector infrastructure efficiencies.
Direct Emission2	1.Local production 2. Local consumption	Yes	Kyoto (Japan), Mexico (Brazil) 3GPC:	Data available and consistent with GDP
Direct and Indirect10	1.Local production for Local consumption 2.Local Production for out boundary consumption (emission occur in local) 3.Out boundary production for local consumption (emissions occur in outside) 4.transportation emissions occurred when production (out boundary production and out boundary consumption) being carried	Yes	GPC	Fully reflect GHG drivers and easy for individuals to analyze their carbon activities; provide reference to government on setting mitigation goals

Note:

* All goods consumed by households, government and business capital (goods and services)

** For example: water supply, food, building materials

2.3 Chinese city inventory

China, as one of the largest carbon dioxide emitters in the world (IEA, 2009), is suffering ecological fragility due to the climate change. And she determines to make efforts towards mitigation by a number of evidences such as the goal of cutting down 26%-28% by 2030 (President Xi Jinping, 2014).

Although, no detailed reports of city GHG emission are publicized by the government till now, it has been disclosed by scholars through various methods. And it shows that there is a trend that they are attempting to apply international inventories and make the city emissions comparative at a global level. For example, IPCC methodology is being applied to estimate emissions of Nantong City (Wang P, 2013), and IEAP is being used for accounting Tianjin City's emissions (Deng N, Chen.G.W. et al (2013)). Furthermore, some authors also combined the above two methods and calculated the emission amount of Shanghai City (ZHAO Q., 2011)

However, there are a number of issues, and Chinese city inventory is expected to be improved into a more scientific, more formal and more operable one. For instance, there is no unified city inventory system and the methodology that are being used are incomplete problems like boundary, scope (Cai B.F., 2012), and the relationships between urban and rural areas on inventory system. In summary, the present inventories have various limitations on guiding urban low-carbon development, and the countermeasures are suggested to focus on allocation of GHG emissions, inventory frameworks, inventory borders, and inventory scopes (Bai W.G., Zhuang.G.Y., Zhu S.X, Liu D.R, 2013).

2.4 Beijing City Inventory

The accounting work on Beijing GHG emissions had started from 1994, when China and Canada cooperated on GHG inventory and released the Beijing emissions of year 1991. Though it began early, the development speed is quiet slow (Cai B.F.2012). Over the years, analysis on trends of Beijing discharge amount and the comparisons between other metropolis have increased Zhu.S.L (2009), Brant L., Sidney L. (2010), yet there is a limited number of studies on Beijing's GHG inventory.

Researches on Beijing City GHG emissions can be divided into three categories. The first is accounting city emissions through applying global methodology. For example, Beijing Environmental Protection Bureau adopted IPCC's instruction; however, the carbon emission amount was not released. Meanwhile, some scholars applied ICLEI method and estimated the city emissions. For instance, Yuan X.H, Gu C.L.(2011) calculated the year 2009, yet the outcome fails to meet the statistics of two levels and three scopes in ICLEI due to the differences in statistics between Beijing and ICLEI inventory. Additionally, Shobhakar D (2004) also follows the

ICLEI and estimated Beijing's emissions, the author pointed out that individual carbon emissions of Beijing was apparently higher than that of Tokyo and Seoul (1990-1998).

The second category is accounting city emissions through applying scholars' self-developed city inventories. For example, authors like Zhang M.H., Ge J.P. et al., (2010) established a method that focuses on transforming process of CO₂ biological chemistry through gathering emissions from energy consumption like coal, oil, gas, population physical and soil respiration.

The third category is accounting specific sector of city and offering its relative analysis. For example, Author Li X.Z., Qiu H.H, et al., (2014) provides outcomes of Beijing energy consumption through Input-output modelling. Furthermore, fossil fuel consumption in Beijing was evaluated by the same method by Shan G.A., Ling S. A., et.al (2012). Besides, Benjamin K. S , Marilyn A.B. (2010) announced that the city has a carbon footprint of 1.18 metric tons per person by applying carbon footprint method.

3. BEIJING INVENTORY ACCOUNTING

3.1 Background

Based on analysis of current international city inventory, Global Protocol for Community-Scale Greenhouse Gas Emission (GPC) version 1.0, a collaborative effort between ICLEI, C40 and WRI is going to be applied to accounting Beijing GHG inventory by the following reasons.

Firstly, the GPC the protocol offers an integral and robust inventory framework for Chinese city inventory through providing excel tools and guide in Chinese. Moreover, it proposes instruction of activity data collecting and relative factors, which improves research efficiency and accuracy.

Secondly, the GPC Version 1.0 has a high consistency in approach, methodology and boundary (both geographically and scopes) and enables comparisons between international cities. It contains 6 Greenhouse house gases (e.g. CO₂, CH₄, N₂O, HFC, PFC, SF₆), which are required by Kyoto Protocol. Besides, the consequences of the inventory can be applied for analysis of GHG conditions and mitigation outcomes, which enhances longitudinal mutual learning, specific deficiency altering and low-carbon development quality among cities.

Thirdly, it has a high update speed that provides timely inventory formulation and feedbacks through reliable testing in international metropolis. For example, Version1.0 was released within three months only

after publish of Version 0.9. Moreover, the GPC inventory has been tested within 35 cities globally (2013), which include cosmopolitan cities like Tokyo, London. Therefore, Beijing City’s GHG emission is expected to be determined through the application of GPC method.

Beijing is the capital of China and one of the most populous cities in the world. As the national hub of politics, education and economy, it is located in the northern China (Northern Latitude: 39°28’- 41°95’ ; Longitude : 115°24’-117°30’), with the Warm Temperate Half Moist Climate and surrounded by Hebei Province and neighbouring Tianjin Municipality. Beijing, as a municipality, is directly administrated by the national government and includes 14 urban and suburban districts and 2 rural counties. With the population of 20.69 million people (2012), Beijing becomes the second largest Chinese city by urban population after Shanghai. Contributing to city GHG emissions, Beijing is playing a role of major domestic transportation centre, nation’s industrial centre and one of the largest world trade centres. Furthermore, Beijing serves as a major transportation hub with interstate highways and railways passing through it and a large industrial centre for manufacturing textiles and automobiles. For the study, due to the data limitation, Beijing City emissions are collected from following sectors.

Table 3: Beijing-Inventory Contents Overview

Gases	CO ₂	CH ₄	N ₂ O	HFC	PFC	SF ₆	Scope1	Scope2	Scope3
Stationary Energy	○	○	○	×	×	×	○	○	○
Industrial Process	○	×	×	×	×	×	○	×	×
Waste Management	○	○	○	×	×	×	○	×	×
Agricultural activity	×	○	○	×	×	×	×	×	×
Forestry Activity	○								

Note:

○ : accounted contents.

× : “No”

3.2 GHG inventory

3.2.1 Beijing City Emission 2012 Overview

The study of Beijing inventory covers five sectors based mainly on GPC

methodology. Meanwhile, it also adopts a few foreign methodologies like applied in Japan. And based on the latest available data of year 2012, Beijing GHG emission was accounted with the outcome 776,426,615 tonnes of CO₂ emissions.

Table 4 Beijing City Emission 2012 Overview

Gases	tCO ₂	% of total
Stationary Energy	763,365,763	98.32%
Industrial Process	3,058,127	0.39%
Waste Management	979,457	0.13%
Agricultural activity	2,225,617	0.29%
Forestry Activity	-0.01362	0.00%
Total	776,426,615	

3.2.2 Stationary Energy

According to GPC's instruction for Chinese cities, there are three categories that include fossil fuel combustion, biomass fuel combustion and fugitive emissions due to combustion. However, fugitive emission is not obtainable due to data deficiency.

Regarding the fossil fuel combustion, three scopes are divided. In scope one, emissions from in-boundary emissions from fuel combustion are accounted. It includes sectors like Agriculture, Forestry, Animal Husbandry, Fishery and Water Conservancy; Industry; Construction, Transport, Storage and Post; Wholesale, Retail Trade and Hotel, Restaurants; Residential Consumption and others are calculated as well. In scope 2, grid-supplied electricity consumption from sectors like Agriculture, Forestry, Animal Husbandry, Fishery and Water Conservancy; Industry; Construction; Transport, Storage and Post; Wholesale, Retail Trade and Hotel, Restaurants; Residential Consumption and others are calculated. And about scope 3, energy consumption (e.g. coal, raw coal, cleaned coal, bitumen, petroleum coke, LPG, refinery gas, natural gas, LNG) from Domestic Airplanes refuelling in out boundary, overseas airplanes & ships refuelling in China are calculated.

Regarding the biomass fuel combustion, Crop Straw and Fuel Wood are accounted. Consumption of Wood Charcoal and Animal Waste are also request by GPC, nevertheless data is not available.

The method for calculating emissions is Activity data multiply factor, among which activity data are mainly collected from <Energy Balance

Sheet> from <Beijing Statistical Yearbook 2012> and factors are provided by GPC guideline.

In conclusion, Energy Stationary Sector in Beijing discharged 763,365,763 tCO₂ emissions. It reflects scope concepts and covers CO₂, CH₄ and N₂O emissions. The tables below provides detailed information.

Table 5 Beijing GHG Emissions of Fossil Fuel Combustion

	tCO2	tCH4	tN2O
Scope 1			
Raw Coal	31925399.8	20932.90	505.424
Cleaned Coal	303751.5	3.47	4.991
Briquettes	502515.000	5.61	6.80
Coke	922636.000	91.73	13.760
Coke Oven Gas	306269	6.21	0.621
Blast Furnace Gas	135997.6	0.52	0.052
Other Gas	63795.2	1.29	0.129
Gasoline	12165075	1299.80	107.477
Kerosene	13447412.1	0.168	114.576
Diesel Oil	6689527.2	140.76	55.295
Fuel Oil	461235	11.27	3.651
Naphtha	5090196.556	268.62	80.585
Lubricants	1974506.547	116.41	31.259
Paraffin Waxes	13626.21823	0.72	0.216
White Spirit	8138.102198	0.429	0.129
Bitumen Asphalt	1440767.128	76.03	22.809
Petroleum Coke	782419.0658	0	12.387
LPG	1221794	8627.77726	197.705
Refinery Gas	2479779.6	34.12	3.792
Other Petroleum Products	9071424.6	197.08	75.748
Natural Gas	18897628	370.19	34.026
Tco2 (unit unify)	107903893.2	675887.1895	394143.92
Total (tco2)	108973924.3		
Scope 2			
Electricity consumption (imported from other cities)	102881765.2	1065.837926	1543.21
Total (tCO2)	103382541.4		
Scope 3			
Airplane from Beijing refuelling in out boundary	27052382.11	×	283.93
Airplane from out boundary feruling in Beijing (-)	4666165.59	×	58461.77

Total (tCO ₂)	4351085.42
Three Sopes Total (tco ₂)	216,707,551.1

Table 6 Beijing 2011 GHG emission of Biomass Fuel Combustion

Crop Straw	CH ₄	N ₂ O
Combustion Amount* factor (t)	11722.464	293.0616
tco ₂	246171.744	90849.096
Fuel Wood	2.7	0.08
Combustion Amount* factor (t)	18098984.24	536266.1996
tco ₂	380078669	166242521.9
Total (tCO ₂)	546,658,212	

3.2.3 Industrial Processes and Product Use

GPC requested CO₂ emissions from production of Iron and Steel, production of Cement, and Florien gases (HFC, PFC, SF₆) emissions occurred from producing semiconductor, aluminium production, magnesium production, and electronic devices production. However, due to the data limitation, only Cement is accounted. The data are collected from <Beijing Statistical Yearbook> 11-4, which is <Output of Main Industrial Products in Beijing city>. The calculation method is output multiply the factor.

Table 7 Beijing 2011 GHG emission of IPPU

Item	Production (t)	Factor (tco ₂ /t production)	Emission (Tco ₂)
Cement	568.43t	0.538	3,058,127

3.2.4 Waste Management

There are four categories requested by GPC to report on Waste Management, which are Waste Landfill, Waste Combustion, Domestic Water treatment, Industrial Water Treatment. However, due to the insufficient Solid Waste landfill data (like amount of Food Landfill, Clothes Landfill, and Paper Landfill), only three categories can be accounted.

Table 8 Overview of GPC requested contents

Waste Category	Emission (tCH ₄)	Emission (tCO ₂)	Emission (tN ₂ O)
Waste Incineration and Open Burning		475711	
2.Domestic Water treatment	3880		
3.Industrial Water treatment	696		1315
tCO ₂	96096		407650
Total (tCO ₂)		979,457	

First, regarding to Waste Incineration and Open Burning, Domestic Waste and Hazard Waste are accounted. The data are collected from <City Sanitation Statistic> and Beijing Municipal Environmental Bureau Official Website; here are the Equation and outcomes.

$CO_2 \text{ Emissions} = \sum \text{Amount of Waste Combustion } i \times \text{Rate of Carbon Content in Waste } i \times \text{Rate of Mineral Carbon Content in Carbon Content } i \times \text{Oxidation of Coal during combusting } i \times CO_2\text{-C Rate } (44/12)$

i Stands for different category of Waste: Domestic Waste, Hazardous Waste.

Table 9 Beijing 2011 GHG emission of Waste Incineration and Open Burning

Category	Amount of combustion (t)	Factor (tCO ₂ /t)	Carbon Content in Waste	Mineral Carbon Content	Oxidation of Coal	CO ₂ -C	Emissions tCO ₂
Domestic Waste	6483100	0.27	20%	39%	95%	3.67	475594
Hazard Waste	122000	0.03	1%	90%	97%	3.67	117
Total (tCO ₂)	475,711						

Second, regarding to Domestic Water, it follows the equation : $CH_4 \text{ Emissions Biochemical Oxygen Demand (BOD)} \times \text{Factor} \times \text{Transmission factor (BOD/COD)}$. Since CH 4 Recycle Amount is not available, it is not accounted. Date are collected from <Chinese Statistical Year Book> (2011), and factors are from GPC guideline. Here is the outcome.

Table 10 Beijing 2011 GHG emission of Domestic Water Treatment

COD(t)	TransitionBOD/COD	kgCH ₄ /kgBOD	TCO ₂
87100	0.45	0.099	3880

Regarding to Industrial Waste Water, the equation is: $CH_4 \text{ Emission} = (\text{COD amount of Degradable Organic Matter in Industrial Waste Water} - \text{Amount of Industrial Sludge Treatment}) \times CH_4 \text{ Emission Factor} - CH_4 \text{ Recycle Amount}$. However, Amount of Industrial Sludge Treatment and CH_4 Recycle Amount are not available. The research estimated the emission through following data. Data are collected from <Chinese Statistical Year Book> and <Chinese Environmental Statistical Year Book>.

Table 11 Beijing 2011 GHG emission of Industrial Waste Water Treatment (CH₄ Emissions)

COD amount of Degradable Organic Matter in Industrial Waste Water(t)	BOD/COD Transition	kgCH ₄ /kg BOD	TCH ₄
37491000	0.45	0.04125	696

Regarding to N₂O emissions of Domestic Water and Industrial Waste water, it follows equation: $N_2O \text{ Emission} = \text{Nitrogen Content in waste water} \times \text{Factor} \times N_2O - N \text{ Transition} (44/28)$. Data are from <Chinese Statistical Year Book> and <Chinese Environmental Statistical Year Book>

Table 12 Beijing 2011 GHG emission of Domestic Wastewater and Industrial Waste Water Treatment (N₂O Emissions)

Nitrogen Content N kg	Factor (kgN ₂ O/kgN)	N ₂ O- N Transition (44/28)	tN ₂ O
167506092	0.005	1.57	1315

3.2.5 Agricultural Activity

Beijing Agricultural Activity Emissions concludes CH₄ and N₂O emissions from two sectors, namely, Crop Field and Livestock. The total amount of the sector and detailed information of discharge amount is provided be below.

Table 13 Overview of Beijing 2011 Emissions of AFOLU

Category	Emission (tCH ₄)	Emission (tN ₂ O)
Crop Field		
Waste Crop Combustion	295.27	13.31
Fertilization	×	265.84
Livestock		
Fermentation	718	×

Manure Management	15993.92	5199.5414
Total (tCO ₂)	2,225,617	

Regarding to Waste Crop Combustion, the emissions of waste combustion and fertilization required to be reported. The available activity data are sown area and total Yield (Beijing Statistical Year Book, 2012). However, more data are requested by GPC method, for example N content in Chemical Fertilizer and in Manure. Thus this research applied methodology and factor from Japanese city inventory to indicate the discharge. The method is Total Yield × Residue Rate × Combustion Rate × Factor (tCH₄/t or tN₂O/t).

Table 14 Overview of Beijing 2011 Emissions of Waste Crop Combustion

Item	Total Yield (t)	Residue Rate	Combustion Rate	Factor (tCH ₄ /t)	Emission (tCH ₄)	Factor (tN ₂ O/t)	Emission (tN ₂ O)
Wheat	274383.4	1.3	0.1	0.0025	89.17	0.000038	1.36
Corn	835814.3	1	0.1	0.0024	200.60	0.00014	11.70
Peanut	1302.1	1	0.1	0.0023	0.30	0.00063	0.08
Soybean	8870.5	2.1	0.1	0.0024	4.47	0.000057	0.11
Tubers	12242.6	0.4	0.1	0.0015	0.73	0.00014	0.07
Total					295.27		13.31
tCO ₂					6201.00		4127.00

Regarding fertilization, there are six crops (see below) accounted for the N₂O emissions, it follows the method of area × factor. And the activity data are from <Beijing Statistical Yearbook > while factors are from Japan, as there is no associated factor (tN₂O/ha) that provided by GPC. The details are shown below:

Table 15 Overview of Beijing 2011 Emissions of Fertilizer Application in Beijing

Item	Sown Area (ha)	Factor (tN ₂ O/ha)	Emission
Vegetable	64090.4	0.0021	134.58984
Tree and flower	3412.9	0.022	75.0838
Tuber	2132.6	0.0012	2.55912
Wheat	52183	0.001	52.183

Soybean	4716.3	0.0003	1.41489
Tobacco Leave	3.73	0.0015	0.005595
Total			265.836245
Emission (tCO ₂)			82409.23595

As for livestock fermentation, CH₄ emissions are calculated through the method of which is number × factor. Based on the description of GPC and the availability of the data, four kinds of animals are counted. And the activity data are from <Number of Livestock and Output of Livestock Products> from <Beijing Statistical Yearbook 2012 >, the details are shown below:

Regarding to livestock's Manure Management, emissions are calculated through a complex method, for instance, $N_2O \text{ Emissions} = [\sum_s [\sum_T (N(T) \times Nex(T) \times MS_{(T,(s))})] \times EF_{(s)}] \times 44/28 \times 10^{-3}$.

Table 16 Overview of Beijing 2011 Emissions of Livestock Fermentation

Items	Factors (kg CH ₄ /number)	Number	Emissions tCH ₄
Cattle and Buffalos	80.01111	1873900	149932.8
Sheep	8.133333	25963500	211169.8
Goat	8.333333	414300	345.25
Pork Pig	1	718000	718
Total tCO ₂			7605483

Note:

N₂O = CH₄ emissions in metric tons; S = Manure management system (MMS) ; T = Livestock category ; N(T) = Number of animals for each livestock category Nex(t) = Annual N excretion for livestock category T, kg N per animal per year

MS = Fraction of total annual nitrogen excretion managed in MMS for each livestock category

EF(s) = Emission factor for direct N₂O-N emissions from MMS, kg N₂O-N per kg N in MSS

44/28 = Conversion of N₂O-N emissions to N₂O emissions

And GPC guideline simplifies the factor into emissions of each animal. Therefore, it becomes *number of live stocks × factor* when calculating CH₄ and N₂O. Based on the description and simplified factors provided by GPC and the availability of the data, five kinds of animals are counted. And the activity data are from <Number of Livestock and Output of Livestock Products> from <Beijing Statistical Yearbook 2012 >, the details are shown below:

Table 17 Overview of Beijing 2011 Livestock's Manure Management

Items	Number	Factors kg CH ₄ /numb er	Factors KgN ₂ O/Num ber	Emissions tCH ₄	Emissions tN ₂ O
Cattle and Buffalos	187390 0	5.14	1.32	9631.846	2473.548
Sheep	259635 00	0.15	0.093	3894.525	2414.6055
Goat	414300	0.17	0.093	70.431	38.5299
Chicken	156960 00	0.01	0.007	156.96	109.872
Pork Pig	718000	3.12	0.227	2240.16	162.986
Total				15993.92	5199.5414
Total tCO ₂				335872.36	1611857.83

3.2.6 Forestry Activity and Other Land Use Change

Regarding Forestry and other Land Use Change, emissions from forestry emissions, carbon sinks (forestry carbon absorbing), combustion caused by land use and decomposition are requested. However, due to the data limitation, only forestry activity (macro phanerophytes) could be accounted.

The final outcome of this forestry activity is combination of emissions and carbon sink. Among them, carbon sinks are negative number since it contributes to the absorbing of emissions. Thus the total amount was - 0.01362tCO₂. The method is divided into two. As following shows:

Carbon Sink (tCO₂) = living wood growing stock × Growing rate of living wood × Average Density of wood × Biomass Conversion × Carbon Content × CO₂- C Conversion (44/12)

Carbon Emission (tCO₂) = living wood growing stock × Consumption Rate of living wood × Average Density of wood × Biomass Conversion × Carbon Content × CO₂- C Conversation (44/12)

Table 18 Overview of Beijing 2011 Forestry Activity Algorithm

Stock M3	Growing Rate	Consumption Rate	Average Density t/m ³	Biomass Conversion (All)	Biomass Conversion (Above Land)	Carbon Content	CO ₂ -C Rat e	Carbon Sink tC O ₂	Carbon Emission t CO ₂
29.2	6.39 %	4.31%	0.484	1.771	1.427	0.5	44/12	-0.0418	0.028222
								42	

4. DISCUSSION & CONCLUSION

GPC's methodology covers most of the emissions within cities; however, it also has issues to be solved. Here are the following three examples.

4.1 Data limitation

During Beijing emission accounting through following GPC description, both activity data and emission factor are facing challenges of data limitation. In hence, unifying activity data sorting scheme between GPC method and city Statistical Yearbook and enriching statistical data contents are recommended.

Regarding activity data, there are many defections. For instance, in Industrial Process and Product Use sector, GPC inventory requested production data (like utilization of White Lime and Quick Lime for producing Iron and Steel, consumption of Florien gases (HFC, PFC, SF₆) for semiconductor production and other electronic devices production), however, they are not available for accounting since no available data are provided. Moreover, when accounting emissions from Biomass Combustion, the open burning amount of firewood and animal feces are unavailable. Furthermore, Fugitive emissions from combustion data lack access either. Thus, the emission of Stationary Energy is not complete.

Regarding factor data provided by GPC, it is not comprehensive. For instance, CH₄ emission of railway diesel is requested to be reported in the transport sector, but the factor is not offered. The factor data give causes confusion on calculating. For example, coal combustion does not generate CH₄ emissions, but the generation factor is provided, which discombobulates the authors. Further, GPC factors cannot be used due to the limited published data and foreign methods like Japanese inventory are implemented for this reason. For example, when accounting N₂O emissions of Waste Crop Combustion emission in Agricultural Activity sector, the

only available data are Sown Area and Total Yield while GPC factors can only be applied based on getting Nitrogenous fertilizer consumption amount, so Japanese factor is adopted for getting N₂O emission based on provided data.

4.2 Boundary Issue

In the study, all five sectors cover emissions of scope 1 which is emissions within Beijing. Among them, scope 2 and scope 3 emissions of Stationary Energy Sector are also accounted. Although, scope 3 of Waste Management Sector (includes Waste Landfill, Waste Combustion, Domestic Waste Water Treatment, Industrial Waste Water Treatment) are also requested by GPC to be reported, due to the data limitations of activities that occurred out boundary city (but produced by Beijing) and activities that occurred in Beijing (but produced in out boundary city), the scope can't be accounted.

Boundary issue in terms of indirect emission is one the most intractable issues of city inventory, challenging mitigation policy making of the governments. This study attempts to calculate emissions of other sectors, but not yet achieved due to data deficiency. For instance, in IPPU sector, there is no data about industrial production which is consumed by out boundary citizen but produced within Beijing; In Agricultural Activity sector, there is no export and import data about agricultural production which includes crops and livestock; In Land Use and Change sector, data related to combustion forestry amount (due to land use changing) within and outside Beijing is not available; In transportation sector, intercity passenger transportation and freight data is not provided.

In hence, methodologies like individual inventory and household inventory is proposed for urban emission accounting in order to avoid the previous mentioned issues. And clarifying boundary principles at international level and domestic level are recommended.

4.3 Completeness and Accuracy

Incomplete contents and inappropriate guideline is another issue of GPC city inventory (for Chinese city) in Beijing's case. For example, HFC, PFC and SF₆ emissions discharged from refrigerator and air-condition of each household are not requested by the guidelines. However, the authors believe that it shall be accounted since Florien gases contribute to GHG emission as well. Further, though Energy Balance Sheet is used for Beijing Stationary Energy sector following GPC method, detailed emissions from industry, construction and transportation sectors cannot be counted. Moreover,

method of Animal Waste combustion (Biomass Combustion Department) is Total animal waste (t) * factor (CH₄ & N₂O), however, different animal waste generate different amount of emissions. While in Japan, animal waste are accounted through categorizing various animals instead of using the total number and reached accurate emissions, so the authors recommend Japanese methodology for Animal Waste Combustion accounting to be used instead.

The study provides a preliminary overview of GHG inventory development situation in Chinese cities through a case study of Beijing. In this research, Beijing 2011 GHG emission is illustrated, and it proves that GPC international inventory is applicable in Chinese city. Furthermore, recommendations (like clarifying boundary principles at international level and domestic level, enriching statistical data published by the urban Bureau of Statistic, and unifying data sorting scheme between GPC method and city Statistical Yearbook) are proposed for Chinese City inventory building and GPC inventory improvements.

5. ACKNOWLEDGEMENTS

This work was supported by grants from Japan Society for the Promotion of Science (KAKENHI No.26420634)

REFERENCES

- Bai W.G · Zhuang.G.Y.,et al. (2013). Discussion of Four Issues About Inventorying Urban Greenhouse Gas Emissions in China. *Progressus Inquisitiones De Mutatione Climatis*. Beijing Greenhouse Gases Emission and Abatement Research (1994). *Beijing Municipal Environmental Monitoring Center* ·
- Benjamin K., S. and Marilyn A.B. (2010). twelve metropolitan carbon footprints: A preliminary comparative global assessment. *Energy Policy*. 38 (2010) 4856–4869
- Cai.B.F. (2013). Advance and Review of City Carbon Dioxide Emission Inventory Research. *China Population, Resources and Environment*. 22.
- Cai.B.F. (2013). Research on Greenhouse Gas Emissions Inventory in the Cities of China. *China Population, Resources and Environment*. 22(1). 21-27
- Carbon flow of urban system and its policy implications: The case of Nanjing. Retrieved January 20, 2015, from <http://www.sciencedirect.com/science/article/pii/S1364032114001312>
- Deng N and Chen G.W. et.al (2011). Municipal Greenhouse Gases Inventory and Analysis A Case of Tianjin. *Journal of Tianjin University(Science and Technology)*. 46 (7).
- Environmental Affair office of Oita Prefecture, “GHG inventory for Oita prefecture”, official website, in Japanese. . Retrieved 2015.May from <http://www.pref.oita.jp/10400/advise/bosyu/h17/ondanka/data/shiryou.pdf>
- G. Churkina (2008) Modeling the carbon cycle of urban systems. *Ecol Model*. 216, pp. 107–113

- Global Report on Human Settlements 2011 Cities and Climate Change: Policy Directions.
Retrieved May2015 from
http://www.citiesalliance.org/sites/citiesalliance.org/files/CA_Images/UNH_GRHS2011_CitiesClimateChange.pdf P6
- IEA.(2009).CO2 emissions from fuel combustion 2009-highlights. Retrieved May2015 from
<http://www.iea.org/co2highlights/co2highlights.pdf> .
- Montgomery M R. (2009). The Urban Transformation of the Developing World · *Science*.
319(5864) : 761 — 764 ·
- Shan G., Ling S. et al. (2012). Inventory and input– output analysis of CO2 emissions by
fossil fuel consumption in Beijing 2007. *Ecological Informatics*. 12 . 93–100.
- Shobhakar D. (2004). Urban Energy Use and Greenhouse Gas Emissions in Asian Mega —
Cities . Kitakyushu:
Institute for Global Environmental Strategies
- Wang.P. (2013). Estimation of Greenhouse Gas Emissions for Nantong. *Environmental
Monitoring in
China*.29 (4).147-151
- Xijiping’s Speech reported by Beijing CNN (2014). Retrieved May2015 from Beijing,
CNN. <http://edition.cnn.com/2014/11/12/world/us-china-climate-change-agreement/>
- Yuan X.H and Gu C.L. (2011). “Urban Greenhouse Gas Inventory and Methods in Beijing”,
Urban Environment & Urban Ecology, 24 (1), 5-8
- Zhang M.H., Ge.J.P. et al. (2010). Estimation on Beijing CO2 emissions.
- Zhao Qian (2011). Shanghai GHG Inventory study. *Fudan University Thesis*.
- Zhang. L.X., Hu,Q.H.et.al. (2014) .Input-output modelling for urban energy consumption in
Beijing: Dynamics and Comparison. *Energy Efficiency*. 8(3). 527-543.
- Zhu.S.L. (2009). Present Situation of Greenhouse Gas Emission in Beijing And the
Approach to Its Reduction.*China Soft Science*. 09. 93-106

NO.30

A Preliminary Comparative Study on Subtropical Ecological Community Indicators

Ying-Ming Su^{1*} and Shu-Chen Huang¹

1 National Taipei University of Technology Department of Architecture & Graduate Institute of Architecture and Urban design

** Corresponding Author, Email: ymsu@ntut.edu.tw*

Key words: Eco community , sustainable city , EEWH-EC , subtropical regions , community sustainability assessment

Abstract: Rapid urban sprawl and resource exploitation have led to unprecedented challenges of global environment. An ecological community, which is the integration of architecture, ecology and society, include various aspects such as people, architecture, environment, and overall development. The interdisciplinary integration of ecological cogitation and technology, reflects harmonious coexistence between man and nature, and also becomes a development model for future sustainable settling. In 2011, the ecological community assessment indicators EEWH-EC for subtropical regions were promulgated in Taiwan. In this work, the ecological assessment systems of UK, American, Germany, Japan, Taiwan and China were reviewed. Categories, items, contents, evaluation criteria and weights of these assessment systems are studied and analysed. Results show that the EEWH-EC indicators gave more emphasis on ecology, living and natural environment. The weights of indicators have not developed yet, therefore the degree of importance of each category and item cannot be determined. With the ecological community indicators established by different countries, the social, economic, and humanistic indicators can be strengthened. Reference to international mature eco community indicators formulate, it will be more favourable for the overall development of the ecological community indicators in subtropical regions formulate.

NO.34

Current Situation and Problems of China's Provincial and City Level GHG Inventory

A Literature Review

Hui Qian^{1*}, Qiwen Liu^{1*} and Yan Li^{1*}

1 Graduate School of Aisa Pacific Studies, Ritsumeikan Asia Pacific University

** Corresponding Author, Email: huiqi12@apu.ac.jp ; qiweli12@apu.ac.jp ; yanli@apu.ac.jp*

Key words: Greenhouse gas, emission, inventory, province-level, city-level

Abstract: Nowadays, Greenhouse Gas (GHG) emissions have become a global concern that attracts the attention of governments and scholars worldwide. China is one of the largest emitters, and is now stepping up to the mitigation of emissions from the local levels. Through an extensive literature review, we analyze emissions from 11 cities or provinces in China including Chongqing, Guangzhou, Shenzhen, Nantong, Tianjin, Jiangsu, Xi'an, Anhui, Sichuan, Inner Mongolia and Kunming. We summarize the key features of the present situations; including inventory calculation methods, calculated departments, and calculated gases. Based on these sample cities and provinces, we take an overview of China's current carbon emissions. Then we summarize the shortcomings and inadequacies of the greenhouse gas emission inventory in China from the aspects of calculation methods, calculation departments, and the clean energy usage.

1. INTRODUCTION

1.1 Background

At present, many of the developed countries have carried out various activities related to the Greenhouse Gas (GHG) calculation and emission reductions, for example, London, New York, Toronto, Barcelona, etc. Most of these cities have established the multi-faceted GHG Gas Inventory based on the time sequences and influential factors. Comparatively speaking, the urban-level emission inventory in China has just begun (Cai, 2013; Qin, 2014). The Green House Gas Emission Inventory in China started from the 1990s. In 1996 and 1997, domestic scholars had their initial trial to

calculate the Changjiang Delta with the method provided by the Intergovernmental Panel on Climate Change (IPCC). In 2004, China completed the writing of “National Communication” and reported for the first time about the CO₂ emission in the year of 1994. In 2008, China established the National Greenhouse Gas Inventory for the year 2005. Later, China, for the first time, proposed the city-level Greenhouse Gas study system and its basic rules of calculation in the publication of “City’s Greenhouse Gas Emission Inventory Research” in the year of 2009. As the coming of 2010, the National Development and Reform Commission (NDRC) have formally requested each region to work out their own working plans and to establish method, to properly manage the estimation of the Greenhouse Gas Inventories. Besides, with the progress of rapidly industrializing and urbanization in China, conflicts between the economic development and the consumption of energy are shown. China has to modify its economic development models to the low-carbon development way. At the beginning of the year 2008, the new model of the low-carbon cities have been promoted by the Ministry of Construction (MoC) and the World Wildlife Fund (WWF), Shanghai and Baoding have been designated as the pilot project sites. So far, many provinces and cities have also put forward plans for the construction of low-carbon cities.

1.2 Importance of the research topic

Greenhouse gas emission reduction is one of the main problems that the international society is facing currently. In order to solve this problem, the inventory of greenhouse gas emission is extremely important. China, as the biggest developing country in the world, its total amount of greenhouse gas emission is followed by the United States. So far, at least half of the total carbon emission of developing countries is emitted from China and one seventh of the total carbon emission amount of the whole world is produced from China. The rapid climate change has brought great pressure to the development process of China. Controlling the greenhouse gas emission while ensuring the steady development of economy is the problem that deserves great attention. It is predicted that until the middle of the 21st century, China’s energy consumption will account for more than 60% of the total global energy consumption. Therefore, reasonable reduction of greenhouse gas emission has become the main mission currently. At present, in order to contribute to the overall greenhouse gas emission reduction, many cities’ government and scholars in China have worked on the inventory of GHG emission.

1.3 Purpose of this article

In this article, the authors will introduce and summarize the current calculating situation and problems of GHG emission inventory of provinces and cities in China. Authors have reviewed 11 articles related to greenhouse gas emission inventory of different provinces and cities from academic journals written by Chinese scholars. There are 4 provinces, which are Jiangsu (Chen et al, 2012), Anhui (Fu et al, 2011), Sichuan (Wang et al, 2011), and Inner Mongolia (Yang, 2013) and 7 cities including Chongqing (Yang et al, 2012), Guangzhou (Zhou & Deng, 2013), Shenzhen (Qin et al, 2012), Nantong (Wang, 2013), Tianjin (Shen & Zhang, 2013), Xi'an (Xiangui et al, 2014), and Kunming (He et al, 2013). Based on the understanding of those inventories, the characteristics of inventories and the current calculation problems of China are summarized.

2. CURRENT SITUATION & PROBLEMS OF GHG EMISSION INVENTORY IN CHINA

2.1 International calculation methods

There are four main GHG Gas Inventory approaches applied the most in the world at present, which are direct-emission accounting, carbon footprint accounting, direct-indirect hybrid emission accounting and finally IPCC frame system. The direct-emission accounting means the direct emission of CO₂ in the specific administrative region, which includes the emission of local produced products that are consumed locally, it also includes the emission of local produced products but consumed non-locally. The carbon footprint accounting is the indirect emission, which includes the emission of local produced products that are consumed locally, and the emission of non-locally produced products but consumed locally as well. The direct-indirect hybrid emission includes both the calculating objects of direct-emission accounting and carbon-footprint accounting, as well as part of the emissions from non-locally produced and non-locally consumed products due to their transportation, turnover and storage within the city.

The IPCC frame system is based on the departments, involving various kinds of fuel, the activity level data and the relevant emission factor and other data. The total emission amount is summed up term by term. Japan is one of the leading countries that are doing well in the calculation of GHG emission. The calculation method that Japan is using is referred from the IPCC framework. The calculation is divided by departments, which are Energy Department, Industrial Process, Solvent and Other Product Use, Agriculture, Land-use and forestry and Waste departments. From each main

department, smaller sections are listed and accounted. Main object gases are CO₂, N₂O and CH₄, and 3 other chlorofluorocarbon gases are also calculated during the industrial process. The following graph explains Japan's GHG Inventory in details, which is also a good example for applying IPCC fame system to the implantation of calculation.

GREENHOUSE GAS SOURCE AND SINK CATEGORIES	CO ₂ ⁽¹⁾	CH ₄	N ₂ O	HFCs ⁽²⁾	PFCs ⁽²⁾	SF ₆ ⁽²⁾	Total
	CO ₂ equivalent (Gg)						
Total (Net Emissions)⁽¹⁾	1,222,418.57	22,605.89	23,799.85	13,210.14	6,483.42	4,385.01	1,292,902.88
1. Energy	1,235,264.94	1,285.72	7,942.60				1,244,493.26
A. Fuel Combustion (Sectoral Approach)	1,235,227.42	869.24	7,942.48				1,244,039.14
1. Energy Industries	448,564.29	50.20	2,064.45				450,678.94
2. Manufacturing Industries and Construction	381,040.08	369.24	2,778.45				384,187.77
3. Transport	241,587.08	209.22	2,783.33				244,579.63
4. Other Sectors	164,035.96	240.58	316.25				164,592.80
5. Other	NO	NO	NO				NO
B. Fugitive Emissions from Fuels	37.53	416.48	0.12				454.12
1. Solid Fuels	NE,NO	51.48	NE,NO				51.48
2. Oil and Natural Gas	37.53	365.00	0.12				402.65
2. Industrial Processes	53,729.84	133.81	860.18	13,210.14	6,483.42	4,385.01	78,802.40
A. Mineral Products	50,218.95	NA,NO	NA,NO				50,218.95
B. Chemical Industry	3,298.87	116.51	860.18	NA	NA	NA	4,275.56
C. Metal Production	212.02	17.30	NO	NA,NE	14.69	996.13	1,240.14
D. Other Production	IE						IE
E. Production of Halocarbons and SF ₆				497.61	783.02	1,270.43	2,551.06
F. Consumption of Halocarbons and SF ₆ ⁽²⁾				12,712.54	5,685.71	2,118.45	20,516.69
G. Other	NO	NO	NO	NA,NO	NO	NO	NA,NO
3. Solvent and Other Product Use	NA,NE		244.76				244.76
4. Agriculture		15,271.86	11,274.42				26,546.28
A. Enteric Fermentation		7,120.61					7,120.61
B. Manure Management		2,394.07	4,860.72				7,254.79
C. Rice Cultivation		5,654.25					5,654.25
D. Agricultural Soils ⁽²⁾			NA	6,337.41			6,337.41
E. Prescribed Burning of Savannas			NO	NO			NO
F. Field Burning of Agricultural Residues			102.93	76.29			179.23
G. Other			NO	NO			NO
5. Land Use, Land-Use Change and Forestry⁽¹⁾	-81,362.60	1.91	8.05				-81,362.64
A. Forest Land	-82,867.02	1.91	0.19				-82,864.91
B. Cropland	265.44	NE,NO	7.86				273.30
C. Grassland	-614.90	NE,NO	NE,NO				-614.90
D. Wetlands	167.06	NE,NO	NE,NO				167.06
E. Settlements	848.78	NE,NO	NE,NO				848.78
F. Other Land	607.70	NE,NO	NE,NO				607.70
G. Other	230.34	NA,NE	NA,NE				230.34
6. Waste	14,786.39	5,912.58	3,469.83				24,168.81
A. Solid Waste Disposal on Land	NA,NE,NO	4,516.93					4,516.93
B. Waste-water Handling		1,369.21	1,159.00				2,528.21
C. Waste Incineration	14,226.64	9.31	2,296.09				16,532.54
D. Other	559.75	16.64	14.74				591.13
7. Other (as specified in Summary 1.A)	NA,NO	NA,NO	NA,NO	NA	NA	NA,NO	NA,NO

Figure 1. Japan's GHG Emission Inventory- an example of IPCC's method

Source: National Greenhouse Gas Inventory Report of JAPAN, 2012

2.2 Calculation methods of 11 Cities in China

Among these 11 provinces and cities, 8 have adopted the IPCC Framework, namely, Chongqing, Nantong, Shenzhen, Jiangsu, Guangzhou, Tianjin, Xi'an, and Inner Mongolia. These 8 provinces and cities have calculated the greenhouse gas emission based on the division of the departments. However, Kunming adopts the method of The Carbon Sequestration estimation, Anhui adopts the method of Carbon Footprint, and Sichuan adopts Laspeyres Complete Decomposition Method. Thus, Kunming, Anhui, and Sichuan have not divided into departments for the calculation.

Table 1. Calculation method table of these 11 countries

IPCC Frame System	Chongqing, Nantong, Shenzhen, Jiangsu, Guangzhou, Tianjin, Xi'an, Inner Mongolia
The Carbon Sequestration estimation	Kunming
Carbon Footprint	Anhui
Laspeyres Complete Decomposition Method	Sichuan

2.3 Review of IPCC framework based inventory calculation of Chinese cities

The IPCC Framework, published in 2006, has come up with a systemic explanation and calculation of (1) energy department, (2) industrial processes and product use, (3) agriculture, forestry and other land use, and (4) waste. However, for China, the currently existing GHG emission inventories have not been divided into departments in detail. For example, the transport department and fugitive emission are not included in inventories. The paragraphs below are the summary of the calculated departments for these 8 provinces and cities in details.

Table 1. Summary of the departments that are included in the inventory of each place and the calculated Green House Gas

Chongqing (CO ₂ , N ₂ O, and CH ₄)
The Energy Department (Primary Energy Combustion)
The Industrial Department (Cement Production)
Agricultural Activities (Rice Production and Animal Husbandry)
Waste Department (The life Sewage, life Solid Waste, Industrial Waste Water, Industrial Solid Waste)
Wetland (Natural Wetland and Artificial Wetland)

Nantong (CO ₂ and CH ₄)
<p>The Energy Department (The Burning of Fossil Fuels)</p> <p>The Industrial Department (Cement Production, Steel Production, Glass Production, Ammonia Production)</p> <p>Agricultural Activities (Rice Planting, Animal Digestive Ferment, Animal Feces)</p> <p>Waste Department (Solid Waste, Sewage, Industrial Wastewater)</p>
Shenzhen (CO ₂ , N ₂ O, and CH ₄) Converse the result to the amount of CO ₂
<p>The Energy Department (Electrical Hot Water Production and Supply, the Industry Source, Transportation Departments, Residents' Life, Construction, Business)</p> <p>The Industrial Department (Glass Production, the Ceramic Production, Production of Integrated Circuits, the Application of the Heat Transfer Fluid)</p> <p>Agricultural Activities and Other Land use (Woodland, Farmland, Wetlands, Settlements, Livestock Intestinal Fermentation, Manure Management, Nitrogen Fertilization)</p> <p>Waste Department (Solid Waste Landfill, Incineration, Wastewater Treatment and Discharge)</p>
Jiangsu (CO ₂ , N ₂ O, and CH ₄)
<p>The Energy Department (The Burning of Fossil Fuels, Biomass Burning, Coal Mining, Oil and Gas System Escape)</p> <p>The Industrial and Architecture process (Iron, non-ferrous metal, chemistry industry, construction materials,)</p> <p>Transportation</p> <p>Service industry</p> <p>Residential life</p> <p>Burning fuel of international flight</p>
Guangzhou (CO ₂ , N ₂ O, and CH ₄)
<p>The Energy Department (Agricultural, Industrial, Residential, Commercial and Public sectors, Transportation)</p> <p>The Industrial Producing Process (The Mining Industry, Chemical Industry, Metal Industry)</p> <p>Agriculture (Animal Husbandry, Planting Industry)</p> <p>Land Use Change and Forestry (Urban Green Land Carbon Sink, Urban Forest Carbon Sinks)</p> <p>Waste Management (Solid Waste Disposal, Waste Water Disposal)</p>
Tianjin (CO ₂ , N ₂ O, and CH ₄)
<p>The Energy Department (The Burning of Fossil Fuels, Biomass Burning, Oil and Gas System)</p> <p>Industrial Producing Process (No detailed Introduction)</p> <p>Agriculture (No detailed Introduction)</p>

Waste Management (No detailed Introduction)
Xi'an (CO ₂ , N ₂ O, and CH ₄)
The Energy Department (Fossil Fuel Combustion, Electrical Power)
Industrial Process (Cement Production)
Agriculture (Paddy Fields, Agricultural Land, Animals Intestinal Fermentation and Waste Management)
Forestry and Other Land Use (Forests and Other lignocellulose Biomass)
Waste management Department (Life Industrial Wastewater)
Inner Mongolia (CO ₂ , N ₂ O, and CH ₄)
Energy Activities (Fossil Fuel Combustion, Electric Power)
Industrial Process (Cement Production)
Agriculture (Paddy Field, Farmland, Animal Intestinal Fermentation and Waste Management)
Forestry Activities (Forest and other Substance Carbon Biomass)
Waste Management (Solid Waste, Waste Water)

3. PROBLEMS OF GHG INVENTORIES IN CHINA

3.1 The lack of acknowledged and unified GHG Emission Inventory

Among the 11 articles that authors referenced from, most of the authors adopt the method of IPCC Frame System. However, some authors also use other methods to calculate carbon emission. For example, Fu Jinmu used the method of Carbon Footprint to calculate the greenhouse gas emission in Anhui. He Yunling used the method of Carbon Sequestration estimation to calculate the carbon emission in Kunming, and the carbon balance evaluation model is used to estimate the carbon emission level of Kunming.

Currently, there are a few researches about city carbon emission and low carbon city. However, an acknowledged and unified frame system of greenhouse gas emission inventory is lacked. Key attentions are paid to analyzing the carbon emission of energy; carbon sequestration and total consideration of other greenhouse gas are needed. Besides, most of the researches about greenhouse gas emission adopted the IPCC Frame System and its emission factors. Only a few scholars worked on other methods of greenhouse gas emission. Most researches of scholars are based on their own research goals but not the emission inventory that is certified by government. What is more, each country has its own characteristic; each city also has its own characteristic. Simply applying the method of IPCC Frame System and emission factors is not accurate. High probability of the

inaccuracy could exist. This is not good for the establishing and implementing of specific policies for emission reduction.

3.2 The lack of burning fuel emission data of the cross-border flight and navigation

Among the 11 articles that this paper has reviewed, only the study of Jiangsu Province has claimed that data regarding fuel burning of transnational flight and navigation need to be accounted and aggregated into the final total amount of emission inventory. However, the article concerning Tianjin straightly claimed that No burning fuel data of transnational transportation are accounted. Moreover, the rest of provinces and cities haven't mentioned this field at all.

In general, most of the provinces and cities do not calculate the cross-border fuel burning data of the international flight and navigation. The unclear responsibility of emission belonging is the reason why provinces and cities do not report the statistics related to this issue.

3.3 The limited types of the GHG being calculated

CO₂, N₂O, CH₄, HFC, PFC and SF₆ are the six main Green House Gases that influence the global warming. However, in people's daily life, energy sector produces the most amounts of GHG emissions; more specifically, CO₂, N₂O and CH₄ take the biggest shares of the emission.

Among the 11 articles that this paper has reviewed, 10 of the articles calculate the emission amount of CO₂, N₂O and CH₄, however, Nantong does not calculate the amount of N₂O. It is worth to be mentioned that, in the article about GHG emission study of Shenzhen written by QIN Xiaoling, the authors have converted all the other amount of GHG into the approximate amount of CO₂. With the conversion method and conversion factor introduced by "The Fourth Assessment Report" of IPCC, authors should be able to convert all the other gases to CO₂equivalent.

Since the year 2010, China started to draw up "National Communication", which required the emission amount of CO₂, N₂O, CH₄, HFC, PFC and SF₆. However, analysis of the 3 flon gases is not enough even in the developed countries so far. Detailed method of calculation that provided by the IPCC is not feasible in China due to statistical data availability. Thus, most of the studies conducted by the scholars do not include the 3 flon gases.

3.4 Lack of clean energy usage

Regarding the use of clean energy in China, the studies of the 11 cities show that the usage of natural gas only takes a small percentage, which can be even ignored in some place. The average usage of natural gas in international society is 24 percent. However, natural gas only takes up 5 percent of energy usage in China. In many Chinese cities, the natural gas is barely used. Table 2 shows the energy consumption structure in the 11 provinces and cities that authors have referenced to. The articles of Nantong, Inner Mongolia, and Kunming state clearly that the natural gas is not being used. On the contrary, large amount of fossil fuel especially coal, is the main composition of energy structure. There is no doubt that this condition would cause huge amount of carbon emission. Generally speaking, coal produced a 50 percent more of carbon emission than natural gas for the same unit of consumption. It is worth mentioning that among the energy consumption structure of Sichuan Province, hydroelectric power takes up 7.95 percent. Rational utilization of river power resource and the development of hydroelectric power is a much cleaner way for production and consumption, which should be learnt by other provinces and cities in China.

Table 2. Energy Consumption Structure of the 11 Provinces and Cities

	COAL			NATURALGAS		PETROLEUM						WATER
	raw coal	cleaned coal	hard cokes	liquefied natural gas	natural gas	gasoline	kerosene	diesel	fuel oil	liquefied petroleum gas	other petroleum product	hydropower
Chongqing	75%			14.82%		10.18%						—
Guangzhou	—	—	—	—	—	—	—	—	—	—	—	—
Shenzhen	17.50%	—	—	—	8.20%	19.20%	0.60%	21.10%	30.20%	2.40%	—	—
Nantong	91.55%	1.83%	3.92%	0.02%	0.01%	0.67%	0.02%	0.92%	0.24%	0.54%	0.28%	—
Tianjin	—	—	—	—	—	—	—	—	—	—	—	—
Jiangsu	—	—	—	—	—	—	—	—	—	—	—	—
Xi'an	over 90%			—	—	—	—	—	—	—	—	—
Anhui	From the structure of Carbon Emission Footprint, raw coal has the largest carbon footprint, followed by the crude oil, and the natural gases at the last.											
Sichuan	65.07%			12.68%		14.13%						7.95%
Inner Mongolia	78.76%			0.85%		20.19%						—
Kunming	Burning coal leads the most of consumption, followed by the fuel oil, natural gas is negligible.											

3.5 Lack of reliable data

In term of data collection, the IPCC Framework requires that the level of detail must match the coverage of data, which includes departments/ process/ emission reduction, location, land types, chemical compound, and data from all the years. It means that if the data is collected from a province, the data should be more detailed and the department classification should be more comprehensive than from a city. However, some scholars only calculated one department. We are aware that some of these articles are written based on their academic interests, but not aimed for a complete greenhouse gas emission inventory of a province or a city. Nevertheless, the incomplete inventories reported in the 11 papers reflect the lack of reliable data. In the aspect of environmental policy making, China is urgently in need of establishing GHG emission inventory on provincial and municipal levels. The establishment of appropriate inventory system is good for China to make energy saving policies and measurements to reach the emission reduction goal in due course.

4. CONCLUSION

China, as a fast developing country, the current development process of GHG emission inventory is still facing many problems, such as the differences in calculation methods, the tendency that CO₂ calculation overweighs the other GHG gases, the lack of calculation of flight and navigational fuel, and the differences in calculation duration, data, and scope etc. Besides, the application of clean energy in China is low, suggested by natural gas utilization rate in Chinese cities.

In summary, China's current situation of GHG emission inventory is in lack of consistency, integrity, and authority. With the continuous economic development of China, the calculation system of greenhouse gas emission should be improved accordingly. Furthermore, with the optimization of the industrial structure and energy structure, the development of the clean energy, the expanding of forest and plantation, and the optimization of the treatment of waste will help achieve the goal of greenhouse gas emission reduction.

5. ACKNOWLEDGEMENTS

This work was supported by grants from Japan Society for the Promotion of Science (KAKENHI No.26420634)

REFERENCES

- CAI, B. (2013). Advance and Review of City Carbon Dioxide Emission Inventory Research. *China Population Resources and Environment*, 23(10), 72-80. (In Chinese)
- CHAI, J. (2015, February 28). Fog Investigation of CHAI Jing: Under the Dome. Retrieved March 31, 2015, from <https://www.youtube.com/watch?v=xbK4KeD2ajI>(in Chinese)
- CHEN, Q., ZHU, L., WANG, S., ZHAO, G., & ZUO, Y. (2012).Basic Research on Greenhouse Gas Emissions Inventory in Jiangsu Province. *Environmental Science and Management*, 37(10), 1-4. (In Chinese)
- FU, J., LI, Q., CHU, G., & Chen, X. (2011).Dynamic Change and Factor Decomposition of carbon Footprint of Energy Consumption in Anhui Province. *Journal of Hefei University of Technology*, 34(11), 1726-1730.doi:10.3969/j (In Chinese)
- HE, Y., WU, Z., & XU, R. (2013).Structural Changes and Driving Force of Carbon Sources and Sinks in Kunming City. *Yunnan Geographic Environment Research*, 25(6), 14-21.(In Chinese)
- QIN, X., LU, Q., ZHENG, J., & YIN, S. (2012). Study on Greenhouse Gases Emissions Inventory in Shenzhen City. *Research of Environmental Sciences*, 25(12), 1378-1386.(In Chinese)
- QIN, L. (2014). Legal Strategies Response to the Greenhouse Gas Emission in China.*Economic and Law*, 153-153.(In Chinese)
- SHENG, G., & ZHANG, Y. (2013).Research of the Basic Statistics System of Greenhouse Gas Emission in Tianjin. *Tianjin Science & Technology*, 4, 46-47.(In Chinese)
- Wang, J., MA, G., HU, Y., & Guan, Y. (2011).Research on Carbon Emissions Trend Caused by Energy Consumption and Its Influencing Factors of Sichuan Province. *Water Resources and Power*, 29(7), 185-187. (In Chinese)
- WANG, P. (2013). Estimation of Greenhouse Gas Emissions for Nantong. *Environmental Monitoring in China*, 29(4), 147-151.
- Xiangui, Z., Caihong, M., Ling, X., Gaojian, H., Xiaoyu, W., &Wenlong, C. (2014).Dynamic analysis of greenhouse gas emission and evaluation of the extent of emissions in Xi'an City, China.*ActaEcologicaSinicaActa Eco Sin*, 35(6), 1-12. (In Chinese)
- YANG, J., JU, L., & CHEN, B. (2012).Greenhouse Gas Inventory and Emission Accounting of Chongqing. *China Population Resources and Environment*, 22(3), 63-69. (In Chinese)
- YANG, Z. (2013). The Greenhouse Gas Emission Inventory and Calculation Research of Inner Mongolia. (In Chinese)
- ZHOU, J., & DENG, Y. (2013). The Research of Urban Greenhouse Gas Emission Inventory-----A case Study in Guangzhou. *International Petroleum Technology Conference*, 30-36.(In Chinese)



NO.38

Urban Risk Assessment under Climate Change *The Case Study of Thailand*

Sutee Anantsuksomsri^{1*}, Nij Tontisirin², and Wijitbusaba Marome²

1 Waseda Institute for Advanced Study, Waseda University

2 Faculty of Architecture and Planning, Thammasat University

** Corresponding Author, Email: sutee@aoni.waseda.jp*

Key words: Climate change, urban risk profile, Thailand

Abstract: This research assesses an urban risk profile under climate change using the case study of Udonthani, one of the largest cities in the Northeastern region of Thailand. The study focuses on urbanization process, and socioeconomic and environmental changes of the city. The goal of this study is to analyze current disaster management policies in order to increase preparedness for a flood disaster.

In addition to the economic center of Northeastern region of Thailand, Udonthani is also expected to be the logistic hub of the Greater Mekong Subregion after the regional integration of ASEAN Economic Community (AEC) in 2015. However, there are many challenges that are exemplified by external and internal pressures. The external factors stems from the impacts of climate change which mainly include draught and flood. On the other hand, the internal factors from rapid urban and population growth intensify the impacts of natural disasters.

In order to comprehend the urban dynamic of socioeconomic development of Udonthani under climate change, this study aims to analyze factors that increase the urban risks of floods by examining the socioeconomic and geographic information systems data over the past decade. The urban dynamic factors are categorized into three groups: (1) a hazard profile of flooded areas and durations, (2) a livelihood profile of demographic and neighborhood characteristics, and (3) an economic profile of employment and economic activities.

In Thailand, little has been done on the interdisciplinary study of climate change adaptation. Studies in the past overemphasized on technical mitigation plans for climate change without the aspect of people and adaptation, which is needed to be addressed holistically. This study is a pilot project to study climate change adaptation policies focusing on urban areas in Thailand. The result of this study can be used to formulate robust development strategies as well as regional and urban planning toward resilient societies.

NO.46

Landscape Character Assessment for Area Management of National Territory *Example Study of Kanto-Koshinetsu Region, Japan*

Kyungrock Ye^{1*}, Mamoru Koarai², Takayuki Nakano³ and Yusuke Mizuuchi⁴

1 Chiba university

2 国土交通大学校

3 Geospatial Information Authority of Japan

4 千葉大学大学院

** Corresponding Author, Email: ye.kr92@gmail.com*

Key words: Landscape character assessment , landscape character area ,
geographical characteristics classification , area management

Abstract: Based on current situations that are entered the aging society and declining of economic growth of Japan, we faced the difficulties to manage all the national land resources just by public body. ‘New Public Body’ which means the collaborated power of private and public body to manage their own land resources that can be maintained its own natural and cultural character, are needed.

This study attempted to identify the landscape unit to manage land resources of Kanto Koshinetsu region through to unify the results of Landscape Character Assessment by Ye and Geographical Characteristics Classification by Koarai. Our attempt is to offer the possibility of the Area Management Unit to comprehensive management by new public power. On this paper, we experimentally tried Landscape Character Assessment of Kanto-koushinetsu area in Japan as a land characterization tool for sustainable management. Landform and Land use/Vegetation data has been used to characterize this area on National level characterization. As a result, 16 Landscape types and 110 landscape areas are revealed.



NO.59

Modular Planting Containers of Innovation

Shang-Jen Chen¹, Lih-Yau Song² and Kuang-Hui Peng^{2*}

1 College of Design, Taipei Tech, National Taipei University of Technology

2 Department of Architecture, National Taipei University of Technology

** Corresponding Author, Email: lysong@ntut.edu.tw*

Key words: Design & Green planning, vertical green wall, environmental symbiosis, synergy

Abstract: In order to water plants on the outer walls of buildings, fences, and sidewalks, the old modular sprinkler system is generally used. This system relies on water from either water pipes or underground water. Either way, water is consumed. From the point of view of conserving water, circulating rainwater in an irrigation system could Cities in high density under the influence of architectural space, Forming urban high density of buildings space heating temperature, added to expand building around growing plants, Evapotranspiration of tropical and shading effects can effectively reduce the ambient temperature, thus forming a green demands, the Green and long-term commercialization are more significant, Researchers looked for materials and systems, and related technology based on green wall environment, long-term green building green wall. This study vertical green wall green planting for the long-term effective system solutions from field survey of existing landscaping system Use chemical production materials, Research Method inventions, green wall planting system, The this Method Enhance the future, Green Symbiosis, recycling, environmental protection, landscape, Formed vertical green walls to form symbiotic method five ring planting system. Meaning of symbiosis in the vertical green wall planting system for sustainable green as the goal, In the coexistence of humans and the environment to enhance the role of green space, Water recycling and green buildings and the common prosperity of mankind, Coexistence of man and the greening of buildings, creating green symbiosis, form a innovation of urban greening and environmental synergies. The is green for creative, constitute innovation feasibility, Use pointer In vertical green wall, greening development and urban construction, Long-term symbiotic synergy and green Achieve Renovation and Achieve long-term contributions of vertical Green and Symbiosis.



NO.63

Urban Spatial Strategies for Mitigating Heat Island Effect in Taipei City

Ching-Chuan Lin^{1*}

1 Department of Architecture, National Taipei University of Technology

** Corresponding Author, Email: cclin@mail.ntut.edu.tw*

Key words: Urban heat island, built environment, urban form, spatial strategies

Abstract: This research explores into the spatial strategies for urban heat island effect (HIE) of Taipei City in various dimensions and different categories. The main research question is what the urban heat island characters of Taipei City are, and how to mitigate the heat island intensity of Taipei City from the point view of urban form?

To differentiate the factors and to what extent the factors influenced by typology, climatology, land use, and urban built environment are aims of this research. To understand the formation of HIE, especially, in relation to particular urban area of Taipei, macro, mid, and micro scales are set up for mapping the strategic plan. In other words, regional scale, city scale, and district scale respectively are examined to establish the framework of mitigating HIE of Taipei City. Accordingly, a set of heat island isotherms are monitoring, which indicate in what intensity and pattern the radiation distribute over Taipei City. According to isotherms, the formation of heat island pattern and its related location could therefore be qualitatively assessed. Spatial strategies are put forward to modify the cause of formation in categories: topographic particularities (for examples, terrain, river course, as well as air movements), urban planning, and architecture and landscape disciplines.

Based on comprehensive review of climatology statistics of the past ten years, the HIE of Taipei City could be summarized as followed. First, the prevailing wind of Taipei comes from the north-east, which is almost paralleled along the course way of Kee-lung River all through the year. That is considerably unequal to the prevailing wind directions of Taiwan, with north-east in winter while south-west in summer. Such particular wind direction characteristic is a result of the unique basin terrain of Taipei of which is embraced by rolling hills, with valley to the north-east allows airflow introduces. This character might be critical to heat island effect of Taipei city. Second, the predominantly east-westwards urban structures could also enforce the direction of the most-frequent winds (70°-110°). While the topography and urban form impose influences on HIE, the built environment (building construction, site planning, landscaping) and energy

usage style (transportation mode, air-condition reliance) all considerably attribute to Heat Island Effect of Taipei City.

Strategic plans are developed in various categories and scales in planning and design, for example land use, distribution of building mass, urban volumes and voids, open space structure, natural systems. In addition, studies on urban HIE of Taipei are considerably new area. As an growing city like Taipei, how to transform the built-up areas towards less HIE city to conform to the dramatic social changes, for example, elderly-and-fewer-child-ization society and so on will still be challenging.



NO.71

Abu Dhabi's New Building Typologies *Beyond the Transit City*

Mohamed El Amrousi^{1*}

1 Department of Architecture and Design, Abu Dhabi University

** Corresponding Author, Email: Mohamed.amrousi@adu.ac.ae*

Key words: Abu Dhabi, sustainable architecture, community development, and identity

Abstract: Abu Dhabi through its 2030 Vision is reshaping much of its urban identity creating new forms of architecture that manifest sustainable design and development of new building typologies that aim at retaining its communities and improving the quality of life of its large expatriate community that in the past had conceptualized Abu Dhabi as a transit city. This paradigm shift from its pragmatic urban fabric planned in the 1970's is illustrated by the new forms of architecture and urban spaces that are emerging in mega projects that re-contextualize the concept of the brise soleil and advocate environmental design principles. Masdar City, provides a prominent example of how to design better buildings and urban spaces to improve the quality of life. Many of its buildings are planned to generate energy and implement passive cooling effect. Through their orientation and façade treatment they adhere to environmental design principles. This research highlights the emergence of new building typologies that have been affected by Masdar and its dissemination effect of sustainable design in Abu Dhabi.

1. INTRODUCTION

In the past decade Abu Dhabi has begun to invest heavily in mega projects to change much of its urban fabric from a city that was shaped by a grid street urban pattern and concrete block towers planned in the 1970's to a city that is re-branding its image with iconic projects aiming to develop a sustainable community and spaces of belonging for many of its predominately expatriate community. Abu Dhabi's re-branding includes many iconic buildings such as Etihad Towers, Al-Dar Head Quarters, Ferrari World, Masdar City, the New Central Market, Al-Bahr Towers and shorefront developments in Al-Reem island such as the Skybridge towers, in addition the cultural projects in Al-Saadiyat. These projects which have

acclaimed visibility manifest the emergence of Abu Dhabi on the global map especially through advertising its mega cultural projects such as the Desert Louvre by Jean Nouvel, the Abu Dhabi Guggenheim by Frank Gehry, and the forthcoming Zayed National Museum. Such mega projects are indicative of the fact that public construction projects, are likely to remain a key driver of the construction sector and the economy as a whole. (Ponzini, 2011) Associated with these projects is a large expatriate community and services that are all part of the living city.

The Urban Planning Council is taking serious measures towards directing Abu Dhabi towards sustainable design and planning, a vision that is supported by the Abu Dhabi 2030 Master Plan that aims to regularize newly commissioned buildings along the Guidelines of Estidama. Communities residing in Abu Dhabi are beginning to re-plan their life from the perception of living in a transit city to becoming long term residents. This change offers the opportunity to create from Abu Dhabi an example of sustainable city that caters to the needs of future investors and existing residents. This can be achieved through the design of spaces and places where people would want to live and work, and plan futures for their families. From an architectural sustainable design cannot only rely on environmental criteria but also needs to be a catalyst for a good quality of life and good services for all. (McDonald et al, 2009) Such spaces are beginning to emerge in Abu Dhabi's newly planned shorefront communities such as Al-Raha beach, Yas Island and Saadiyat Island, all of which have either directly or indirectly been influenced by Masdar City which has since its initiation in 2006 has become one of the important contributors to community development, since it represents a real live-scale urban model that exhibiting the latest technologies on its façade skins, which vary from energy producing skins and diverse patterns of perforated screens and louvers. (Figure 1) Masdar is accessible to all and has investments in the area of renewable energy production visible in its solar farm on site, roofs covered by photo-voltaic cells in addition to an offshore wind farm. These attributes contribute to communal awareness in the shift in Abu Dhabi's policy from architecture of a transit city to one of sustainability and community development. As the Capital of the UAE Abu Dhabi has set a 7% clean energy target that will support investments in iconic environmental based projects over the coming years similar to Masdar. According to company officials current investment in Masdar's renewable Energy fields will benefit Abu Dhabi greatly in the medium and long term. The Shams solar power plant is a good example in this direction. (Oxford Business Group 2013: 119)

The Abu Dhabi 2030 Vision and Estidama presents an attempt change the city image through regulations for more sustainable designs in Abu Dhabi. New proposals for a new zero-carbon city, Masdar City, master-planned by the prestigious British architecture firm Foster and Partners,

while still under construction, created an urban enclave that assumes the role of urban laboratory for sustainable design where technology and real live buildings co-evolve to attract significant amounts of attention and visitors as exhibitors of building typologies to be replicable in the living city. Masdar city, despite its incompleteness has provided a prominent example of how to design better buildings and urban spaces to improve the quality of life through sustainable design. Environmentally based architecture in Abu Dhabi depend on an investigation of its surrounding physical context, as it is difficult for architects and planners to balance, especially in oil rich states between the much needed iconic architecture contemporary/modern cities in the Gulf and sustainable architecture that can provide a social hub for the city's diversified community. (Froben, 2006) Such new bipolar paradigms need to cater to multi-cultural community in terms of public and private spatial design and building typologies as a source of community development. (Abdel-Hadi, 2012) This was not evident in Abu Dhabi of the 1980's but is becoming more and more visible in Abu Dhabi in the last decade when designers began to advocate the importance of sustainability as part of the living city. The whole process of shorefront development in Abu Dhabi in Al-Reem, Al-Saadiyat Yas Islands and Al-Raha Beach in addition to the urban sprawl towards the hinterland such as Khalifa City and Mohammed bin Zayed city form new attractions for construction companies to deliver new technologies, supported by state wealth which has become an integrant part of the development and the need to brand Abu Dhabi as a city that is heading steadily towards cultural and environmental sustainable urbanism. The resulting enhancements in design, in turn offer new opportunities for applied research and stimulate new investments as the urban environment once again becomes full of life and enterprise. (Rapoport, 2014)



Figure 1. Façade of Siemens Building in Masdar City

2. MASDAR, REVISITING THE MASHRABIYA SCREEN

In Abu Dhabi many projects seek to incorporate similar strategies to those stated in its 2030 plan and outlined by Estidama for achieving genuine architectural experiences designed by environmental criteria. Projects that take into consideration Abu Dhabi's climatic and cultural environment play a major role in reshaping the living city, such as Al-Bahr Towers with their mechanical shading devices, and Al-Raha Beach residences that exhibit screens and brise soleil in different forms, and even the new Abu Dhabi Judicial Department on al Khaleej al Arabi Street, a complex that despite its municipal function visually communicates the importance of environmental designs in public and private buildings. Abu Dhabi through its 2030 Vision represents an actual implementation that is being felt by its residents in over the past decade as an example of urban development that promotes the identity of a modern Arab city, with socio-cultural and environmental designs that have attributes of contemporaneity with an awareness of the need for multi-ethnic identity. (Mengusoglu & Boyacioglu, 2013) This is evident in the manner in which new spaces such as the Yas Marina and other shorefront developments exhibit methods of sustainable architectural practices that shape spaces of gathering and express a collective conscious of the presence of a multi-ethnic/expatriate community. (Chiotinis, 2006) In addition to its cultural developments and mega cultural projects in Al-Saadiyat, Abu Dhabi's interest in sustainability

is visible via new projects that are emerging within the city. This research highlights the emergence of new building typologies that have been affected by Masdar and its dissemination effect of sustainable design in Abu Dhabi.

Masdar City can be viewed as a regional trend to experiment with sustainable living mediums in Abu Dhabi, an attempt to create a live urban model that is to act as communal educational space to provoke responsibility towards the environment. Many of its buildings were planned to achieve a passive cooling effect through their urban formations in addition to architectural elements that adhere to environmental design such the use of 'corridor facades', double glazing and *brise soleil*, all of which better familiarize architecture to its surrounding context. There are also contemporary reinterpretations of tradition that aim to balance between modernist ideologies that spread widely in the 1950s and 60s based on the architectural design principles of Le Corbusier and regionalists such as the works of Luis Kahn and Charles Correa which aimed to balance modernity and tradition, and create trends in architecture and that would reduce the load on mechanical cooling systems. The reinterpretation of traditional spaces such as shaded courtyards, narrow pedestrian streets and buildings that are cantilevered or raised on columns (Figure 2) offer a fundamentally different spatial context than that in cities such as Dubai, a city that is building around freeways, offering little consideration to its surrounding environmental context. Here an attempt to exemplify a new spatial-social ambience, through the introduction of a new architectural vocabulary that is elaborate tectonically advanced, utilizes the latest materials, yet revisits passive cooling built environments created in traditional medina's in the Middle East and North Africa region. Masdar's designers-Foster and Partners manifest awareness of the main principles on sustainable construction defined by the World Organization for Economic Cooperation and Development (OECD) such as the efficient use of energy, reduction in Co2 emissions and pollution prevention; outdoor and indoor air quality and attempts to create a harmonious environment that is pedestrian friendly in a rapidly developing region. (Li et al, 2014). Here these elements are conceived as separate modules and can be combined, regulated and even articulated. Technically, the new facades exhibited in Masdar City can have dual functions such as the ability to generate clean energy and regulate the amount daylight and avoid glare.



Figure 2. Contemporary screens Masdar City

The diverse patterns of its screens highlight the idea of creating an Arab identity through a morphogenetic process that use digitization in the creation of patterns and highlight a new era that is moving beyond the tradition, linking neo Islamic architecture, still in its formative stages to Arab/Islamic lineages beyond the constraints of regionalism. (Figure 2) In the city much of its buildings are raised above the ground created air channels and cross ventilation through formations of courtyards and stack ventilation. (Pedrao, 1996) The range of variation in patterns displays a diversity of features and juxtaposition of contemporary architecture with attempts to validate modernism as a contributor to sustainable design on both cultural and environmental venues. (Taylor, 2009) In this respect Masdar itself can be seen as a living laboratory and experimental project which not only grows but also inspires the use of future technologies. (Cugurullo, 2013)

3. BRISE SOLEIL WITHIN A CONTEMPORARY CONTEXT

The main difference between Masdar City and earlier antecedents that addressed environmental design is that Masdar advocates itself as a center for innovation in renewable energy and clean energy production. Early examples in downtown Abu Dhabi that date to the 1980's represent the usage of louvers and screens--*brise soleil* using static concrete forms as shading devices. Modernist architects such as Le Corbusier promoted such

forms in the *Unité d'habitation* in Marseille in the 1950's. Le Corbusier's *brise-soleil* and its variations, had the same characteristic of regulating the natural climatic resources wind and sunlight – yet new generations offer the same effect without obstructing the view to the outside from the inside of the building, i.e. the fundamental differences between the earlier generation of *brise soleil* and the new ones, is namely technical. This is especially visible in the twofour54 Abu Dhabi media zone there is strong reference to Le Corbusier's architectural vocabulary such as the use of vertical and horizontal louvers and raising part of the ground floor of the building to create a shaded continuity of the landscape. A representation of experimentation with new materials in the living city in order to advocate the environmental design beyond the realm of Masdar which represents a prominent example of an eco-city. Here the Rotana Part Complex expands the context of sustainability to the tourism and hospitality developments that is visited for its function as a Hotel not as an urban museum or institute/for educational purposes. These attempts to design a living building with solar passive design is viewed as a ripple effect of Le Corbusier's essential elements of architecture, readdressed in the Abu Dhabi 2030 Vision within contemporary contexts such as the necessity of shaded corridors and landscaping. Added to them are traditional elements of regional traditions pathways and open courtyards and the use of water elements. elements such as the used of water bodies as cooling grounds on which air passes before coming in contact with the building facades. A representation of experimentation with new materials in the living city in order to advocate the environmental design beyond the realm of Masdar which represents a prominent example of an eco-city. (Figure 3) Here the manner in which architecture and space intertwine represents how mega projects in Abu Dhabi shape the collective conscious of communities qualifying and promoting certain buildings as “sustainable” (Chiotinis, 2006) The project utilizes extensively and diversely the *brise soleil* and in different forms shapes and patterns as a manifestation a realization of the Abu Dhabi's ambitious programs of developing the community and the city towards sustainable designs. . (Figure 4)



Figure 3. Masdar: Shaded pedestrian, Green corridors



Figure 4. Rotana Park offices building occupied by twofour54



Figure 5. Abu Dhabi New Central Market roof garden by Norman Foster

Abu Dhabi's new Central market designed by Foster + Partners represents a project that connects heritage and modernity in an attempt to transform a vital part of the city center into a reinterpretation of an Arab Souq with cafes, a bazaar and modern shops. As one of the oldest sites in the city the new project was to reinterpret the traditional market place and social space for Abu Dhabi. The project opened in 2011 comprised a combination of high end boutiques, cafes, and roof gardens – forming a new public space for Abu Dhabi. In the Central Market passive design takes into consideration building orientation and layout to reduce the absorption of heat from the sun, enhance inflow of daylight, provision of sun shading devices and wall greenery. The choice of materials was based on thermal resistance and their environmental and energy cost over the life cycle of the building. (Aliagha et al, 2015) The Abu Dhabi Central Market screens included designs were organized according to the rules of regular geometry, and the relatively ambiguous term arabesque. Here the use of the *brise-soleil* produces an immediate visual impact. It follows the norms of the new architecture at the same time that it is able to form a new vocabulary in the city landscape. Their patterns were organized according to rectilinear grids, in which derivatives play a prominent role. (Al-Asad, 1994) The covered Central Market explored the development of a variety of forms, and act as an interface between exterior and interior, instead of being an element of separation, the *brise-soleil* works as an element of transition. Especially in the case of tall institutional buildings, which would be expected to have an absolutely independent life from the streets, they were able to create an ambience of exchange without affecting their common use. (Pedaro, 1996) Le Corbusier's designs offered many forms of designs for the *brise soleil*, they all shared one aim which is to regulate

sunlight at the same time that it allowed a soft ventilation into the building. Today the strong emphasis on environmental based design are criticized for their limitation in terms of public acceptance because of inadequate interpretation of local lifestyles and standards of living, thereby ending up being impractical or inaccessible to the vast majority of the society. (Rapoport, 2014) In the case of the Central market the extensive use of the *brise soleil* represents the inevitable necessity adhere to global changes in the realm of architecture to produce new forms. (Figure 5) In the Central Market attempts to design for the environment cannot fully solve the changes in the modern city resulting from globalization, however, they are attempts to adopt modern versions of traditional forms and patterns as a structure of ornament that can act as a vocabulary for sustainable in rapidly urbanizing Arab cities. (Stegall, 2006) The interplay of light, shade and shadow seen on the interior walls of the Central market are part of the pattern formation of the building skin of the building. The new Central Market on the other hand located several of its cafes either under the shade of its retreating colonnaded façade, in its multiple height atrium or on its landscaped roof. Here community development towards sustainable design is done in an indirect manner while the emphasis is on contemporary architectural translations of cultural meaning and sense into what in many other places have developed into secular institutions of the spectacle—the mall. However, its contemporary screens used extensively internally and externally have also been critiqued as interpretations of the past that have lost the proportions of ornaments developed overtime, thereby resulting in buildings whose façades appear either too big or too small for their buildings. (Schumacher, 2010) Given the complexity and scale of these projects, here lived space is reconstructed as a means of establishing and consolidating place identity in a post-modern, multi-ethnic and multi-cultural society. The combination of the spatial reproduction and environmentally oriented urbanism create a new image of conventional space in the city towards one that goes beyond the context of the transit city to emphasize the importance of socio-cultural cohesion and sustainable communities.

4. THE SHIFT TOWARDS MECHANIZATION

Abu Dhabi's aims to distinguish from other emerging Gulf state cities through its designs that have an emphasis on community development through merging sustainable design and the modern city. This is evident in the location and use of iconic double skin façades that respond dynamically to varying ambient conditions, in Al-Bahr Towers, here using screens on a massive scale as a form of responsive design to the daylight effect is manifested. The two cylindrical towers represent a breakthrough in

sustainable design in Abu Dhabi in that they were designed to exemplify the possibility of constructing a neo-Islamic identity in the form of mechanized triangulated forms that reenact the designs of Jean Nouvel in the *Institut du Monde Arabe* in Paris designed in 1987. While the design of the *Institute du Monde Arabe* was challenged by mechanically failing to automatically respond to the environment it still represented an innovative beyond the traditional *mashrabiya* screens in terms of materials and scale of application. In Al-Bahr towers the same challenges are faced in that not all elements responded to sunrays due to the scale of the mechanized hexeract patterns that constitute a massive vertical building skin that covers two facades of the buildings. (Figure 6) In Al-Bahr Towers each triangle is coated with fiberglass and programmed to respond to the movement of the sun as a way to reduce solar gain and glare. Here the building skin is designed as a responsive elastic architectural skin assembled by series of elastic tetrahedral modules. It contracts and expands without mechanical components such as motors or pistons. It is a kinetic tent-like skin which changes shape to meet various needs and environmental conditions, supported by a complicated mechanical system as well as manual control mechanisms. (Khoo, et al 2011) The purpose of making such a complex system combines good attributes of the two principles (mechanical and natural) to ensure both good air quality and thermal comfort. (Dahl, 2010) Similar to the *Institut du Monde Arabe* a new identity for high-rise towers in Abu Dhabi has been created, a design that reinforces State interest to advocate sustainable designs that are not frozen in time and constrained by attempts to authentically reproduce traditional forms. The triangulated patterns of the Burj Al-Bahr reflect the possibilities of application of the environmental designs that are stipulated by Estidama, in a living city and within contemporary time and space that manifests the dynamic nature of architectural design. The vertical application of the responsive hexeract elements that open and close are made visible by the location of the towers on Al-Salam street, one of the main arteries from Abu Dhabi Island to its hinterland. The mere discussion as a result of the visibility of the towers triggers communal development and promotes contemporaneity of traditional ornaments that can be integrated onto modern buildings as a fragment, a whole or a collage. (Schumacher, 2010)

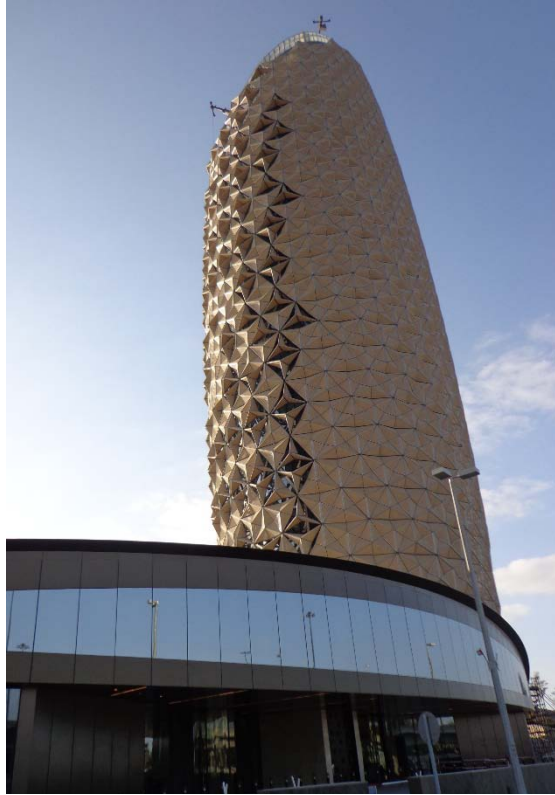

Figure 6. Al-Bahr Towers Abu Dhabi



Figure 7. Al-Raha Beach-Al-Zeina Residences

5. CONCLUSION: SUSTAINABLE DESIGN AND THE LIVING CITY

In Abu Dhabi we are witnessing the ascendancy of a new genealogy of buildings that will change the image of the city, branding and the multiplication of massive structures built with sustainability as design criteria are becoming forms of mediation between the state and community development. Perhaps the most direct insight into the power of Masdar and other environmentally based projects come with the recognition that sustainable design supported by funding from the oil rich state allows such projects to quickly gained great visibility. Masdar City, though still incomplete yet it has set a prominent example of how sustainable design can be applied, its influence is being felt in the living city especially in projects like Al-Raha-Zeina beach residences. (Figure 7) Al-Raha-Zeina beach residences represent a further expansion of the use of environmental design the creation of architecture that caters to the needs of the multi-ethnic community of Abu Dhabi. Today new generations of *brise soleil* are lighter and more flexible, which allows their application within the living city to be represented within a contemporary context as a new form of design to address the hot humid weather and provide shading around the building, in addition it allows the resident community of Abu Dhabi to appreciate its passive cooling environmental treatment. These new forms represent ambitious targets, attractive designs, and the ability of the oil rich state to use innovative technologies, as manifested especially by Hotels and newly emerging iconic designs. Although the aspirations for full scale green cities still have a long way to go, here in Abu Dhabi individual buildings such as the Al-Bahr towers and the new central market represent a new venue for sustainable design in that these buildings which were meant to be viewed and experienced by all, have collectively begun to form a powerful image of sustainable design within an innovative context that represents the degree to which Abu Dhabi's efforts are to supplant its initiative to create a modern city with a vision to emerge on the global map. In the end, Abu Dhabi is probably best understood as simultaneously itself and beyond itself, a desert dream with all the sustaining power implied in that.

REFERENCES

- Abdel-Hadi, A. (2012). "Culture, Quality of life, Globalization and Beyond", *Procedia - Social and Behavioral Sciences*, vol. 50, pp. 11–19. Elsevier-Science direct.
- Al-Asad, M. (1994). "Applications of Geometry". Eds. Frishman & Khan. *The Mosque, History, Architectural Development and Regional Diversity*. Pp. 55-71. (1994) Thames and Hudson, London.

- Aliagha, G., Goh, A., Abdullah, M., Jaafar, N., Eluwa, S. (2015) "Investigating Skill Gaps in Green Building Skills for Energy Efficiency", *Advanced Materials Research Vols. 1073-1076* (2015) pp 1282-1287
- Boake, T. (2002). "The Tectonics of the Double Skin: Hi-tech or Hi-jinx?", ARCC/EAAE International Conference on Architectural Research, Montreal.
- Buhagiar, V. (2006). Sustainable Development and Building Design in Malta. Faculty of Architecture and Civil Engineering, University of Malta, Msida, MSD: 06.
- Chiotinis, N. (2006) "The request of sustainability and architecture as cultural paradigm", *Management of Environmental Quality: An International Journal*, Vol. 17 Iss: 5, pp.593 - 598
- Cugurullo, F. (2013). How to Build a Sandcastle: An Analysis of the Genesis and Development of Masdar City, *Journal of Urban Technology*, 2013 Vol. 20, No. 1, 23–37. Routledge
- Dalu, J. (1978). "Surface Pattern and Light", ed. George Michell, *Architecture of the Islamic world: its history and social meaning*, New York 1978.
- Diane, W., Smith, . (2013). "From Bricks to Bytes: Digitizing Green Cities", *International Journal of Technology*;2013 Special Edition, Vol. 4 Issue 3, p269
- ElDemery, I.M. (2010). "Sustainable Architectural Design: Reviving Traditional Design and Adapting modern Solutions", *Archnet-IJAR, International Journal of Architectural Research*, Volume 4 - Issue 1 - March 2010 - (99-110).
- Elshestawy, Y., (2008) "Cities of Sand and Fog: Abu Dhabi's Global Ambitions", in Y. Elshestawy (ed.), *The Evolving Arab City: tradition, modernity and urban development*, New York: Routledge, pp. 259-299
- Proben, A. (2006). "Socially Sustainable", *The Canadian Architect*, Volume 51, Issue 4, p. 62
- G. Li, Q. Q. Qiao, X. M. Zhou, (2014). "The Engineering Examples of Sustainable Architecture", *Advanced Materials Research*, Vols. 1008-1009, pp. 1310-1315.
- Joss and Molella, (2013). The Eco-City as Urban Technology: Perspectives on Caofeidian International Eco-City (China), *Journal of Urban Technology*, 2013 Vol. 20, No. 1, 115–137. Routledge
- Khoo, C, Salim, F and Pallett, J. (2011). 'Designing architectural morphing skins with elastic modular systems', *International Journal of Architectural Computing*, vol. 9, no. 4, pp. 397-419.
- King, D.A., (2004). *Spaces of global cultures: architecture, urbanism, identity*, New York : Routledge, 2004.
- Sally McDonald, Naglis Malys, Vida Malienė, (2009) *Urban Regeneration for Sustainable Communities a Case Study*. *Baltic Journal on Sustainability*. 15(1): 49–59
- Mengusoglu, N. & Boyacioglu, E. (2013). "Reuse of Industrial Built Heritage for Residential Purposes in Manchester", *METU Journal of the Faculty of Architecture*. (30:1) 117-138
- Oxford Business Group, Abu Dhabi 2013, London: Oxford Business Group, 2013
- Pedrao, A. (1996). "The Use of the Brise-Soleil in Brazilian Modern Architecture" *Docomomo Journal*;1996 Conference Proceedings - 4th C, p183.
- Ponzini, D., (2011) "Large scale development projects and star architecture in the absence of democratic politics: The case of Abu Dhabi, UAE", *Cities*. Vol. 28, pp. 251–259.
- Q. Liu, (2015) "Research on Green Public Building Construction Industry", *Applied Mechanics and Materials*, Vols 716-717, pp. 269-272.
- Rapoport, E. (2014). *Utopian Visions and Real Estate Dreams: The Eco-city Past, Present and Future*, *Geography Compass* 8 (2) (2014): 137–149. Routledge
- Sassen, S. "Urban Capabilities: An Essay on Our Challenges and Differences", *Journal of International. Affairs*. Vol. 65, No2, spring/summer 2012.

Environmental Planning & Green Building

- Schumacher, L.(2010). “Façadism” Returns, or the Advent of the “Duck-orated Shed”
Journal of Architectural Education, pp. 128–137.
- Shwayri, S. (2013). A Model Korean Ubiquitous Eco-City? The Politics of Making Songdo,
Journal of Urban Technology, 2013, Vol. 20, No. 1, 39–55
- Taylor, J. “Shiny, Slick and Sustainable: Abu Dhabi's Masdar City is an experiment in
sustainability built on oil money. But will it work”, Alternatives Journal, Vol. 35, No.5,
2009.
- Tregenza, P. & Wilson, M. (2011), Daylighting, Architecture and Lighting Design,
Routledge.



NO.72

The UAE's Challenging Path to Urban Sustainability *Abu Dhabi Case Study*

Paolo Caratelli^{1*} and Maria Alessandra Misuri¹

1Department of Architecture and Design, Abu Dhabi University

** Corresponding Author, Email: paolo.caratelli@adu.ac.ae*

Key words: Sustainable development, urban sustainability, developing countries, sustainable architectural design, sustainable urban design, Gulf cities

Abstract: The WWF's biannual Living Planet Report compiled for the year 2008, showed an alarming increase of global CO₂ production associated with a rapid depletion of natural resources, including fishery, cropland and grazing as never registered since 1970. Several factors have been considered, both at local and regional scale such as Ecological footprint and Water footprint, in order to assess the impact of human activity on the global ecosystem. The argument was if the current rate of development followed by the global human community, intended as economic and social domain, could be considered sustainable by our living planet in long term. The answer was no. The following biannual reports, until the last published in 2014, reinforced these assumptions, showing an even dull and deteriorating perspective. At current rate of consumption, we need 1.5 Earths to meet the expected demands in term of food, water, and energy security, with unsurprisingly peaks of demand in high-income countries. In other terms, we are demanding more renewable resources and CO₂ sequestration than the planet can provide in an entire solar year, overshooting resource's availability by the ninth month every year since the 1990's.

Since the 1961, the global biocapacity available per person calculated in gha (global hectares), decreased from 3,2 gha to 1,7 gha per capita, due increasing population, changes in economies, and lifestyles.

Among these figures, UAE's Ecological Footprint per capita is the third largest in the world, mainly due its huge carbon footprint, of 8.4 gha despite the country itself has only 0.6 gha of biocapacity available per person. It means that UAE's residents are mainly dependent on the resources imported from other nations to meet their needs in terms of food, goods, and services, with the sole exception of energy, due country's global position as oil producer and exporter. However, this reliance for some categories of goods on external resources only, pose the country to a potential risk of disruption, if such resources could become more constrained in future.

The large availability of fossil fuel reserves and the flow of revenues derived from its extraction and exportation, has shaped the urban aspect of UAE during the latest 20 years as commonly known today, but this model of

Environmental Planning & Green Building

undefined urban growth is already showing defined limits. Assuming the Emirate of Abu Dhabi as case study, it's showing a constant population growth rate of about 7,5% per year since 2005, and an increasing of water and energy demand per year of 2,5% and 3,1% respectively. This growing rate is pushing urban and environmental sustainability under a constant pressure, with foreseeable implications on future resources' availability. Relying on food and goods availability largely outsourced, and on energy derived by hydrocarbons from local sources, UAE's urban settlements are currently embodying a development model that cannot be duplicated or even merely pursued as it is, despite its extraordinary success as economic model for others emerging Gulf cities.

Scope of this paper is to gather attention on the current UAE's urban realm and its future developments, analyzing possible alternative solutions, and applicable sustainable development's models, with aim to contribute to the wider discussion about the phenomenon of growing urbanization worldwide, and how to conjugate this trend with a desirable, and necessary, sustainability.



NO.78

Keys to Renovate B&B Houses to Meet Green Building Standard

Sunny Lee^{1*} and Shuying Tsai^{2*}

1 TGDesign Studio

2 National Taipei University of Technology

** Corresponding Author, Email: service@tgdesign.com.tw ; tsaisshuying0914@gmail.com*

Key words: Evaluate B&B buildings , tourism green buildings design , green B&B building guide

Abstract: Among those requirements on public buildings to meet green building standards, there's few models stand for green buildings in tourism industry. Touring is part of Taiwanese culture for long. More hotels and B&B are opened also due to increasing Chinese tourists. Few research studies suggest renovate ways to meet green building standards. If tourism buildings could be categorized and recommend improving prescriptions, or set incentives and disincentives; should help to save energy and improve ecology environment.

This article will evaluate existing Taiwanese B&B buildings from green building standard perspective, giving suggestions on daily energy saving, sustainable environmental methods, use of green building materials and tourism green buildings design. Observation behaviors, visiting guests and owners, and designing online surveys will be the research methods. Combining data collected from targeted areas to form a diagnosis formula for green B&B.



NO.79

An Analytical Overview of Urban Development Plans in Dubai

A sustainable Development Approach

Seyed Ahmad Reza Yekani Fard^{1*}

1 Islamic Azad University

** Corresponding Author, Email: yekanifard@iau.ae*

Key words: Dubai, urban development plans, sustainable development plans, sustainable development approaches

Abstract: It is a very tough work to talk about The United Arab Emirates Development Plans in a limited time frame works because there is some pro and cons idea about these developments that if we consider sustainability debates in between will be very controversial issues.

United Arab Emirates is situated in South West Asia, bordering the Gulf of Oman and the Persian Gulf, between Oman and Saudi Arabia; From South to North Abu Dhabi the capital of UAE and Dubai the Business and Tourism center of UAE are located. Dubai is a city that is constantly changing due to a very fast urban growth fuelled by its business and tourism-oriented development. Dubai started as a transit commercial port between the Gulf countries, Persia, the Indian sub-continent and East Africa.

As a result, Dubai has started a multi-billion dollar urban development through mega projects' in order to establish itself as a Global business, tourism and leisure destination (Elsheshtawy, Y., 2004:180). It is now expanding its services portfolio by creating numerous Commercial and Residential Developments as mega projects.

The literature indicates that the speed and intensity of change in Dubai in the last two decades triggered several sustainability concerns such as: 1- Fragmentation (Physical and Social), 2- Lack of Connection, 3- Segregation, 4- Erosion of Local Culture, 5- Form and Function of the Landscape, 6- Environmental Deterioration, 7- Regulation and Public Participation which each category of lacks and problems has their own subcategories which will be explained and covered in this paper.

Exactly here is the place that we should decide about stability and sustainability of existing projects and its future and also look forward to the development projects that will be launch and develop in near future as we are expecting and awaiting 2020 Dubai Development plan and Expo 2020, and should be so curious and eager toward them.

In This paper focus will be on different development strategies such as choosing between sprawl and compact city, New Urbanism, Walkability or car dependency, TOD, or non-transit means of transportation, Smart Growth,

Green Building and Urban Metabolism along the focusing on equity, Social Justice and Socio- economic dimensions of sustainability as an integrated proposed model for enhancing Sustainable Urban Development.

At the end the paper is seeking to answer to two main questions as the outcome of the studies; First; what kind of sustainability solution and strategies will be considered regarding the optimum urban form and second; how integration of these Strategies and solutions together could create a holistic and systematic sustainable development approach to work in all the future Urban Development Plans in Dubai and even have the capacity to be generalized and to be applied to another Urban Development plans in UAE as well.

1. RESEARCH FRAMEWORK

1.1 Research Methodology

To answer to the above mentioned research questions, the following research method was applied. The main research strategy in this paper is qualitative research and regarding to the characteristics of our research different approaches of qualitative research is used.

Descriptive study: As a method to analyze and understand different attributes of urban development's projects in Dubai.

Document study and content analysis: As an approach to review different written scientific papers and dissertation on Dubai urban Development to find out advantages and disadvantages of Critical opinions.

Field study: In order to observe, compare and evaluate actual deficiencies, lacks and mal functions in Dubai urban Projects in terms of an empirical study.

Qualitative Evaluation: As a means of finding the best solution, and strategies based on different intervention strategies in developments and choosing the best solutions among them.

1.2 Research Objectives

In this research achieving the following objectives is planned.

- Introducing an analytical study about urban development projects in Dubai,
- Pathology and diagnosis of likely mal functions and disadvantages of existing urban development's projects,
- Introducing a model of urban development to be sustainable,
- Providing an integrated and comprehensive Urban development model which could be applied in another urban development plans in UAE

2. DUBAI; A GEOGRAPHICAL OVERVIEW

The United Arab Emirates is situated in South West Asia, bordering the Gulf of Oman and the Persian Gulf, between Oman and Saudi Arabia; it is in a strategic location along northern approaches to the Strait of Hormouz, a vital transit point for world crude oil.

Dubai is the second largest Emirate after Abu-Dhabi in Second place and could be named as the Business and Tourism Capital of UAE.

The origins of the modern city of Dubai are rooted in the tribal culture and political history of the region. In the eighteenth century, the southern part of Trucial Oman, now the territories of Dubai and Abu Dhabi), was occupied by the Bani Yas tribe while their historic rivals the Qawasi (The Qawāsim, the ruling dynasty of Al-Shāriqah, were the principal leaders of the Persian Gulf pirates from the early 18th century; from their bases at Al-Shāriqah city and, more particularly, Ras al-Khaymah town, they raided shipping of all flags with impunity and even threatened Bushier (Būshehr), then Britain's main... controlled the area north of Dubai, (now the emirates of Sharjah and Ras al Khaimah). The period was marked by a struggle for maritime supremacy of the Gulf between the two tribes.

A political change of fundamental importance for the growth of Dubai occurred in 1833 when a group of around 800 members of the Al BuFalasah subsection of the Bani Yas tribe seceded from Abu Dhabi following a dispute with the ruler and moved to form an independent sheikhdom in Dubai.

on 1st December 1971 a new political entity of the United Arab Emirates came into existence, comprising the former sheikhdoms of Dubai, Abu Dhabi, Sharjah, Ajman, Umm al Qairain, Ras al Khaimah and Fujairah.

2.1 Dubai of the Nineteenth and twentieth Century

The Al-Maktoum dynasty was established in Dubai in 1836, with the associate Monarchical intrigues of loyalty, lineage and succession. The second half of the nineteenth century proved to be more prosperous For the lower Gulf region, particularly for the pearling sector run by the merchants. The maritime truce offered a calmer environment for pearling, and the increased Business demonstrated how the sector benefited from this.

During the 1920s, an increasing trade with Persia attracted merchants to Dubai, some

Of which decided to settle down after that Dubai ruler invited them to do so with their families (Heard-Bey, F.: 244-245). During the 1950s, Dubai started to improve its creek due to the discovery of oil and increased activity in exploration, which required the import of large and heavy equipment. Dubai continued to grow and develop by widening its roads and

hiring British town planners to produce urban growth plans. By 1961, an airstrip was built and was taking planes. Two year later the building of the airport begun immigration.

Dubai airport begun and the runway was complete in June 1965. The 1960s and 1970s saw more large-scale developments including the building of port infrastructure. Population growth continued and Dubai reached an estimated 120,000 inhabitants by 1973, and over 250,000 by 1981 mainly due to immigration. As a result, the population boom required considerable investments in public facilities and infrastructure. Dubai started its metamorphosis, as modern multi-story buildings appeared, the construction of a road tunnel under the creek, bridges over the creek, and reclaimed land.

Dubai's future was to be based on manufacturing industries, re-export, trade and services, which lead to the creation of Jebel Ali industrial Centre and the expansion of Dubai airport to allow for cargo shipment. (Heard-Bey, F.: 263-264).

During the 1980s and 1990s, Dubai started to strengthen and improve its tourism facilities. It is

Estimated that about 6.7 million tourists have visited the city last year, and over 15 million passengers have used Dubai airport in 2004. Dubai aims to increase its tourists' number to 12 million by 2010 (Sher, A., 2005).

As a result, Dubai has started a multi-billion dollar urban development through mega projects' in order to establish itself as a Global business, tourism and leisure destination (ElSheshtawy, Y., 2004:180). It is now expanding its services portfolio by creating 'cities' such as Health care city, Academic city, Silicon Oasis, and International city, added to the already established Media city, Internet city, Dubai International Financial Centre, and Knowledge Village. At the same time, it is creating residential communities to support these mega projects.

2.2 Spatial distribution of development Projects in Dubai

In the globalization era, the city planned for new financial, commercial, entertainment, governmental, and residential centers through a series of mega projects controlled by public-private partnership that brought investors through all over the world. Perhaps, the first action toward globalization was building a contemporary downtown area. The corridor along Sheikh Zayed highway towards Jebel-Ali dubbed Dubai as a modern city. Spectacular amount of projects were built alongside this stretch of highway resulting in shifting the city's skyline, image, and center (Elsheshtawy, 2004).

Since the 1990s Dubai has experienced extraordinary development. Massive projects were frequently declared; each apparently planned to

surpass the previous and even concurrent ones. One spectator noted that —mappers in Dubai must be constantly frustrated. No sooner have they finished their latest in-depth representation of the city when another major project is announced to send them scuttling back to the drawing board (Smalley, 2002). Mega projects like the tallest skyscraper in the world and several man-made islands were partly based in the recognition that oil is drying up; therefore, the city had to establish a new economic by embodying a universal hub for leisure, trade, and services. But many observers trace the early start of Dubai's trade activity before the explosion of wealth brought by oil discovery in the late 1960s. Historically, the city was based on trade and commercial activities such as pearl industry, accommodating several merchants from India, Pakistan, and Persia. The idea of being a commercial hub is not something new to Dubai; it is indeed a part of its long history. But the aspiration for being a regional and global commercial and business hub has evolved in scale, capital, and strategy.

Using its transitory oil wealth, the emirate has built —free zone areas, clusters defined by economic liberalization, technological innovation, and political transparency. Davis (2007) said that although tourism projects generated most of the —buzz about Dubai, the city attempted to add value to its growth through a series of specialized free-trade zones and high-tech clusters. The initial Jebel Ali Free Zone, an industrial and trading hub, was followed in the late 1990s by three technological parks: Internet City, planned to create an infrastructural environment that facilitates Information and Communications Technology (ICT); Media City, a project that became a regional hub for many media corporations like CNN, MBC, and Reuters; and Dubai International Financial Center (DIFC), a stock market headquarters meant to link between the east and the west serving as an entry for the flow of investment and capital to and from the region to intensify the city's connection to global capital markets (Katodrytis, 2005). In addition to these specialized free zone enclaves, Dubai is also planning to build a Humanitarian Aid City as a base for disaster relief; a Motor City a free-trade zone dedicated to the sale of used cars; a Dubai Metals and Commodities Centre; Healthcare Village, in collaboration with the Harvard Medical School; a Sport City; an academic city, and other series of specialized cities within a city. Davis (2007) argues that Dubai has created what American reactionaries only dream of, zones of free enterprise without income taxes. (Alawadi, 2011).

Today, if we look at Dubai map, it appears that the urban areas are concentrated in six main areas. First, there is the existing city, long and narrow, stretches along the shore. Second, there is the old central downtown with two distinctive parts alongside the creek: Bur Dubai and Deirah. Third, there is the new downtown area which is planned as a linear form along Sheikh Zayed Road. Fourth, there is the Gulf water and the projects that are being built in offshore; some of them are few miles from the original

shoreline, and others are along the shore. Fifth, there is the desert expanding and embedding into the city's structure in which its original coastal linearity are changing and becoming wider. Finally, there is the sky, where there is no limitation of height, scale, and density (Machado, 2006a).

3.1 THEORETICAL BASIS

Two broad categories of notions could be distinguished regarding urban design strategies. These two main idea are in one hand physical point of view about the city form (physicality) and on the other hand physical morphology of the city plus psychological, perception and social dimensions of the city formation as well. Le Corbusier, Ebenezer Howard and Frank Llyod Wright could be classified among the first group thinkers and Jane Jacobs and Kevin Lynch among second group theorists who believed more on activity, diversity and vitality (Jacob) and also sensory experiences, cognition, and elements of good city form.

The second group of ideas introduced since 1960's, the trend that shifted from big utopia and comprehensive solutions to city form and development.

Unlike the classical urban design debates that are recognized by the work of several individuals such as Howard, Wright, Jacobs, and Lynch, The contemporary debates are taking place at the global, national, regional, and local governmental levels through the visions of different segments of the population, including politicians, scholars, practitioners, and citizens.

There is currently a strong debate underway about the role of urban design in promoting sustainable development and the big question is: Which Urban forms will effectively deliver greater environmental social and economic coherence (Brehney, 1996).

The question is exactly in relation to our two before mentioned research questions. To answer these questions first in a descriptive study will analyze a variety of urban lack and deficiencies in development projects in Dubai and in the next step has been tried to find different appropriate solutions and aiding strategies to provide advantageous urban development and to diminish existing known disadvantages as well.

3.1 Classification of different urban disadvantages and concern in Dubai Urban development

Table 1 Urban Development lacks and concerns in Dubai

Urban development disadvantages	Different Aspects of the related disadvantages
--	---

<p>Fragmentation (Physical & Social)</p>	<ul style="list-style-type: none"> - Developments are not contiguous, described as dispersal urbanism or scattered developments - Urban areas are divided and mainly linked by highways and roads - Exclusion and isolation: domination of many gated communities and gated tower complexes as well as several private and self-contained urban projects - Public spaces are privatized or semi-privatized in shopping malls and along waterfront developments - The urban experience is repetitive and redundant based on entertainment, tourism, consumption and marketability - There is no concern about land preservation. Disaggregated urban projects expand massively along the gulf shore and in the desert, wasting large tracts of lands. - There is no symbiotic relationship between buildings and landscape, or people and different uses.
<p>Lack of Connection</p>	<ul style="list-style-type: none"> - Intensive automobile accommodation. There is an extreme rise in automobile usage. Dubai is basically an automobile dependent city. - Dubai's statistical data showed that no more than 6% of the population use the bus system and motor vehicles increase by an annual average of about 12% (Albayan, a local news paper, March 2008). - There has been an increase of 30% in the number of vehicles in Dubai, according to the 2005 figures (Corder, 2008). - Vehicles in Dubai take 3.1 million trips a day, a figure expected to increase by 2020 to 14.3 million trips a day (Albayan, March 2008). - Lack of pedestrian accessible places - Dendritic (tree-like) street system is dominant. Ergo walking is difficult and cars are the central mode of transportation even for very short trips. - Interconnected street patterns and urban blocks are not used or preferred in the built form design. - Urban communities are not served by a transit system which is linked to the city's central rail system (the green and red lines). - There is a lack of greenways or urban green corridors - The parks in Dubai are mainly accessible by car - There is no interconnected park system

<p>Segregation</p>	<ul style="list-style-type: none"> - The urban form focuses on a select portion of the population (e.g., tourists, international residents, and high income people) rather than supporting diversity or focusing on local needs. - Ethnic and socio-economic segregation. Many low and middle income classes live in adjacent cities for affordability purposes. Many locals have their own subsidized neighborhoods. Other, including high and middle income classes live in new mega projects i.e tower complexes, gated communities, islands or themed projects, while the working classes live in old districts and in labor dorms. - There is no variety and diversity in the urban form and the architecture of mega developments since most of the developments both are repetitive and redundant, like the eclectic array of palm tree shaped island projects. - Developments either are mega, vertical, off-shore, excessively themed, or exclusive rather than inclusive or diverse (Machado, 2006b) - Dubai is mainly based on a homogeneous type of urbanism in which the city becomes a pure enterprise for segregated mega developments and foreign investors. This urbanization trend predominantly focuses on selling, and its - Success is linked to its marketability and profit (Katodrytis, 2005; & Doherty, 2008). - Public spaces are mainly privatized and primarily associated with shopping malls, commercial corridors, and located along waterfront developments (Moustafa & Rifki, 2007).
<p>Erosion of Local Culture</p>	<ul style="list-style-type: none"> - New mega developments do not target the housing needs of native people - Native people are experiencing a sense of isolation because use of their language is diminishing with the influx of the foreign population. - Social stratification of city population is becoming more critical: According to the Under-Secretary of the Ministry of Labor, a total of 202 different nationalities exist in the labor market in the UAE. The country has one of the greatest rates of foreign nationalities. The expatriate workers reached 2.6 million by 2006. Indians comprise 50% of the total number of

	<p>employees working for the private sector while Pakistanis account for 18% (Khaleej Times, a local news paper, 2006).</p> <p>The 2007 population figure indicated that there are 864,000 UAE nationals and 3.62 million expatriates in the UAE, the bulk of who base themselves in Abu Dhabi and Dubai.</p> <p>A study conducted by Benton-Short, Price, & Freidman (2005) ranking cities in terms of immigration indicated that Dubai has the highest percentage of foreign-born residents (82%), followed by Miami (51%), and Amsterdam (47%) (Cited in Elsheshtawy, 2008).</p> <ul style="list-style-type: none">- Cultural norms, including preferences for maintaining privacy, are not an explicit component in the design of subsidized local neighborhoods or in the mega projects.- Many mega projects don't incorporate sites of religious pilgrimage.- There is a dramatic shift in the social activities and communication from neighborhood or family-centric networks to market driven relations that take place in shopping malls, hotels, and other kinds of privatized spaces.- The influx of the working class deteriorated many old housing districts and created ethnic enclaves due to lack of appropriate and affordable housing stock for population segment.- The focus on marketing the city as driving development created urban contexts with new and diverse cultural norms that are changing the local culture of the area.- The current urban design strategy emphasizes developing mega projects, branding the city, creating a global identity for the city, consuming luxury items and commodities, marketing this urban form itself rather than responding to the cultural norms and to the environmental conditions of the place.
--	---

<p>Form and Function of the Landscape</p>	<ul style="list-style-type: none"> - Landscape is seen as a real estate icon (Doherty, 2008). The focus centers more on the form and economic function of the landscape and less on its cultural and environmental functions. For example, the city focuses on large-scaled green, open spaces (albeit treeless) that serves several gated communities and golf courses. These communities are marketed as a luxury life style that increases the local real estate value. - Urban communities lack playgrounds and sport fields. - The green system in Dubai is not well integrated into where people live or work.
<p>Environmental Deterioration</p>	<ul style="list-style-type: none"> - High levels of air pollution: A study indicated that Dubai ranks among the worst in the world using an On-road Vehicle Emission Measurement device, which assigns a percentage score for the levels of harmful pollutants including hydrocarbons, carbon monoxide, nitrogen oxides, and carbon dioxide (Corder, 2008). - Temperature increase: The Meteorologist Office indicated that in May 2009 temperatures soared to their highest levels in 23 years. The daytime temperatures on May 26th reached 46.3° C, just marginally lower than 47° C, the record temperature recorded in May 1986 (Building Boom Turns up the Heat, 2009). - Increase in urban heat islands effect - Overconsumption of natural resources - High levels of waste, especially construction and solid waste (Malik, 2008): In 2007 the city had one out of six operating cranes in the world. Construction and demolition waste constitute 75% of the total solid waste generated globally every year. From 2006 to 2007, the volume of construction and demolition waste in Dubai increased by 163% to nearly 28 million tons, as compared to 10.5 million tons in 2006. Eight million tons are recycled each year, with the remaining amount going to landfills - Lack of renewable energy sources and plan - Lack of passive solar design tactics - Developments are unresponsive to local climate - Excessive consumption of energy and water: Dubai is ranked number one in the world in terms of

	<p>growth in energy and water requirements. For example, electricity growth was 15% and water almost 12% (per capita) in 2007 (Sinclair, 2008). From April to November each year, 75 to 85% of power consumption is for cooling purposes (DEWA, 2008).</p> <p>A study conducted by the Emirates Industrial Bank indicated that the UAE has one of the highest water consumption levels in the world (almost 130 gallon/day) compared to western countries. This stems from its extreme climatic condition and high per capita income (Sinclair, 2008).</p> <ul style="list-style-type: none"> - The UAE had the highest ecological footprint in 2004 as well as 2006: According to the World Wide Fund for Nature (WWF) Living Planet Report 2004, the global ecological footprint was 2.2 global hectares per person, while the ecological footprint of the UAE resident was 9.9 hectares, the highest in the world (Krane, 2007). In 2006, another WWF report indicated that the global ecological footprint remained the same, while for the UAE it increased to 11.9 hectares, once again the highest in the world (Mitchell, 2007).
<p>Regulation and Public Participation</p>	<ul style="list-style-type: none"> - The recent urban form in Dubai is homogenous and lacks sufficient connectivity to the existing city fabric and other mega developments. - Urban developments in Dubai have been mainly unplanned and unregulated. The investors are setting up their own needs because there are no solid regulations to control them (Record News, 2008).- - There is no environmental protection agency. - Sustainability standards are not imposed on developers. The first complete regulatory action will take place in 2015 through an Emirates version of LEED. However, it is not comprehensive as it regulates only buildings, not the urban form or large scale developments - The city's agenda primarily relates to attracting foreign investment and capital. - The private-public partnership of the municipality restricts and does not promote involvement of the public in decision making processes related to development projects.

Source: Adopted and modified from Khaled Abdulrahman Alawadi; 2011.

3.2 What kind of Development strategies and approaches could be integrated as a systematic and holistic optimum Solution

Due to the accelerating rate of environmental and social emergencies, as well as the increase of urban population around the globe, a single monocentric compact region might not be the best to achieve a more sustainable urban form. As a result, it is essential to think about new sustainable city forms.

The physical atmosphere of this city does not need to be a traditional compact mass; instead, it may explode into small urban areas or several specialized districts, each having a distinct flavor and function. Binding these urban agglomerations together would be the merits and attributes of the compact city like social integration, density, diversity, accessibility, and an effective transit system (Jenks & Kozak, 2008; Okabe, 2005; Thomas & Cousins, 1996).

This model, which is often described as a polycentric urban network, has become increasingly important within the current urban debate. It can refer to different urban scales of the built environment, whether at the world, national, regional, or city level. It is described by different terminologies, such as polycentric regions, polycentric urban systems, multimodal urban systems (these being centers, sub-centers, or nodes), and networks (being a system of linkages that connect such sub-centers and nodes) (Jenks & Kozak, 2008).

Polycentrism is also characterized either as a phenomenon that has evolved over time, or as one that is totally new, resulting from good planning (Faludi et al., 2002). One of the most common definitions of polycentrism is as follows: —A series of anything between 10 and 50 cities and towns, physically separate but functionally networked, clustered around one or more large central cities, and drawing enormous economic strength (Faludi et al., p. 3).

The dangerous and negative side of polycentrism appears when people misinterpret it to mean fragmentation and sprawl. This issue can be addressed in three questions: What are the differences between polycentric development and fragmentation? Is polycentric development just a form of organized sprawl? Are new urban centers or nodes integrated into a polycentric system, or they are just fragmented sub-centers set within what appears to be polycentric in form (Jenks, Kozak, & Takkanon, 2008)

3.3 Whether New Urbanism is another Solution?

Congress for the New Urbanism, the organized body of the movement found in 1993, has a number of task forces working on issues such as the

environment, education, community and social equity, public participation, transportation, and inner-city conditions (Ellis, 2002). I link the strength of new urbanism to its applicability on many scales. In fact, the CNU Charter is composed of three sections (the metropolis/city/town; the neighborhood /district/corridor; and the block/street/building).

Each section has nine principles for a total of 27. Another positive aspect of new urbanism is that its strategies are practiced both in urban in-fill projects and in totally new developments. New urbanists demarcated a very specific set of dimensions for the shaping of urban form, as opposed to the abstractions and wording of some other models. In fact, its dimensions mostly are written into codes known as smart or form-based codes, which are commonly generated from public participation processes (Talen & Cliff, 2002).

Douglas Farr (2008), in his book *Sustainable Urbanism: Urban Design with Nature*, argues that smart Growth, New Urbanism, and Green Building Standards (LEED) create a pathway to a sustainable life style and provide the philosophical and practical foundations of urban sustainability.

The adoption of compact, high density, mixed land uses; walkability; interconnected street systems; preservation of environmentally sensitive areas; less auto-dominated landscapes, and alternative modes of transport lead to fewer emissions, more land preservation, less reliance on cars, less pollution, and less environmental degradation.

The biggest and most important lesson about town building is that buildings alone don't matter because what compromises the basis of town making is the ensemble of streets, blocks, landscapes, and buildings, and the way they fit together (Solomon, 1992). Lastly, the model is very influential in city design; however, it needs a lot of improvement in the areas of urban morphology, technology, ecological protection, and social equity.

3.4 Urban Metabolism and Urban Sustainability in Dubai as an another necessity

Sir Richard Rogers argues in his book *Cities for a Small Planet* for the necessity of new form of planning that replaces our linear approach to pollution and resource consumption in cities with a circular sustainable system (Rogers, 1997). The key idea of the urban metabolism model is that cities must begin to look for ways in which outputs represent productive inputs or food for other processes in the life cycle (Beatley, 2000).

Currently, most cities utilize a linear metabolism system in which resources flow in and wastes flow out, unlike natural ecosystems in which resources cycle in the system (Girardet, 1992; 2001). As a result, cities need to close resource cycles and adopt a more circular metabolism with recycling, treatment and reuse of waste and grey water, and management of

storm water and floods.

The ecological footprint provides a useful measure of the scale of city's metabolism. The ecological footprint of a city measures the amount of land it takes to support the basic needs for food, water, energy, and materials, and to absorb greenhouse gas emissions and other waste. Minimizing the ecological footprints of cities embodies a huge task that will require changes not only to city form and operation but also to the way that people live. Bringing production and consumption back to a balanced condition is an important sign of city's well-being and sustainability (Newman & Jennings, 2008).

The future task is to generate an eco-balancing model that has more direct input into the structural design of urban areas (Beatley, 2000). That this model can't be considered as a comprehensive model of urban sustainability because it predominantly focuses on environmental sensitive practices without emphasizing the social and human realities of urban settings.

Other drawbacks associated with this model are attributed to the fact that eco-cycle design approach is cost-intensive, very sophisticated, and highly technological; As a result, it might not be adopted or used effectively throughout the world, especially if it contradicts the level of financial resources, the level of expertise, current agenda of development and growth, and lastly the political well.

4. SYNTHESSES AND CONCLUSION

A non-sustainable city would be recognized by population decline, environmental degradation, inefficient energy system, inefficient transport systems, a loss of employment, emigration of industry and services, social stratification, loss of cultural identity, fragmentation, and segregation.

There is no complete consensus on the definition, typology, characteristics, or dimensions of a sustainable city. In fact, this paradigm is still an unanswered question.

Part of the problem stems from the complexity of our cities, as each region has specific cultural values, social norms, political systems, economic capabilities, and environmental qualities. Another part of the problem is due to the complication surrounding the term sustainability itself.

Although there is no agreement among them about the nature of the sustainable city, or about which urban forms contribute more to sustainability. The sustainable city is farther away from Le Corbusier's homogenous replicable towers, but closer to his vision of concentration and density. The sustainable city deviates completely from Wright's individuality, auto-dependent, and decentralized low density developments.

The sustainable city is closer to Howard's magnet of town and countryside. It is closer to his density levels, connected satellite towns, and

his ideas that advocate the protection of countryside. The sustainable city has Jacob's diversity, choice, vitality, and human base animation.

It is the city where there is no excessive and unjust spatial separation of income and ethnic groups. The sustainable city is where residents have equal access to services and amenities, and where economic opportunities and housing are available for all segments of population. The sustainable city does further a daily interaction of people, classes, businesses, and work. The sustainable city also reflects Lynch's imagineability, legibility, aesthetic and visual experience, and sense of place and time. It also has his dimensions of city performance: vital, sense, fit, access, and control.

The urban elements and image of the sustainable city should also make a strong impression on the individual's perception, comprehension, understanding, and experience.

The sustainable city has a circular, not linear, metabolic system that balances production and consumption. The sustainable city has new urbanism's participatory approach to urban design and planning. The sustainable city embraces the idea of public participation and the spirit of diverse and cumulative opinions.

The sustainable city has the characteristics of the compact city: diversity, mixed-use lands, connectivity, contiguity, walkability, proximity, and control. But if the compact city faces an intense urban and population growth, the sustainable city should be polycentric in form and characteristics. In this situation, the sustainable city would be spatially and socially connected, inclusive and accessible to all.

REFERENCES

- Alawadi, K. (2011). Rethinking Dubai's Urbanism: Generating Sustainable Form-Based Urban Design Strategies for an Integrated Neighborhood.
- Van Helmond, T., & Van Montfort, B. (2007). Urban development in Dubai. Eindhoven university of technology.
- Al Sammani, A. (2011). The Sustainable Development of Local Housing Units in UAE. The British University in Dubai.
- DUBAI 2020 URBAN MASTER PLAN, Entry Submission to the 2012 ISOCARP Awards for Excellence. (2012). Dubai Municipality, Planning Department.
- J. Ramos, S. (2009). The Blueprint: A History of Dubai's spatial Development Through oil Discovery. Belfer Center for Science and International Affairs Harvard University, Kennedy School.
- Elsheshtawy, Y. (2008). Transitory sites: Mapping Dubai's forgotten urban spaces. International Journal of Urban and Regional Research.
- Davis, M. (2007). Fear and money in Dubai. Retrieved August 1, 2009, from <http://www.newleftreview.org/?view=2635>.
- Elsheshtawy (Ed.), Planning the Middle East City: An Urban Kaleidoscope in a Globalizing World, Routledge: London.



NO.81

An Analysis of Taipei City's Bicycle Safety to Explore Strategies Improving the Urban Design.

Jen-Te Pai¹ and Pin-Yi Liu^{1*}

1 National Chengchi University

** Corresponding Author, Email: 102257015@nccu.edu.tw*

Key words: Accident severity, Multinomial logistic regression

Abstract: In the past, the development of city and road planning deemed the motor vehicle as the main part, and the traffic environment of bicycle is relatively unfriendly. With the domestic bicycle usage has increased in recent years, the data show the probability of bicycle accidents have raised tendency. It shows that on roads safety of bicycle requires more attention. Therefore, this study will analyze the bicycle accident data of Taipei to identify factors that affect the severity of the accident, and then improve the current environment of bicycle by urban design to enhance bicycle safety.

The analysis is based on police-reported accident data between 2008 and 2012 from Taipei, Taiwan. Through this study, we understand the characteristics of accident data by a frequency analysis. Besides, this research explores the factors contributing to the injury severity of bicyclists in bicycle accidents using a multinomial logistic regression that considers environmental factors, roadway conditions, and rider attributes. The model predicts the probability of three injury severity outcomes: fatal or head injury, injury, and no injury.

The results showed that the factors leading to increased probability of accident include accident victim, age below 18 and older bicyclist, drunk driving, riding straight, the accident location for the type of road junctions especially four legged intersection, or because of the curve or the building caused by poor line of sight. Moreover, results show that bicyclist injury severity level could be reduced by wearing appropriate safety gear and equipment or riding on wet pavement.

NO.82

Green-energy Water-autonomous Greenhouse System *An Alternative-technology Approach Towards a Sustainable Smart-green Vertical Greening in Smart City*

Paiyao Hung¹ and Kuanghui Peng^{1*}

1 College of Design, National Taipei University of Technology

** Corresponding Author, Email: tdbhome.taikupo@msa.hinet.net ; khpeng@ntut.edu.tw*

Key words: Green-energy water-autonomous greenhouse system, sustainable, smart-green, vertical greening, smart city

Abstract: Under the overall umbrella concepts, both of “green” and “smart” could be converged into “smart-green” on the basis of material and technologies, resources, and environment. By means of “going greener” and “getting smarter”, a smart city could address the steps toward more and more sustainability. Conventional vertical greening are used to be in open field, unprotected, lacking in better control of climate conditions and plant-response-based circumstances, then are always taking the challenges called energy saving, reduced CO₂ emission, reduction in water use and in pesticide use. A closed or semi-closed greenhouse system could instead solve different facets of the problems in conventional vertical greening because that a greenhouse system which minimizes the use of water and energy could be developed by an increasingly sophisticated and multi-disciplinary approach to achieve an optimal balance between an efficient environmental control and efficient plant use of available resources, appears to be intellectually justifiable, seems to be much adaptable and innovative, and much easier to be smart-green and sustainable in smart city. A green-energy water-autonomous greenhouse system could be proposed to be an alternative-technology approach towards a sustainable smart-green vertical greening in smart city since the system are mainly conducted by having a considerable reduction of the need of water due to stable closing small water cycle inside the greenhouse with the recovery of evapotranspiration and condensation and by integrating networking solutions of the system which converges green and intelligent technology to improve responsiveness, efficiency, and performance, and all these advantages were achieved by using solar energy. The purpose of this paper are to summarize the major concepts and trends of new greenhouse technologies by reviewing relevant research and to present a novel prototype in green-energy water-autonomous greenhouse. The system is expected to incorporate a variety of greening in to buildings and to open interesting possibility for increasing attractiveness of cityscape and to enhance progressive urban revitalization.

1. INTRODUCTION

1.1 Background

Cities around the world are faced with complex social and ecological challenges and problems caused by population growth, urbanization, and climate change. To envisage these challenges and problems, cities are increasingly concerned with providing a more resource-efficient and environmentally-responsive answer, so as to strengthen future viability of the city and to improve the quality of life for citizens in future urban communities. Accordingly, the use of the term “green city” and “smart city” has sharply increased in recent years.

Both of “green” and “smart” are umbrella terms. According to Attmann, “green” involves a combination of values—environmental, social, political, and technological—and thus seeks to reduce the negative environmental impact by increasing efficiency and moderation in the utilization of materials, energy, and development space. Green is an abstract concept, which requires the inclusion of the terms: sustainability, ecology, and performance (Attmann, O. (2010)). According to Hatzelhoffer, considering the term from an Anglo-American perspective, “smart” can have a whole array of meanings. It can be used in the sense of brisk, elegant, competent, or fashionable, as well as meaning clever or intelligent (Hatzelhoffer, L., Humboldt, K., et al. (2012).). The international scientific team led by Caraculiu (2009) drew up six criteria and formulated the definition of a smart city : “ We believe a city to be smart when investments in human and social capital and traditional (transport) and modern (ICT) communication infrastructure fuel sustainable economic growth and a high quality of life, with a wise management of natural resources, through participatory governance.” (Hatzelhoffer, L., Humboldt, K., et al. (2012).

According to Posada, Sustainability is broader in its reach than green, addressing the long-term impacts of the built environment on future generations and demanding an examination of the relationship between ecology, economics, and social well-being. (Kwok, A.G. and Grondzik, W.T. (2011).). Under the overall umbrella concepts, both of “green” and “smart” could be converged into “smart-green” on the basis of material and technologies, resources, and environment. By means of “going greener” and “getting smarter”, a smart city could address the steps toward more and more sustainability.

Vertical greening, according to Kuang-Hui Peng et al., can increase greening amount, reduce urban heat island effect, improve the quality of outdoor and indoor air, beautify urban landscape, lower indoor temperature, increase energy efficiency, protect building structure, and reduce noise, and expanding the use of vertical greening is a good way to rehabilitate high-

rise congregated house building façade and sustain the green wall system for improving sustainable environment (Peng, K.H., Kuo, Y.C., et al. (2015).). However, conventional vertical greening are used to be in open field, unprotected, threatened by climated disasters such as high wind speed and heavy rainfall, lacking in better control of climate conditions and plant-response-based circumstances, then are always taking the challenges called energy saving, reduced CO2 emission, reduction in water use and in pesticide use. Moreover, beyond the environmental function of providing horticultural cultivars to urban landscape, vertical greening can also be a type of agricultural cropping for food production in city, even though the vertical greening already have involved a combination of values of environmental quality in its utilization of materials, energy, and development space, the water scarcity and the large demand for primary energy still are serious handicap for the sustainability of the actual production system.

Although on one hand, progrssive technological solution developed from traditional to modern and from conventional to unconventional for energy-efficiency, water-efficiency, and resource-efficiency will help vertical greening itself to be smart-green and sustainable in smart city.

But on the other hand, a closed or semi-closed greenhouse system could instead solve different facets of the problems in conventional vertical greening because that a greenhouse system which minizes the use of water and energy could be developed by an increasingly sophisticated and multi-disciplinary approach to achieve an optimal balance between an efficient environmental control and efficient plant use of available resources, appears to be intellectually justifiable, seems to be much adaptable and innovative, and much easier to be smart-green and sustainable in smart city.

A closed or semi-closed greenhouse system also could incorporate a variety of greening into buildings on walls and openings and thus to open a very interesting possibility for increasing attractiveness of cityscape and to enhance progressive urban revitalization in smart city.

1.2 Motivation and Objectives

A green-energy water-autonomous greenhouse system could be proposed to be an alternative-technology approach towards a sustainable smart-green vertical greening in smart city since the system are mainly conducted by having a considerable reduction of the need of water due to stable closing small water cycle inside the greenhouse with the recovery of evapotranspiration and condensation and by integrating networking solutions of the system which converges green and intelligent technology to improve responsiveness, efficiency, and performance, and all these advantages were achieves by using solar energy .

The purpose of this paper are as follows:

1.To summarize the major concepts and trends of new greenhouse technologies and approaches by reviewing relevant subjects of research that focus on water saving, energy management, natural ventilation and the integrations for a greenhouse system to be sustainable and smart-green .

2.To present a novel prototype of green-energy water-autonomous greenhouse system and to discuss the innovation and advantages of the system which proposes incorporating greenery into buildings as an alternative of vertical greening in smart city.

A green-energy water-autonomous greenhouse system for sustainable smart-green vertical greening is expected to incorporate a variety of greening into buildings on walls and openings and thus to open a very interesting possibility for increasing attractiveness of cityscape and to enhance progressive urban revitalization in smart city.

2. LITERATURE REVIEW

2.1 New generation greenhouses

For overcoming drought, the Cycler Support (Buchholz, M., Schmidt, M., et al. (2008).). had aimed to investigate the potential of growing food on the base of unconventional water sources and so as to describe a long term scenario includes a new generation of water efficient greenhouses. A group of new greenhouse technologies allows to collect condensed water from air water vapour within greenhouses. By using this kind of much less conventional water together with harvested rainwater, it is possible to reach a water autonomous situation of irrigation water supply in many regions of the world. A major point is that the natural water cycle can be circumvented and water efficiency can be drastically improved by new greenhouse technologies. Even a greenhouse could provide condensed water regained after being evaporated by plants with recycling rates of up to 80% and reduced water consumption compared to open field intensive production of 95%. In the Cycler Support, a number of 5 new generation greenhouse model research areas are proposed, including (1) closed greenhouse for food, (2) closed greenhouse for non-food crops including greenhouse integrated solid state fermentation, (3) open greenhouse with natural convection, built on mountain slopes, using saline water from the sea for evaporative cooling, integrated aqua farming for fish and algae production using waste water and solid waste from fish procession, (4) model urban area for wastewater pre-selection in urban areas with use of greywater in greenhouse projects, (5) concentrated solar power project with cooling water recycling in closed greenhouses. (Buchholz, M., Schmidt, M., et al.

(2008).).

The Naples event of the Greensys2007 symposium (Giacomelli, G. (2007).) demonstrated that the room for improvement in greenhouse cropping is there. About innovation in greenhouse engineering, Giacomelli points out in his address that: (1) greenhouse components and design directly impact on crop growth, (2) correctly assessing the importance of crop-greenhouse interactions is needed, (3) real-time measuring of a maximum number of parameters is necessary, (4) other than the Watergy project, engineers have to find the ways and means to substantially reduce energy and water use and to ensure that an acceptable return on investment can be achieved when high enough yields were produced (Giacomelli, G. (2007).). In the opinion of Prof. Stefania De Pascale, convenor of Greensys2007, a greenhouse system is in some respect already an energy-saving system compared to the open field agriculture and is an excellent environment to achieve an optimal balance between an efficient environmental control and an efficient plant use of the available resources. And in Naples, the main focus was on a famous prototype of closed greenhouse named Watergy (Giacomelli, G. (2007).).

2.2 Watergy project

The research of Watergy project is funded by European Union's Vth Framework Program promoting Energy, Environment and Sustainable Development (Zaragoza, G., Buchholz, M., et al. (2007).).

The Watergy project proposes two prototypes of application of a novel humid-air solar collector. The first is constructed in Almeria (Spain), and it is a closed greenhouse for solar thermal energy capture, water recycling, water desalination and advanced horticulture use. The second is constructed in Berlin (Germany), and it is a greenhouse with an autonomous supply of heat and also of clear water, and is connected to the building and purifies its residual grey water. In the context of sustainable architecture, the Watergy system means that this concept of zero energy is complemented with that of water autarchy. The autonomous and local way to treat urban residual water means that, on one hand, the decentralization of water supply can be contemplated with self sufficient systems able to close their water cycle locally, on the other hand, intensive agriculture can be freed from its enormous water consumption. The concept of solar collectors is that, on one hand, the humid air allows to store more thermal energy at a given temperature and the same amount of energy can be transported by much lower air volume flow sustained by natural buoyancy, on the other hand, the evaporation and condensation processes increase the efficiency of the heat transfer (Zaragoza, G., Buchholz, M., et al. (2007).).

The Watergy project were widely discussed from many subjects of

research include: (1) thermal control for optimized food production and greywater recycling by a new solar humid-air collector system (Buchholz, M., Zaragoza, G., et al. (2004).), (2) the functioning of the system for solar thermal energy collection, water treatment and advanced horticulture (Zaragoza, G., Baeza, E., et al. (2005).), (3) use the simulation environment Smile to simulate thermal and fluid dynamical processes including water interactions between plants and air (Jochum, P. and Buchholz, M. (2005).), (4) to described passive cooling and dehumidification strategy (Buchholz, M., Buchholz, R., et al. (2006).), (5) critical discussion following the results of El Ejido in Almeria, Spain (Zaragoza, G. and Buchholz, M. (2008).), (6) to explore a suitable method to provide required automatic adaptation to an adaptive model for greenhouse control (Speetjens, S.L., Stigter, J.D., et al. (2009).), (7) to develop a physics-based model, based on enthalpy and mass balances, to predict the systems behaviour (Speetjens, S.L., Stigter, J.D., et al. (2010).)

2.3 Water saving

The water saving concepts were also discussed from many subjects of research include: (1) novel high technological solutions in greenhouse production can lead the way to highly efficient water use production techniques, can alleviate the water shortage problem (Van Kooten, O., Heuvelink, E., et al. (2008).), (2) the technical aspects and results of a trial using a fully closed greenhouse showed advantages in reduction in energy, water, and chemical crop protection (Opdam, J. J. G., Schoonderbeek, G. G., et al. (2005).), (3) compared to irrigated crops outdoors, the seasonal ET of the greenhouse horticultural crops is relatively low due to the lower evaporative demand inside the greenhouse (Orgaz, F., Fernandez, M.D., et al. (2005).).

2.4 Energy management

The energy management concepts were also discussed from many subjects of research include: (1) the final energy efficiency is determined by improvements in energy conversion, reductions in energy use for environmental control and the efficiency of crop production, and the developments range from new modified covering materials, innovative and energy conservative climate control equipment and plant response based control system, to integrated energy efficient greenhouse designs (Bakker, J.C., Adams, S.R., et al. (2008)), (2) the greenhouse system was treated as a solar collector having an absorber plate (the greenhouse soil) and a cover system consisting of three semi-transparent parallel layers (the greenhouse

cover, the humid air, and the plants), and there are some general relations for estimating the amounts of solar energy absorbed by the greenhouse components and lost to outside the greenhouse (Abdel-Ghany, A.M., Al-Helal, I.M. (2011).), (3) an energy management concept is to maximize the utilization of solar energy through seasonal storage by removing excess sensible and latent heat because of no ventilation in a fully closed greenhouse, and although higher amount of solar energy can be harvested in a fully closed greenhouse but in reality a semi-closed greenhouse concept may be more applicable (Vadiee, A., Martin, V. (2012).), (4) many thermal energy storage systems like TES, UTES, SCW, PCM, BETS could be considered as the seasonal storage or short term storage, and a theoretical model could be developed to carry out the energy analysis (Vadiee, A., Martin, V. (2013).), (5) fluorescent solar concentrators, photoselective and other materials could be considered to be solar radiation manipulations in greenhouse claddings to provide advantages for plants (Lamnatou, C. and Chemisana, D. (2013).).

2.5 Natural ventilation

The natural ventilation concepts were also discussed from many subjects of research include: (1) relative to a naturally ventilated greenhouse, wind direction significantly affected the flow patterns both inside the greenhouse and at the roof openings, also affected the ventilation rate and the air and crop temperature distributions (Teitel, M., Ziskind, G., et al. (2008).), (2) excessively high internal temperatures have negative effects on the yield and quality of almost all greenhouse crops because that ventilation is generally insufficient, and the reduced CO₂ levels and the creation of high humidities adversely affects inside air composition, and condensation on the cover also reduces the transmission of solar radiation (Perez Parra, J., Baeza, E., et al. (2004).), (3) to maximise ventilation when wind speeds are low, buoyancy-driven ventilation combined roof and sidewall ventilation should be used (Baeza, E.J., Perez Parra, J., et al. (2009).), (4) there is a unique relationship between water use efficiency and the coupling of greenhouse environment to the outside air, increasing the capacity of the cooling system could reduce ventilation needs of semi-closed greenhouse and so to increase water use efficiency (Katsoulas, N., Sapounas, A., et al. (2015).).

2.6 New approaches of technology

The new approaches of greenhouse technology were also discussed from many subjects of research include: (1) all three geographic areas share

the need of having an optimised climate control based on the crop response to greenhouse environment, for more efficient greenhouse, the progress in Northern Asia is being as a solar collector and to develop new heating strategies, important subjects addressed in Netherlands are energy conservation and increasing mechanisation, in the Mediterranean there is growing interest in semi-closed greenhouse with CO₂ enrichment and control of excessive humidity (Montero, J. I., Van Henten, E. J., et al. (2011).), (2) to achieve a sustainable greenhouse that is energy neutral, consumes only the essential amount of water, and has minimal negative environmental impact, recent years have witnessed the development of photovoltaic cells for power generation, insect-proof screens, and the use of tools of CFD simulations to investigate the effects of structure shape, ventilator size and arrangement on microclimate (Teitel, M., Baeza, E. J., et al. (2012).), (3) the low energy concept could be contribute by combining energy saving methods with an improved control of greenhouse microclimate and also by improving the cropping system and using new cultivars, so the closed greenhouse has been developed and propagated as an energyproducing greenhouse and the greenhouse should be operated semi-closed to improve the use of solar energy for heating (Tantau, H. J., Schmidt, U., et al. (2011).), (4) passive greenhouse use only the renewable energy sources like geothermal, wind and sun, by means of cool water heat pumps, wind turbines and photovoltaic panels, thereby they are fully free of any energetic infrastructure and can be installed in remote areas, so offer a fundamental sustainable agricultural resource and a global ecological reconstruction opportunity (Balas, M. M. (2014).)

2.7 Vertical greening technology

According to Peng, K.H., Kuo, Y.C., et al., vertical greening of the building related items with impact factor were pointed out as follows : (1) for item of plants, the factors are category, growth nature, cco-nature, planting method, maintenance method, growth period, and sense, for items of vertical greening technology, the factors are climbing, hanging, and module, for items of building external environment, the factors are building type, greening position, impact factor, additional substance of façade, community environment, material of façade and disaster. On the influencing factors mentioned above, the wall microclimate in wind environment, the illumination of sunshine, the temperature changes are needed to be carefully handled, and it is especially necessary to find suitable treatments for rising wind, descending wind, and whirlpool and prevent construction side from being stripped by the wind(Peng, K.H., Kuo, Y.C., et al. (2015).).

According to Hemming, S., Speetjens, S. L., et al., in Taiwan, open field vegetable production is threatened by subtropical climatic disasters, such as

high wind speeds and heavy rainfall, which can cause the destruction of whole crops, also the vegetable production is threatened by pests and diseases resulting a high need for pesticides, and the greenhouse production systems are able to provide protection for the crop (Hemming, S., Speetjens, S. L., et al. (2014).).

3. GREEN-ENERGY WATER-AUTONOMOUS GREENHOUSE SYSTEM

3.1 A novel prototype of green-energy water-autonomous greenhouse system

Presented novel prototype of green-energy water-autonomous greenhouse system has been patented as an invention in Taiwan for a period from 2015-03-21 to 2031-08-24. The patent number is I-477230.

3.1.1 Technical field of the prototype

The present prototype generally relates to a green-energy water-autonomous greenhouse system; in particular, it relates to a greenhouse system capable of being installed in suspension outside a window in order to automatically supply electric power for its internal operations by means of a solar power generation device configured therein such that a plant ecological environment system similar to a greenhouse can be maintained within the green -energy water-autonomous greenhouse system.

3.1.2 Description of related art

Modern people typically use various indoor plantations to attain the objectives of green environment and spiritual tension release; besides, plants can partially absorb or shield sunlight coming indoors and provide good sound absorption feature, so indoor temperature, humidity, quietness and air purification can be better conditioned. Plants indeed provide marvelous environmental beautification effects, and their vitality and energy also relieve intense emotional pressure of modern people living in big cities, thereby offering senses of pleasure and joy. Hence, some people may utilize the top floor space of certain mansions or buildings and construct a garden or a vegetable farm. However, since this type of top-floored garden or vegetable farm is categorized as public facilities rather than private assets, maintenance jobs may be quite challenging and acquired

indoor green effects may be less desirable than direct plantations inside a room, a house or on a balcony.

It should be understood that indoor plantations also have their drawbacks, which require significant efforts for regular and timely irrigations, and sufficient space is needed in order to prevent messy indoor surroundings. In addition, plants could easily attract insects, so efficient control and management jobs are necessary otherwise more troubles and pressure may be created for users in practicing indoor plantations. Therefore, it would be an optimal solution if a green -energy water-autonomous greenhouse system can be provided, which is allowed to be directly installed in suspension outside a window in order to provide an environment suitable for plants to grow and automatically obtain electric power required for internal operations by means of solar power generation device configured therein such that the green-energy water- autonomous greenhouse system can create in circulation an environment similar to a greenhouse thereby achieving a vegetation and water-saving circulation system.

3.1.3 Summary of the prototype

The objective of the present prototype is to provide a green-energy water- autonomous greenhouse system, wherein the green -energy water-autonomous greenhouse system can be installed in suspension outside a window in order to automatically supply electric power for its internal operations by means of the solar power generation device configured therein such that a plant ecological environment system similar to a greenhouse can be maintained within the window box.

A green-energy water-autonomous greenhouse system capable of achieving the aforementioned objective comprises a frame body, having a plantation trough installed at the bottom; a solar power generation device, installed at the top of the frame body; a thermoelectric cooling chip board, including a plurality of thermoelectric cooling chips; and at least a window body structure, installed on the frame body, wherein the front, rear, left, right and upper frames of the frame body all allow the installation of a window body structure, the thermoelectric cooling chip board is set up within the frame body, the solar power generation device is installed on the top of the frame body, and the solar power generation device is connected to the thermoelectric cooling chip board by way of a battery so as to provide electric power for the operations of the thermoelectric cooling chip board.

Therefore, the solar power generation device converts absorbed light energy into electric energy to drive the thermoelectric cooling chip board to operate, and the operations of the thermoelectric cooling chip board can reduce the surrounding temperature thereby generating condensed water to

drop irrigate the plants cultivated in the plantation trough. In addition, the sunlight illumination further causes the temperature in the green-energy water-autonomous greenhouse system to rise up such that the water molecules within the green-energy water-autonomous greenhouse system may evaporate, and wet, warm air is continuously heated and humidified and ascends by the natural buoyancy and with the assistance from the air circulation enhanced by a built-in ventilation device; as such, a plant ecological environment system can be achieved by way of this continuous circulation process.

More specifically, the frame body includes a front frame, a rear frame, a left frame, a right frame and an upper frame, and the window body structure is installed on the front frame, the rear frame, the left frame, the right frame or the upper frame of the frame body. Moreover, the window body structure in the front frame, left frame or right frame of the frame body may include a prism sheet splitter glass or a dimmer glass.

More specifically, the window body structure may be a manual pushed-out window, an electric projected-out window or a fixed window. Besides, a solar photovoltaic chip can be additionally installed within the window body structure thereby acting as a splitter or dimmer glass to regulate and control the power supply, and the solar photovoltaic chip may include CIGS solar cells.

More specifically, a condensing media may be placed under the thermoelectric cooling chip board such that the cooling terminal of the thermoelectric cooling chip board can reduce the temperature and generate condensed water on the condensing media.

More specifically, the solar power generation device on the top of the frame body may include a mono-crystalline silicon solar photovoltaic panel and a battery, and the battery is connected to the mono-crystalline silicon solar photovoltaic panel and the thermoelectric cooling chip board, wherein the interior of the mono-crystalline silicon solar photovoltaic panel includes a solar photovoltaic chip which can be mono-crystalline silicon solar cells.

More specifically, at least two water storage containers can be added to the inside of the frame body, wherein one of the water storage containers can be placed under the thermoelectric cooling chip board and the other one placed beneath the vegetation media of the plantation trough, and such two water storage containers are connected by way of a water pipeline.

More specifically, the plantation trough includes the vegetation media and at least a plant, wherein the plant may be an ornamental plant or an edible plant, the plantation trough may be a light porous moisture-retentive vegetation media trough and the vegetation media may be the soil or porous moisture-retentive media. Also, at least a siphon can be connected between the vegetation media in the plantation trough and the water storage containers.

More specifically, at least a recycle pipeline and an inlet can be

additionally installed in the green-energy water-autonomous greenhouse system, wherein the recycle pipeline can be used to recycle condensed water or rainfalls, and an end of the inlet is connected to the water storage container under the vegetation media in the plantation trough.

More specifically, an electronic supervisory system can be additionally connected in the green-energy water-autonomous greenhouse system thereby allowing controls over the window body structure (regarding to the open and closure operations as well as illumination adjustments of the window body structure) and the thermoelectric cooling chip board. Moreover, a ventilation device capable of ventilation amount adjustments, a thermo-hygrometer or a barometer can be additionally installed in the green-energy water-autonomous greenhouse system, and the electronic supervisory system controls the ventilation device, the hygrometer, the thermometer or the barometer.

More specifically, at least a heat recycle dehumidification ventilation device can be additionally installed in the green-energy water-autonomous greenhouse system thereby providing the features of inward air dehumidification, heat exchange and ventilation, wherein the heat recycle dehumidification ventilation device may be set up between the bottom of the solar power generation device and the frame body or otherwise between the frame body and the top of the thermoelectric cooling chip board.

3.1.4 Detailed descriptions of the preferred embodiments

The aforementioned and other technical contents, aspects and effects in relation with the present prototype can be clearly appreciated through the detailed descriptions concerning the preferred embodiments of the present prototype in conjunction with the appended drawings.

Refer initially to Figures (1), (2A), (2B), (3A) and (3B), wherein a stereo combinatorial structure view, a front stereo view, a rear stereo view and a lateral view for a green-energy water-autonomous greenhouse system according to the present invention are respectively shown. From the Figures, it can be seen that the green-energy water-autonomous greenhouse system 1 comprises a frame body 11, having a plantation trough 16 installed at the bottom; a solar power generation device, installed at the top of the frame body 11 (and including a mono-crystalline silicon solar photovoltaic panel 121 and a battery 122); a thermoelectric cooling chip board 13 (which includes a plurality of thermoelectric cooling chips 131 and a condensing media 132); and at least a window body structure 14 installed on the frame body, wherein the front, rear, left, right and upper frames of the frame body 11 all allow the installation of at least a window body structure 14. In addition, the thermoelectric cooling chip board 13 is installed on upper side within the frame body 11, the solar power generation device is installed on

the top of the frame body 11, and the solar power generation device is connected to the thermoelectric cooling chip board 13 by way of the battery 122 so as to provide electric power for the operations of the thermoelectric cooling chip board 13.

Besides, it can be appreciated from Figures (1), (2A) and (2B) that the frame body 11 includes a front frame, a rear frame, a left frame, a right frame and an upper frame, and the window body structure 14 is installed on the front frame, the rear frame, the left frame, the right frame or the upper frame of the frame body 11. Herein the window body structure 11 may be a manual pushed-out window, an electric projected-out window or a fixed window, so that in case the window body structure 11 is a manual pushed-out window or an electric projected-out window, as shown in Figures (2A), (2B) and (3B), it can be pushed outward to open in order to perform air circulation for the interior of the green-energy water-autonomous greenhouse system 1. Furthermore, a solar photovoltaic chip can be additionally installed within the window body structure 14 thereby acting as a splitter or dimmer glass to regulate and control the power supply, and the solar photovoltaic chip may be CIGS solar cells.

Also, the window body structure 14 in the front frame, left frame or right frame of the frame body 11 may include a prism sheet splitter glass or a dimmer glass.

Moreover, a condensing media 132 may be placed under the thermoelectric cooling chip board 13 such that the cooling terminal of the thermoelectric cooling chip board 13 can reduce the temperature and generate condensed water on the condensing media 132.

Additionally, the solar power generation device may include a mono-crystalline silicon solar photovoltaic panel 121 and a battery 122, and the battery 122 is connected to the mono-crystalline silicon solar photovoltaic panel 121 and the thermoelectric cooling chip board 13, wherein the interior of the mono-crystalline silicon solar photovoltaic panel 121 includes a solar photovoltaic chip which can be mono-crystalline silicon solar cells.

Yet also, at least a heat recycle dehumidification ventilation device 151, 152 can be additionally installed in the green-energy water-autonomous greenhouse system 1 so these heat recycle dehumidification ventilation devices 151, 152 are capable of providing the features of inward air dehumidification, heat exchange and ventilation, wherein the heat recycle dehumidification ventilation device 151 may be set up between the mono-crystalline silicon solar photovoltaic panel 121 of the solar power generation device and the frame body 11, and the other heat recycle dehumidification ventilation device 152 installed between the frame body 11 and the thermoelectric cooling chip board 13.

Furthermore, as shown in Figure (4), the plantation trough 16 can include the vegetation media 161 and at least a plant 162, wherein the plant 162 may be an ornamental plant or an edible plant, the plantation trough 16

may be a light porous moisture-retentive vegetation media trough and the vegetation media 161 may be the soil or porous moisture-retentive media. Also, at least a siphon 163 can be connected between the vegetation media 161 in the plantation trough 16 and the water storage container 172.

In addition, it can be observed from Figure (4) that at least two water storage containers 171, 172 can be added to the inside of the frame body 11, wherein a water storage container 171 can be placed under the thermoelectric cooling chip board 13 and the other one placed beneath the vegetation media 161 of the plantation trough 16, in which these two water storage containers 171, 172 are connected by way of a water pipeline 18 so as to transfer water held in the water storage container 171 into the water storage container 172.

Next, it can be seen from Figure 4 that at least a recycle pipeline (not shown) as well as an inlet 19 can be additionally installed in the green-energy water-autonomous greenhouse system 1, wherein the recycle pipeline facilitates the recycle usage of condensed water or rainfalls, and an end of the inlet 19 is connected to the water storage container 172 under the vegetation media 161 in the plantation trough 16 such that the user can also irrigate manually via the inlet 19.

In addition to the above-said implementations, other devices can be also configured to the green-energy water-autonomous greenhouse system 1 according to the present prototype. For example, an electronic supervisory system (not shown) may be alternatively connected into the green-energy water-autonomous greenhouse system 1 such that the electronic supervisory system can control over the window body structure 14 and the thermoelectric cooling chip board 13. Furthermore, a ventilation device capable of ventilation amount adjustments (not shown), a thermo-hygrometer capable of detecting the temperature and humidity in the green-energy water-autonomous greenhouse system 1 (not shown) or a barometer capable of detecting air pressure values in the green-energy water-autonomous greenhouse system 1 (not shown) can be additionally installed in the green-energy water-autonomous greenhouse system 1.

The electronic supervisory system can further control the ventilation device, the thermo-hygrometer or the barometer such that the user can monitor remotely the environmental variations within the green-energy water-autonomous greenhouse system 1 and control the ventilation device so that the ventilation device can automatically adjust the states of air speed, air withdrawal and air exhaustion in order to adjust the temperature in the green -energy water-autonomous greenhouse system 1. What is more, the electronic supervisory system also allows the user to remotely monitor the environmental variations in the green-energy water-autonomous greenhouse system, and the electronic supervisory system can control the window body structure to open or close automatically and manipulate the thermoelectric cooling chip board 13 to adjust the internal temperature.

Consequently, as shown in Figure (4), when the sunlight 2 illuminates the mono-crystalline silicon solar photovoltaic panel 121, the solar power generation device converts absorbed light energy into electric energy and transfers electric power to the thermoelectric cooling chip board 13 as well as the ventilation device (not shown); therefore, when the thermoelectric cooling chip board 13 operates, the cooling end of the thermoelectric cooling chip board 13 can reduce the temperature and condensed water created by means of the condensing media 132 can drop down due to gravity and irrigate the plant 162 in the plantation trough 16. Meanwhile, because the sunlight 2 illuminates the green-energy water-autonomous greenhouse system 1, the internal temperature may increase and the potential energy difference between the plant 162 and the vegetation media 161 (e.g., soil) in the plantation trough 16 causes water molecules to evaporate and rise up to the top, and the air circulation can be enhanced with the ventilation device, such that the wet, warm air can be continuously heated and humidified in order to ascend thereby achieving a plant ecological environment system capable of autonomous circulations by means of this continuous circulation process.

To further describe the contents of the present invention in details, a diagram for an embodiment according to the present invention is herein proposed. As shown in Figure (5), the green-energy water-autonomous greenhouse system 1 can be directly installed in suspension outside of a building 3 such that the green-energy water-autonomous greenhouse system 1 can serve for the purposes of heat insulation, sound insulation, air-filtering of the building 3, landscape effects or an illumination box.

3.1.5 Brief description of the drawings

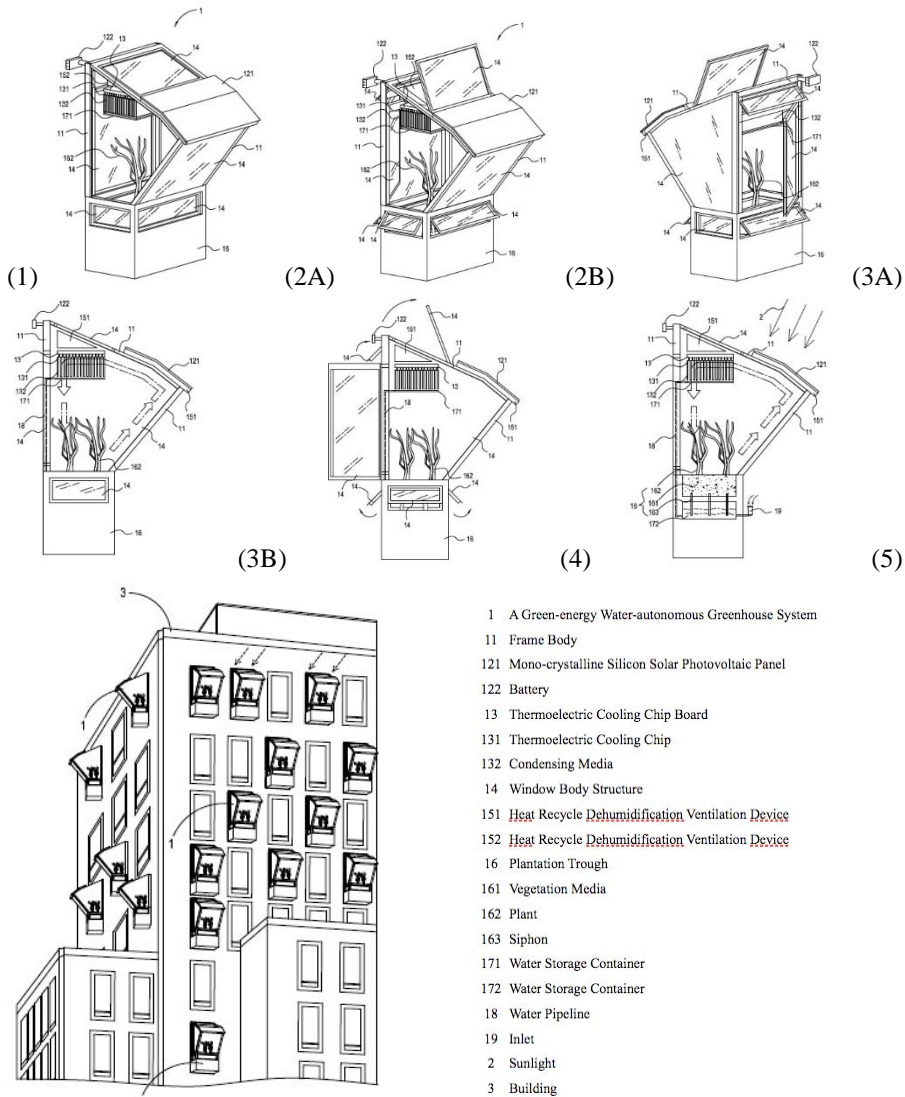

Figure 1. Drawings and Major Component Symbol Description

Figure 1 shows the drawings and major component symbol descriptions include a stereo combinatorial structure view, a front stereo view, a rear stereo view, two lateral views, an operation diagram, and an embodiment diagram for a green-energy water-autonomous greenhouse system according to the present invention.

4. DISCUSSION

4.1 Innovations

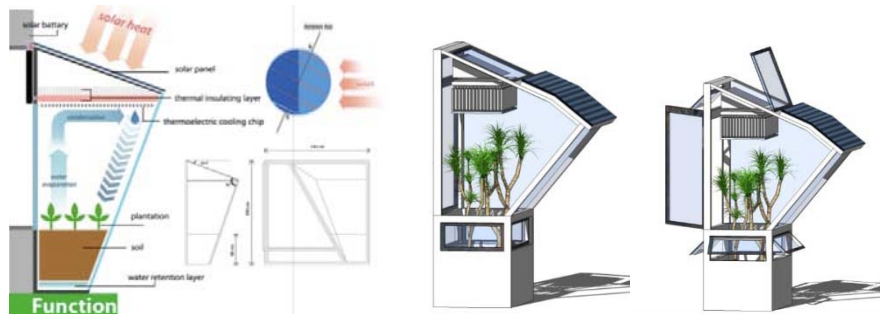

Figure 2. Innovations in system

Innovations in the presented prototype of green-energy water-autonomous greenhouse system are pointed out as follows:

1. A system is a set of things interconnected in such a way that they produce their own pattern of behavior over time. The system may be buffeted, constricted, triggered, or driven by outside forces. But the system's response to these forces is characteristic of itself, and that response is seldom simple in the real world. A system is more than the sum of its parts, it may exhibit adaptive, dynamic, goal-seeking, self-preserving, and sometimes evolutionary behavior (Meadows, D. H. (2008).). Just like the system defined above, the green-energy water-autonomous greenhouse system (named GEWA), showed as Figure 2., is an interconnected set of elements that is coherently organized in a way that achieves an adaptive eco-environment .

2. GEWA enhance a sophisticated and multidisciplinary approaches and technologies mentioned in most of reviewing research subjects to achieve an adaptive semi-closed climate-responsive pasive greenhouse system with rational using of water, efficient solar energy generation and usage, and mainly full natural ventilation, and capable of having required automatic adaptation for greenhouse control

3. The key point of system's characteristic functioning is the using of a thermoelectric cooling chip board on the bases of Peltire effect which make it possible that the evaporation and condensation processes and autonomous supply of water with a smale water cycle could be completed inside the greenhouse, and an water-autonomous greenhouse could be accomplished.

4. The integrated mechanism applied in system also include: (1) evaporatranspiration of plants and growing substances, (2) photosynthesis

of the plants, (3) photovoltaic effect of the solar power system, (4) purification of water, (5) integrating networking solutions of the system which converges green and intelligent technology to improve responsiveness, efficiency, and performance, (6) photocatalysis on surface of greenhouse structure and materials, equipments and devices, (7) fuzzy control strategy for window system, (8) photoelectrochromic effect of window glass.

4.2 Advantages

Compared with other conventional application technologies, the green-energy water-autonomous greenhouse system provided by the present invention further offers the following advantages:

1. The present prototype provides a green-energy water-autonomous greenhouse system and automatically provides electric power for its internal operations by means of the solar power generation device such that a plant ecological environment system similar to a greenhouse can be maintained within the green-energy water-autonomous greenhouse system.
2. The window body structure of the present prototype facing indoors can be opened to supply the generated oxygen into the room thereby attaining the purposes of green environment and beautification effect at the same, and the people within the room can also enjoy the delightful landscape.
3. The installation of the present prototype extends outwards from a window, which does not occupy too much indoor space and very convenient for arrangements; meanwhile, such an outside-window installation can be helpful for adding suitable ornamental plants or alternatively practicing edible plant vegetations to act as a small-sized vegetation farm.
4. An electronic supervisory system can be externally connected to the present prototype so that environmental variations within the green-energy water-autonomous greenhouse system can be monitored remotely and components inside the green-energy water-autonomous greenhouse system can be controlled so as to suitably regulate such environmental change factors thereby maintaining the optimal growth environment for plants.

4.3 Incorporating greenery into building

A GEWA, as an eco-environment, could incorporating a variety of greenery into buildings on the walls and openings, it could be a window

garden, be a conservatory, be an experimental platform, be a climate station, be a cloud point in smart city, and indeed be a third environment inbetween the outside and inside building environment.

As a third environment, GEWA could be more adaptive than conventional vertical greening by an additional function of mitigating environmental impact to a building .

An example is described by a CFD simulation to investigate the influence of GEWA on the wind flow from the outside to the inside of the building. As showed in Figure.3, an wind flow with average wind speed of 2.43m/s at SW wind direction was simulated, figure. a~c show a CFD model and the grid pattern, figure.d shows windflow section at Range:0~3m/s, figure.e shows windspeed distribution at 1.5m high at Range:0~3m/s, figure.f shows windspeed equalizer surface at windspeed 1m/s. From the results of analysis, the windflow pattern could be realized and the effects on the environment could be evaluated.

Other environmental factors and parameters like temperature and humidity also could be simulated.

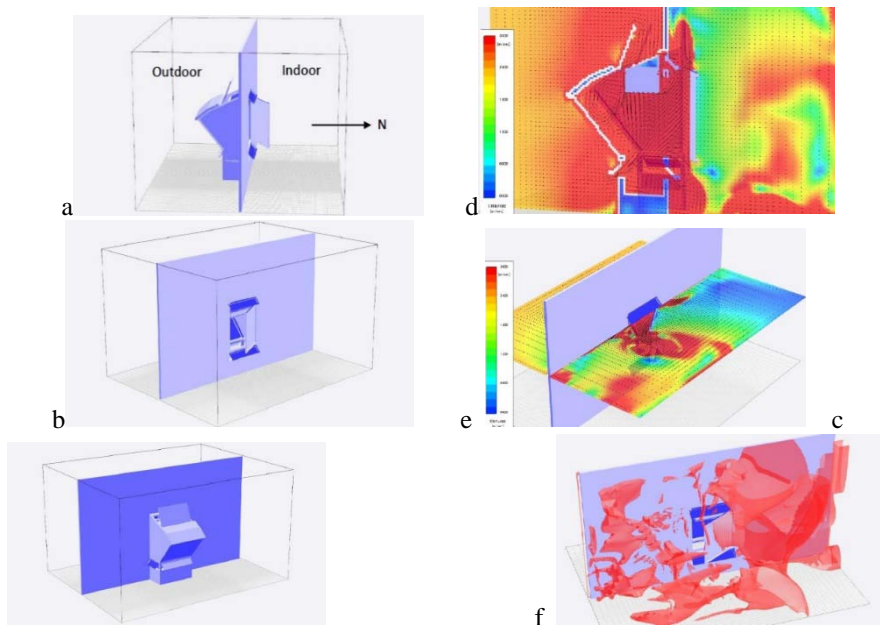

Figure 3. CFD environmental simulations of wind flow through greenhouse (simulated by WindperfectDX, total numbers of grid point are 2,753,520)

It is expected to use GEWA to incorporate greenery into building as an alternative of vertical greening to open a very interesting possibility for increasing attractiveness of cityscape and to enhance progressive urban revitalization in smart city. An example is shown as Figure.4.



Figure 4. Incorporating greenery into building, before and after.

5. CONCLUSION AND RECOMMENDATION

5.1 Conclusion

I

From the saying by Parakramabahu the Great, King of Sri Lanka, 1153-1186, the Motto of Water Tribune Conference in EXPO Zaragoza 2008 - “Not a single drop of rain-water must be allowed to go to the sea without first being of service to people”- announced the most importance of efficient usage of water and water saving for us to overcome the growing drought and water scarcity in the world.

Green technologies of efficient natural solar energy usage , include energy generation and energy retention, are also most important for humankind to “going greener” and ”getting smarter” naturally and wisely.

A sophisticated and multi-disciplinary green-energy water-autonomous greenhouse system, by using the water resource and solar energy in a rational way, could be an alternative-technology approach towards a sustainable smart-green vertical greening in smart city.

5.2 Recommendation

It is suggested that follow-up studies be conducted in the following areas.

1. A real model of the prototype should be established to conduct relevant experimental study and to contribute to build big data for research.

2. Research studies should be continued to search for a more progressive GEWA by enriching qualities of design from variety, leaps of imagination in materials and form, sheer elegance of craft and composition, and mind-sparkling ideas for increasing attractiveness of cityscape and to enhance progressive urban revitalization in smart city.
3. For a more progressive GEWA, aspects like energy efficiency, water saving, construction methods, performance of materials and smart devices, system mechanism, environmental benefits and economics must be further examined.

REFERENCES

- Abdel-Ghany, A.M., Al-Helal, I.M. (2011). "Solar energy utilization by a greenhouse: General relation", *Renewable Energy*, 36, 189-196.
- Attmann, O. (2010). *Green Architecture: Advanced Technologies and Materials*. New York: McGraw-Hill Education.
- Baeza, E.J., Perez Parra, J., et al. (2009). "Analysis of the role of sidewall vents on buoyancy-driven natural ventilation in parral-type greenhouses with and without insect screens using computational fluid dynamics", *Biosystems engineering*, 104, 86-96.
- Bakker, J.C., Adams, S.R., et al. (2008) "Innovative technologies for an efficient use of energy", *Acta Horticulture*, Volume 801 Part 1, 49-62.
- Balas, M. M. (2014). "Seven passive greenhouse synergies", *Acta Polytechnica*, Volume 11, 199-210.
- Buchholz, M., Buchholz, R., et al. (2006). "Temperature and humidity control in the watery greenhouse", *Acta Horticulture*, Volume 719, 401-407.
- Buchholz, M., Schmidt, M., et al. (2008). *Overcoming Drought*. Implementation guide of the "Cycler Support" project, RTD FP 6-INCO. Ref. Nr. 031697.
- Buchholz, M., Zaragoza, G., et al. (2004). "Thermal control of an isolated greenhouse for optimized food production and greywater recycling: The watery project", *International Astronautical Federation-55th International Astronautical congress 2004*, Volume 3, 1681-1688.
- Giacomelli, G. (2007). "Innovation in greenhouse engineering for Greensys2007", *New ag international*, Greensys pages at www.newaginternational.com.
- Hatzelhoff, L., Humboldt, K., et al. (2012). *Smart City in Practice*. Berlin: jovis Verlag GmbH.
- Hemming, S., Speetjens, S. L., et al. (2014). "Greenhouse design for vegetable production in subtropical climate in Taiwan", *Acta Horticulture*, Volume 1037, 65-74.
- Jochum, P., Buchholz, M. (2005). "How to simulate thermal and fluid dynamical processes in closed greenhouses including water interactions between plants and air", *Acta Horticulture*, Volume 691, 553-560.
- Katsoulas, N., Sapounas, A., et al. (2015). "Reducing ventilation requirements in semi-closed greenhouses increases water use efficiency", *Agricultural Water Management*, 156, 90-99.
- Kwok, A.G., Grondzik, W.T. (2011). *The Green Studio Handbook*. New York: Taylor & Francis.

- Lamnatou, C., Chemisana, D. (2013). "Solar radiation manipulations and their role in greenhouse claddings: Fluorescent solar concentrators, photosensitive and other materials", *Renewable and Sustainable Energy Reviews*, 27, 175-190.
- Meadows, D. H. (2008). *Thinking in systems-A Primer*-. The United States of America: Chelsea Green Publishing.
- Montero, J. I., Van Henten, E. J., et al. (2011). "Greenhouse engineering: New technologies and approaches", *Acta Horticulture*, Volume 893, 51-64.
- Opdam, J. J. G., Schoonderbeek, G. G., et al. (2005). "Closed greenhouse: A starting point for sustainable entrepreneurship in horticulture", *Acta Horticulture*, Volume 691, 517-524.
- Orgaz, F., Fernandez, M.D., et al. (2005). "Evapotranspiration of horticultural crops in an unheated plastic greenhouse", *Agricultural Water Management*, 72, 81-96.
- Peng, K.H., Kuo, Y.C., et al. (2015). "The use of Vertical Greening in Urban Rehabilitation to Improve Sustainability of the Environment in Taiwan", *International review for spatial planning and sustainable development*, Vol.3 No.1, 5-16.
- Perez Parra, J., Baeza, E., et al. (2004). "Natural Ventilation of Parral Greenhouses", *Biosystems engineering*, 87(3), 355-366.
- Speetjens, B., Xu, J., et al. (2006). "A model for the climate of an innovative closed greenhouse for model based control", *Acta Horticulture*, Volume 718, 323-330.
- Speetjens, S.L., Stigter, J.D., et al. (2009). "Towards an adaptive model for greenhouse control", *Computers and Electronics in Agriculture*, 67, 1-8.
- Speetjens, S.L., Stigter, J.D., et al. (2010). "Physics-based model for a water-saving greenhouse", *Biosystems engineering*, 105, 149-159.
- Tantau, H. J., Schmidt, U., et al. (2011). "Low energy greenhouse- A system approach", *Acta Horticulture*, Volume 893, 75-84.
- Teitel, M., Baeza, E. J., et al. (2012). "Greenhouse design: Concepts and trends", *Acta Horticulture*, Volume 952, 605-620.
- Teitel, M., Ziskind, G., et al. (2008). "Effect of wind direction on greenhouse ventilation rate, airflow patterns and temperature distributions", *Biosystems engineering*, 101, 351-369.
- Vadiee, A., Martin, V. (2012). "Energy management in horticulture applications through the closed greenhouse concept, state of the art", *Renewable and Sustainable Energy Reviews*, 16, 5087-5100.
- Vadiee, A., Martin, V. (2013). "Thermal energy storage strategies for effective closed greenhouse design", *Applied Energy*, 109, 337-343.
- Vale, B., Vale, R. (2000). *The New Autonomous House: Design and Planning for Sustainability*. United Kingdom: Thames & Hudson Ltd.
- Van Kooten, O., Heuvelink, E., et al. (2008). "New developments in greenhouse technology can mitigate the water shortage problem of the 21st century", *Acta Horticulture*, Volume 767, 45-52.
- Zaragoza, G., Baeza, E., et al. (2005). "The Watery Greenhouse: A Closed system for Solar Thermal Energy Collection, Water Treatment and Advanced Horticulture", *SAE International Conference On Environmental Systems*, Paper #: 2005-01-2919 .
- Zaragoza, G., Buchholz, M., et al. (2007). "Watery project: Towards a rational use of water in greenhouse agriculture and sustainable architecture", *Desalination*, 211, 296-303.
- Zaragoza, G., Buchholz, M. (2008). "Closed greenhouses for semi-arid climates: Critical discussion following the results of the Watery prototype", *Acta Horticulture*, Volume 797, 37-42.



NO.91

The Conflict Around the Military Brownfield Project in the Canadian Capital

Tension between Local and Global Conceptions of Sustainable Urban Development

Kenza Benali^{1*}

1 University of Ottawa

** Corresponding Author, Email: kbenali@uottawa.ca*

Key words: Smart growth , military brownfield reconversion , sustainable neighbourhoods , Canada's Capital , urban conflict , global/local tension

Abstract: Brownfield redevelopment - rehabilitation of the underutilized, derelict or vacant properties and sites- is recognized today like one of the best forms of sustainable development. Over the past decade, a number of remarkable projects in urban brownfield reconversion emerged across Canada, including the reconversion of inner-city former military bases owned by the Canada Lands Company (CLC) into sustainable neighbourhoods. However, unlike other developments, the regeneration project of the military base Rockcliffe in Ottawa – which was announced as one of the most ambitious Smart growth projects in Canada – faced serious obstacles in terms of social acceptance by the local community, particularly urban minorities composed of Francophones, Indigenous and vulnerable groups who live near or on the Base. This turn of events led to the project being postponed and even reconsidered. Through an analysis of its press coverage, this research aims to understand the causes of this urban conflict which lasted for nearly ten years. The findings reveal that the conflict is not limited to the “standard” issues common to most conflicts related to urban mega-projects in the world – e.g., proximity issues (threads to the quality of the surrounding neighbourhoods; noise, traffic, pollution, New-build gentrification) often associated with NIMBY phenomena. In this case, the local actors questioned the purpose of the project (for whom and for what types of uses is it conceived?), its local implementation (to what extent are the local history and existing environment taken into account?), and the degree of implication of the local population in the decision-making process (with whom is the project built?). Moreover, the interests of the local actors have “jumped scales” and transcend the micro-territorial level of their daily life to take on a national and even international dimension. They defined an alternative view of how this project, considered strategic by his location in the nation’s capital, should be a reference as well as an international showcase of Canadian

Environmental Planning & Green Building

ambition and achievement in terms of urban sustainability. This vision promoted, actually, a territorial and national identity approach - in which some cultural values are highly significant (respect of social justice, inclusivity, ethnical diversity, historic/cultural heritage, etc.)- as a counterweight to planners' vision which is criticized as a normative/global logic that ignore the territorial peculiarities.



NO.99

A Research on Community Construction and Characteristic Shaping in Town *The Case of Xiao-Chi of Hubei*

Zhi-Yong Wang¹, Yang Liu^{1*}, Yan-Fei Jia¹, and Shu-Xian Wang¹

1 School of Architecture and Urban Planning, Huazhong University of Science and Technology

** Corresponding Author, Email: wzhyvng@gmail.com ; 470014462@qq.com ;
yanfeijia@hotmail.com ; wsx523@qq.com*

Key words: Urban communities, characteristic shaping, problems, countermeasure

Abstract: Against a background of rapid development of urbanization, it becomes common that small towns are lack of typical characteristic and urban communities are lack of humane care. Taking the case of Xiao Chi of Hubei, this paper discusses the values of urban communities, and proposed five elements of urban communities including society, space, organization, life and culture. This paper proposes problems about characteristics creating in urban community and studies the countermeasure of shaping characteristic on nature, location, humanities and other aspects.

1. BACKGROUND

Small town is the headquarter of the rural area but the tip of the city, and its construction and development are the key point of the process of new type urbanization and unification of town and country. Since reforming and opening, the development of urban and rural, both in terms of size and speed, is historically unprecedented. With the acceleration of urbanization, there has emerged many problems during the last decade, such as industrial pollution, disorder growth of urban land and incompact structure. Besides, the disappearance of characteristics in towns have attracted great deal of attention. Those problems, such as the cities now are the same and lack of features, have been frequently criticized by professions. Features of towns, as carrier of the spirit, are important for towns to survive and develop. As the original power to develop the towns, characteristics not only contribute to improve the competitiveness but also realize the regional value, cultural value and emotional value of towns. Shaping characteristics of towns is to improve core-competitiveness, to build a high-level and harmonious living

environment and realize new urbanization.

As orientation of solving social conflicts, communities have received more and more attentions by the whole society. Improving urbanization level, converting rural population locally, communities constructing plays key roles. Communities are also being the windows to show urban resources and regional cultures. In the fast development of urban construction, however, we always ignore to construct characteristics of communities, thus lead to single appearances, obsolete infrastructures, deteriorate environments and lack of cultures and etc.

This paper takes the case of Xiao Chi of Hubei to study communities construction, and characteristics constructing.

2. THE RECOGNITION OF COMMUNITIES IN TOWNS

2.1 The Connotation of Town Communities

Community is a basic concept in sociology, first proposed by Ferdinand Tennes, a German sociologist, who defined community as a social group which is composed by homogeneous people with a close relationship and are willing to help each other, and therefore, community is a unit with full of humanity. Different scholars have various definitions about modern community from different perspectives, some people view community as a social group which is composed by homogeneous people who share the same sense of values, have a close relationship, and are willing to help each other. Others think community is a social integration which is composed by the people who are living in a certain region. In my opinion, community is a social integration composing of social groups who are living in a certain area, people engage in a variety of occupations. The main difference between urban residential community and urban residential district is that urban residential district is residential district per se, while urban residential community composes core function of living, around which forming social communication net, hence the urban residential community is more profound and wider than urban residential district.

Town is the bridge and link that connects the city and village, it not only has a close relationship with the countryside, but also is influenced greatly with metropolises by economic, commerce and technology. Correspondingly, in the sociological community study, the word resembles to small towns but different in coverage area is 'Rurban', in Chinese means market town. This word was raised by Gaylep, a sociological professor in University of Wisconsin, he explained that 'Rurban' is a coalition of rural and urban, it stresses the intermediate of urban communities-evolving from

rural communities and serving rural, but having the characteristics like urban.

Although, communities in small towns have the same function in connecting rural and urban comparing with the 'urban' communities, the former is bigger than the latter. As it were, communities in small towns are transitional communities that have the characteristics of both urban communities and rural communities.

2.2 The constitutions of town communities

As a social substance, communities content basic elements: firstly, a certain size and scale inhabitants with homogeneous social life linked by a production and other social relations; secondly, a district has boundary-people can live in and make social activities at here; thirdly, a set of service facilities that provide people the basic material needs and spiritual needs; fourthly, an administration that matches with the institution of living; lastly, based on the community economic, social developments and historical traditions, people have sense of identity and belonging to community in emotion and mental.

2.3 The basic properties of Town community

2.3.1 Societal property

The relationship of human is the nature of society, thus community is consisted of human and its interrelation. But community is smaller than the society, as a part of the society. The population of community is a part of the whole society and its region and sundry facilities are parts of social conditions , their regulatory agency belongs to the whole social administrative system, the whole society is consisted of several different kinds of communities. Moreover, a community also includes varied social relationships, varied social groups and social organizations, varied social activities, just likes a "small society".

2.3.2 Spatial property

Community is a small society that contains a certain specific space, and it's a combination that the group living in a certain space, the community space is smaller than social space and it's a constituent part of social space. "When it comes to community, I mean whichever common living area:

village, town, district and even bigger region,”says Mcllwain, a British sociologist, who had pointed out in his book *Community: Sociological study*, published in 1917. Community is a society that composed by the unit of families and neighborhoods-space continuum.

2.2.3 Organizational property

A group living in a certain space isn't a collection of atomized but organized. Although living in a space, the group that is in organization can't form a community, it calls inn at most. Human social organization can be divided into 5 categories: political organization (e.g. political party and army) , administrative organization (e.g. government) , economical organization (e.g. the enterprises that for the purpose of profit) , non-profit making organization (e.g. school, church and caring organization), social organization (e.g. human community and village).

2.2.4 Living property

The meaning of community is the lives of residents, and it's different from industrial area, commercial district, tourist area, school and business area. A residential community may contain multiple regional elements, but the basis of residential community is life, the standard to class communities is life.

2.2.5 Cultural property

Different countries have different cultures, the same as different regions and different cities, so different residential communities also have them own cultures-people live together for a long time will arise characteristic community culture, and those cultures show a homogeneity of different ideas and behaviors. As an old saying goes: a far-off relative is not as helpful as a near neighbor, it's a reaction of community culture. “All over the world, if only people live together, they will develop common but different characteristics-custom, tradition and life style,” says Mcllwain.

3. CURRENT PROBLEMS OF CHARACTERISTIC OF URBAN COMMUNITY

3.1 The spiritual and traditional cultures neglect of community

The construction of urban community pays attention to entity space, leading to the neglect of spiritual connotations of community and the insufficiency of regional culture resources. Without building the relationship between people, the common sense of worth will not be established. Small towns have abundant human resources, the national cultures, folk cultures and religious cultures blend here and co-exist harmoniously, but lack a deeper study. The fracture and lag of cultures, leading the erectors and residents who live in the town are skeptical to traditional cultures. Xiao Chi has Miaole temple which are called for “South China first Temple”, and it contains a variety of traditional cultures such as Huang Mei Xi, Ying Couplet (a couplet written on scroll), cross-stitch work , WuShu and so on, but those human resources are not developed adequately in community construction.

3.2 The Deficiency of Characteristics and Local Styles in Community

With an acceleration of urbanization, the characteristics of urban are muddledness and hiatus and the space of communities are disorganized or monotonous. The reasons for causing the communities cast in the same mold are that the space in communities are lacking of characteristics, identifiability and landmark. The community in Xiao Chi’s old town has many problems: construction features are single, facilities are obsolete, environment is deterioration and the whole town is lack of planning and operation .

3.3 Superior location but unused regional culture

As the door of Hubei province, Xiao Chi fails to show the features of portal town. In the first place, as a window located in the east of Hubei, its characteristics of regional cultures can be synthetically showed, for example, the Red and Green cultures in eastern Hubei, the characteristics in Jiangnan plain of mid Huibei and the rural cultures of minority nationality in western Hubei. Secondly, as a cross point of Huibei, Jiangxi and Anhui, the cultures of those three should be showed synthetically, according to

display the cross-regional cultures of building in Jiangxi and Anhui, the regional cultural characteristics of Xiaochi can be showed.

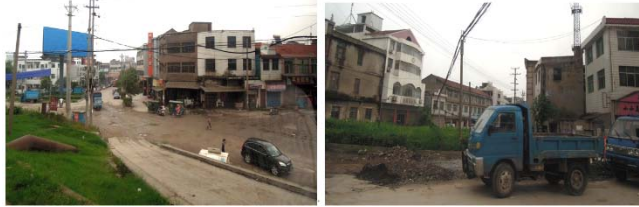

Fig.1 Community Construction appearance of Xiaochi

4. THE STRATEGIES TO SHAPE THE CHARACTERISTICS

XiaoChi, located in Huibei Huangmei County, was a vital frontier fortress in history due to its convenient traffic—it was on the borders between the two kingdoms Wu and Chu. In the new epoch, Xiaochi is the junction of Hubei, Jiangxi and Anhui, the Yangtze River and Beijing-Kowloon Line also intersect at here. Besides, in the mid-delta area, it is the point to link Hubei and Jiangxi, the economic circle of East and Huazhong, the junction of Wu Han, Anhui and Po Yang Lake economic circles. New Riverside District in Xiaochi has been promoted to provincial strategy and it aimed to develop a demonstration plot in Yangtze River area, an experiment plot of interregional economic cooperation, a model area of new urbanization in central region and a showcase to reveal the characteristics of new towns in Hubei.

Among the rest, as a crucial part in shaping the characteristics of urban communities, constructing and developing the characteristics of urban have significant meanings. The sufficient developments and progresses contribute to the development of urban, but making an urban construction without developing communities may lead to an unstable and ungrounded situation. For shaping the characteristics of urban communities, the countermeasures are as follows.

4.1 Humanistic Charm and historical culture Developing

During the long historical period, the historical humane factors had been accumulated, as a precious treasure of the cities, they reflect the characteristics and features of cities. The integration of historical humane factors and urban spatial environments contribute to a wider influence and attraction of urban. We can see the original point from the urban evolution,

the colorful historical culture and distinctive folk custom, and to inherit and develop the urban cultures, providing a basis to shape the urban traditional characteristics in the end. The communities include cultural relics or says cultural relics are communities themselves, just like communities in Nanjing and the Summer Palace. The characteristics like those can show the urban regional cultures directly, they can be the carriers to inherit the regional traditional cultures. To write the history, it's necessary to evaluate the factors of communities and delimit protection domain.



Fig.2 New Riverside District Planning in Xiaochi

As the living space of human, community environments are the rallying and inheritable points of community cultures. Therefore, when shaping the environments of communities, we must recognize the importance of cultural characteristics in order to improve the health and cultivate the noble sentiments of residents. When shaping the cultural atmospheres of community environments, it should attaches importance to the characteristics of regional natural environments and local architectures and landscapes, to find and extract the historical cultural traditional of communities. Besides, making community environmental cultures plentiful, continuous and multiple can increase the cultural tastes and characteristics of community environments.

As the headstream of Mei Diao and Ying Couplet, Xiao Chi has long histories of religion, traditional opera and customs. We should take advantage of Miao Le Temple, Qing River, historical ancient towns, the historical ferry culture, religionary cultures and so on to construct the Miao Le area and Qing River towns, to mold a town have the characteristics of religion, and constructing and developing the historical traditional.



Fig.3 Miao Le Temple area

4.2 Eco-community construction with mountain and water feature

The natural environmental element is a vital factor that reflects the urban characteristics and spatial environmental features. Communities can take the advantages of the differentiae with other districts and particular ecological environment to show its characteristics, original natural condition is a vital part to increase the identification of the communities. The first step to shape the characteristics of a community is to find its natural connotations and analyze the natural environmental factors. The communities, whether in the plain or in the mountain, whether on the sea, on the river or around the lake, if only it respects the structures and factions of the city, the original terrain and physiognomy should be obeyed. Besides, the lakes, mountains and green resources should be valued. In fact, nature is distinctive, the original terrain and physiognomy are important factors to increase identifications. To our artificial communities, it's better to be as wonderful as nature.

It's necessary to analyze and evaluate the topography of mountains, lakes and vegetation species, by analyzing the spatial environmental characteristics of mountain, water and green system to evaluate the development potential. It's important to respect and protect nature and strengthen natural features, by shaping the characteristics can promote the quality of environments and modern living conditions for community and even the whole city. Carding the hydrographic net and green net, for example, east connects Fan Shui Pool and west links Guan Hu Port, and then taking the advantages of natural river system to card hydrographic net. Connecting the hydrographic and roads to build urban parks and green belt, constituting the urban green net and shaping an ecological community with the characteristics of mountain and water .

4.2.1 A water-feature town



Fig.4 New Riverside District Planning in Xiaochi

By using the natural water to link the water system and make water streets. Using East Port, GuanHu Port and West Port to hackle the water system, making a water net that across the center of city. Building streets depend on water, making an integration of water and street.

4.2.2 A riverside town

Forming a riverside landscape pattern which includes a wetland park, a landscape belt and an urban outline, making a riverside town. Putting the



Fig.5 Riverside District & water-feature town

ecological greening as the main body to build a riverside green landscape belt; limiting the riverside vertical outline to build the outline of the town.

4.3 Local context-feature community construction

Each town which has its own unique geographical advantages and resources should be made full use of its geographic location, transportation, mining, energy and policy condition advantages, which in turn should be deeply dug, comprehensively analyzed and systematically integrated to extract a town features. That would sufficiently guide urban economy, social and environmental resources to a sustainable development. Shaping the community features should fully take the characteristics of the geographical and the socio-cultural of its regional into consideration, which would be used of in the image of landscape design to form a geographical landscape image features of a residential community. It settled on a specific region, its geographical and cultural characteristics should be reflected in some of the landscape image, which is both a respect for the local environment and culture, but also a origin of the features to create a community environment.

Riverside District of Xiao Chi will become a "throat center, east portal, image window" in Hubei Province under the new era. Xiao Chi should be an open window in Hubei as a core development area of the border region of Hubei, Jiangxi and Anhui provinces. Urban construction should reflect the unique nature, culture and diversity, which focus on showing the town features of different regions in Hubei.

Combining the portal status in three provinces, four district centers and the location advantages in border towns to create a typical geographical features of Hubei . The Riverside District of Xiao Chi is built a window to show the regional style in Hubei, reflect the characteristics of different regions in terms of urban space, architectural style, environment, etc. Creating some theme plate images, such as, "Water town in Jiangnan, style town in western Hubei, style town of Dabie Mountain, style town in Jiang Xi and An Hui " to show regional styles, attract people gathered and the geographical characteristics of urban style community .

4.3.1 Jiangnan River-feature town

Combined with the characteristics of the water network to build an integrated commercial and residential riverside urban community, showing the features of water of Jiang Han Plain region in Hubei.



Fig.6 Jiangnan River-feature town

4.3.2 Hubei west feature town

Reflecting the local residential characteristics of western Hubei on architectural designing, showing the unique geographical features of hills and mountains on space creating, manifesting the culture and customs of the minority areas of Tujia on culture, thus constructing the urban communities have the characteristics of western Hubei.



Fig.7 Hubei west feature town

4.3.3 Dabie Mountain feature town

Surrounding the "double color" theme of red and green cultures of Dabie Mountain to display the mountainous architectural and cultural features in eastern Hubei, to create the urban communities have the characteristics of Dabie Mountain .



Fig.8 Dabie Mountain feature town

4.3.4 Jiangxi and Anhui feature town

To show the geography that XiaoChi is located in the joint of Hubei, Jiangxi and Anhui, shaping the view of Jiangxi and Anhui's architectures and the urban characteristics of border cities, to building the urban communities have the characteristics of Jiang Xi and An Hui.



Fig.9 Jiangxi and Anhui feature town

5. SUMMARY

The characteristics of urban have significance to improve the core competitiveness, make a harmonious living condition and achieve new urbanization. Therefore, when developing the small towns, it's important to take advantages of regional resources and cultural characteristics to shape the features of communities. Communities that have humanistic care contributes to the development of urban.

REFERENCES

- XIAO Yong LI Zhaofen. Practical Exploration of Protection of Historical and Cultural Block[J]. Chinese and Overseas Architecture , 2009 (11)
- HE YI; LI Jinsheng. Urban Renewal under a Post modernism Perspective[J]. Urban Planning Forum , 2008 (2)
- XIA Qing Residential community identifiability research—Based On CIS[D]. The Dissertation for Master Degree of Nanjing Forestry University,2009
- RUAN Yisan,SHAO Yong,LIN Lin. The Characteristics,Values and the Preservation Planning of the Towns in Jiangnan Water Region. Urban Planning Forum[J]. 2002(1): 1-3.
- ZHU Ying. Typology Method in Historic Block Protection. Urban Planning Forum , 2002 (6)
- ZHAO Hai-bo. On the protection of the historical streets and the development measures in the urban renewal. Shanxi Architecture , 2009 (1)



NO.103

Landscape Management for Multifunctional Urban Green Space

Approaches for Community Involvement in Management of Urban Green Space

Wenzheng Shi^{1*}

1 Shanxi Academy of Urban & Rural Planning and Design

** Corresponding Author, Email: tdjtzz@msn.com*

Key words: Landscape management, community involvement, green infrastructure, multifunctionality.

Abstract: Landscape management planning plays a key role to improve quality of urban environment and help to encourage community involvement. Urban environment issues have been recognized by public. Its planning and design also considered by professionals. However, most of researchers emphasised spatial planning as a basis for developing green infrastructure to promote new strategic connections in urban green space and ignore the impact of management. Landscape management is not simply as physical maintenance, but also importantly related to social, cultural and economic issues. In this case, promoting community involvement provides opportunities to achieve management vision and benefits during in management process. This paper argues that if local authorities aim to achieve multifunctional urban green space in planning and practices, they must make effective and effectual management and also have to improve community involvement in management. This is not simply to ask people involved in using of urban green space, but also important to provide policies for encouraging community involvement in urban green space management. In this paper, a case study will present experiences of community involvement in Sheffield in UK. This study is benefit to learn the experience of landscape management planning from Sheffield which has rich management practices of green and open spaces. Sheffield's Green and Open Space Strategy (GOSS) has been developed for managing green and open spaces in Sheffield. It will show how community involvement is considered to improve quality of multifunctional urban green space by local authorities and promoted in local planning and policy. As a result, a framework of landscape management will explored to promoting community involvement from this study. It also attempts to provide a primer for community involvement which could be promoted in Chinese cities.

1. INTRODUCTION

Landscape management plays a key role in improving the quality of urban environment and enhancing multifunctionality in green infrastructure. It works to guide the efficient and effective management of green spaces for sustainability, health and wellbeing. However, most approaches to developing green infrastructure usually emphasize spatial planning aspects, and give less attention to landscape management aspects. Landscape management, as way of achieving long-term vision, is closely related to planning and design to promote quality of green and open spaces. It has been practiced at scales from individual parks to large green spaces, from single sites to multiple broad areas.

As management approach, good quality green spaces in urban areas provide opportunities for voluntary and community activities. They provide the chance for people to participate in the process of design, management and care of their local space. Involving communities is recognised as a fundamental part in the process of planning, design and management. According to landscape management approach, community involvement benefits to bring many social benefits and to enhance the quality and multifunctional use of green spaces. It is important for urban development and for curing environment issues in our cities. However, in China, the understanding of landscape management is usually emphasized on physical condition with quantity and given less attention on their function values which have potentials for social values.

In this context, this paper studied how landscape management promotes community involvement for multifunctional urban green spaces from Sheffield management experiences. This study is benefit to learn the experience of management planning which has rich management practices of green and open spaces. It also investigated how to promote community involvement in policy for enhancing multifunctional green space in landscape management.

2. LANDSCAPE MANAGEMENT AND COMMUNITY INVOLVEMENT

2.1 Green infrastructure in urban environment

The idea of green infrastructure is now recognised as a popular term in planning and management of landscape. It is not a new idea and has been developed from urban green spaces; it can provide sustainable development in urban areas with multifunctionality, now and into the future (CIWEM 2010). Urban green space as a basic notion of landscape plays a key role in

green infrastructure to maintain sustainable development and quality of life. Urban green space is defined as all publicly owned and publicly accessible open space with a high degree of cover by vegetation such as parks, woodlands and other green spaces (Sandström 2009). Urban green spaces play a vital role for improving quality of life and benefits for urban environment issues. It is developed and managed by practitioners and is recognised as an essential factor in urban environments. Moreover, urban green spaces help to make cities more attractive to live in and provide opportunities for people to relax, exercise, play sports and meet friends (ODPM 2006).

As an influential notion, green infrastructure has been recognised widely in regions of Europe, UK, USA and Asia. For instance, in England, the government published the National Planning Policy Framework (NPPF) in 2012 to replace most of the preceding planning guidance (DCLG, 2012). The political vision positively endorses the role of the planning process for the creation, protection, enhancement and management of green infrastructure in UK (DCLG2012). In China, green infrastructure is recognised by researchers as being important in landscape development, providing multiple services and benefits. Some researchers gained experience from America, Australia, Europe and UK to define a concept of green infrastructure (Li 2009; Wu and Fu 2009). However, practitioners prefer to refer to the green space system rather than to green infrastructure in China. Especially in the planning stages, the green space system plan, as part of the statutory planning process is generally practiced in most cities in China.

As a core aspect of green infrastructure, the concept of multifunctionality has been considered in landscape research and has had particular impact in Europe. The concept of landscape multifunctionality has organically developed from agricultural landscapes in the countryside and has been broadly considered from urban green spaces, the urban fringe and the countryside (Ferrari and Rambonilaza 2008; Fry 2001; Groenfeldt 2006; Naveh 2001). It has defined landscape multifunctionality as containing historical functions, ecological functions, communitarian functions, economic functions and aesthetic functions (Ling et al. 2007). In this condition, multifunctionality for green infrastructure has been considered within planning, design and management processes to ensure that spatially targeting achieves optimum gains for social, environmental and economic development.

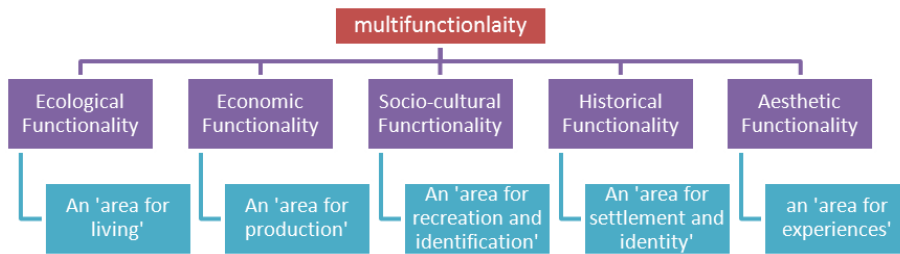

Figure 1. Five key landscape functions in multifunctionality (Adapted from: Brandt et al. 2000; Ling et al. 2007; Selman and Knight 2006)

The CLERE model has been offered as a management tool to improve multifunctionality in the process of landscape management (Barber 2005). The CLERE model offers an important expression of multifunctionality and aims to improve this through management. It integrates multifunctionality in five broad functions, which are Community, Landscape, Ecology, Recreation and Economy (Table 1). This model offers a suitable construct to achieve improved management from the perspective of multifunctional approaches.

<p><i>Table 1: The 'CLERE' Model (Adapted from: Barber 2005)</i></p> <p>The 'CLERE' model for multifunctional urban green space:</p> <ul style="list-style-type: none"> - As an agent for 'Community' development and education - As 'Landscape' to be conserved - As an 'Ecosystem' providing urban services - As a 'Recreational' resource for health and wellbeing - As a contributor to the local 'Economy'

In general, green infrastructure as an integrated approach has extended the values of urban green spaces and has considered them as a network at different scales, which can be brought together for delivering multiple services and benefits, enhancing quality of natural environments and human wellbeing. In this process, multifunctionality has been recognised as the core notion of green infrastructure, providing a basis for a broad approach.

2.2 Landscape management for urban green space

Landscape management is used to the efficient and effective management of green space which includes urban and rural green spaces by the owners and managers (CABE 2005b). Landscape management, as way of achieving long-term vision, is closely related to planning and design to promote quality of green and open spaces. It has been practiced at scales from individual parks to large green spaces, from single sites to multiple broad areas. Unified management and daily maintenance together can

deliver good quality and efficient services.

Traditionally, management is developed from park management and transferred into green spaces from site level to city level. As a fundamental part of management, maintenance is considered as ground maintenance of sites, for example, cutting and tending grass, including re-turfing and reseeded, and tending trees, shrubs, hedges, flowers and other plants (Welch 1991). However, as a complex multi-faceted task, landscape management has a concern to ensure various benefits and achieve a long-term vision. Modern management might include more of a shift from physical to emotional properties, which are concerned with more than horticulture care. It could help managers to achieve their goals and ensure people get greater leisure enjoyment and benefit from green spaces.

Moreover, the CLERE model has been promoted to help managers and local authorities to identify skills shortages and define structures and management processes (Barber 2007). It considers all expert needs and concerted management for achieving optimum outcomes. The CLERE model helps to derive the key main tasks and performance measures which could support the vision of managing green space for multifunctional green infrastructure (Barber 2005).

Further the importance of management is to realise the potential of urban green spaces through management practices. Moreover, the process of management should also identify potential. If the potential of green spaces is not realised in the management process, then management practices could be sub-optimal and sometimes not develop the potential benefits overall (Levent and Nijkamp 2004).

2.3 Benefits of community involvement from landscape management

Community development is a key factor of urban green space management (CABE 2006; Sheffield City Council 2010). As described earlier, community involvement brings many social benefits to enhance the quality and multifunctional use of green spaces, such as increased use, enhancement of quality and richness of experience.

Park managers may work directly with the local community. This may have positive benefits in the process of management and developing parks and urban green spaces (ODPM, 2002). A shared sense of managed space in the development process could help to bring people of different backgrounds into greater community cohesion.

The main advantage of a high degree of community involvement also has potential for the creation of broad partnerships for urban green space, especially at the larger scale. It is not just to increase use and activities in a single site, but also to raise the overall level and quality of urban green

spaces through communities and partnerships. Furthermore, a lack of community engagement in urban green space management might result in low demand and aspirations for urban green space quality from local people, local groups, communities and businesses (CABE 2004). Barber (2004) points out that community development deserves to be distinct from 'recreation', reaching into the heart of a local authority's purpose, because communities are diverse groups with ethnic, social and cultural differences.

In summary, for management of urban green space to succeed, the community needs to be closely involved. Hence, managers should aim to work with communities and partnerships. Partnership and communities therefore could strengthen and support management groups to achieve their aims. They could also link together and learn from each other and have a stronger relationship (Barber 2004). Therefore, a management plan should recognise and try to draw together the diversity and range of community needs (CABE 2005b).

3. CASE STUDY: EXPERIENCE FROM SHEFFIELD

The city of Sheffield is one of greenest city in England, and has over 170 woodlands, 78 public parks and 10 public gardens (as figure 1 shows). Moreover, it is the only city in England to include part of a national park and almost 11 km² of water, resulting in 61 percent of the comprising green space. The Peak District National Park, the first national park in England is located on the Southwest of Sheffield. As a selected case study, the city of Sheffield has rich experiences of green space management and enjoyed a range of trusts and friends in urban green space management. This study investigated the management planning for sustainable development. It is benefit to learn experience of management planning from Sheffield which has rich management practices of green and open spaces.



Figure 1. Location Map of Sheffield (Map from: http://upload.wikimedia.org/wikipedia/commons/e/e2/Sheffield_outline_map_with_UK.svg)

3.1 Overview of urban green space policy in Sheffield

A green space strategy is used to set out an authority's vision for developing its green spaces. It promotes the resources, methods and time to meet the goals and vision. *"It is a comprehensive, council-wide document, which should directly contribute to delivering the council's corporate aims and objectives set out in the community strategy"* (CABE 2005a).

Sheffield has a long experience of developing a green space strategy. In 1993, Sheffield City Council published a long-term Parks Regeneration Strategy. The strategy proposed major changes in the way parks and green spaces were managed (CABE 2005a). This strategy policy promoted various spheres such as improving management for people, wildlife and heritage, working with partnerships and communities to review and determine service standards, developing the range services to support activities and making the best use of existing green spaces and bringing more resources in the services.

Through this strategy, Sheffield City Council achieved various developments in managing parks and green spaces. After its expiry, the Sheffield Parks Regeneration Strategy has been replaced by Sheffield's Green and Open Spaces Strategy.

3.2 Promoting community involvement in management policy

Sheffield City Council approved Sheffield's Green and Open Space Strategy (GOSS) in 2010. The strategy developed a vision: "to ensure that every area of the city has green and open spaces of exceptional quality for all current and future generations to use and enjoy"(Sheffield City Council 2010).

This strategy provides a framework for planning, management and improvement of all types of urban green spaces in Sheffield, including both urban and rural areas. It included wider outcomes and management approaches such as setting up management foundations which contents leadership for strategic and collaborative management, long term planning and budgeting and developing management plans for each type of site. Also, the strategy promotes working together with wider partnerships and communities, bringing more opportunities and adopting a stronger pursuit of a range of benefits.

The GOSS contains four themes to improve urban green spaces in Sheffield, namely, People, Places, Environment and Sustainability and Quality Management (figure 2). Through these four themes, the Council pursues development of urban green spaces in a multifunctional sense (Sheffield City Council 2010).

The theme of People in this strategy aims to bring residents and their communities closer together with popular and well-used spaces. As the CLERE model (Barber 2005) argued, green spaces help to strength on the spirit of community amongst resident populations with shared interests. Activities and social impacts are helpful to improve quality of green spaces. People's understanding therefore, encourages local authorities and managers to seek more opportunities. Also, this theme aims to encourage people to adapt healthy lifestyle and get more benefits from urban green spaces.

Further, the strategy also supported education and learning with more natural experiences contain different context from classroom. According to this theme, urban green spaces are recognized as a green network to encourage diversity and inclusion. Therefore, providing for local needs, events and cultural projects are strongly promoted by this strategy.

The theme of People also reflected an understanding of multifunctional green spaces in the community. As Barber (2005) mentioned, urban green spaces also enable a wide range of recreational activity for residents and are largely free to users. The Sheffield Green and Open Space Strategy therefore, includes clear policies to encourage and promote development of community involvement and social benefits from these spaces.

In order to improve all urban green spaces that they were successful and well used, this strategy developed the Places theme. It planned four

priorities for actions, namely making sites accessible and safe, achieving quality by design, valuing local character and heritage, realizing economic value (Sheffield City Council 2010).

Through with these priorities, the Council wishes to provide safe and welcoming spaces for people and easy access to these spaces. Therefore, the Strategy aimed to achieve quality design for different types of green spaces which appropriate to the local and wider area.

Sheffield City Council also recognized the value of local character and heritage in its spaces. As the CLERE model stated “landscape can help to define a sense of place, local character and identity” (Barber 2005, P.21). Sheffield City Council points out that its urban green spaces form an important part of the character of the city’s localities. “They have been shaped by the economy and politics of their day - from the modern regeneration of civic spaces; to the designed formality of Victorian parks; or the wild landscapes of the Peak District National Park” (Sheffield City Council 2010, P. 38). Thus, this theme delivers a series of policies to protect and enhance key features and spaces to conserve local landscapes.

As the CLERE model promoted, Sheffield City Council realized that urban green spaces could bring multiple economic values. According to the text of the Strategy, green spaces have the potential for productive land use and income generation. A high quality environment creates opportunities to attract investment and employee to live and work in the city. Hence, the SGOSS has policies to encourage increasing business opportunities for tourism and outdoor recreation within Sheffield’s urban green spaces. Moreover, it also encourages business and partnership opportunities to engage in sustainable and productive development such as agriculture, waterways and renewable energy.

Third, environment and sustainability has been recognized important to developing in Sheffield as the greenest city in Britain. CLERE model (Barber 2005) has stated that green spaces as an ecosystem provides services to the urban environment. This Strategy points out that green spaces support important plants, animals and habitats. Moreover, as ecosystems provide services, the Strategy recognized that urban green spaces have abilities for absorbing and storing water and carbon dioxide, filtering pollution and providing shade and cooling.

Sheffield City Council has realized that urban green space forms a core part of Sheffield’s infrastructure. In order to support the green network policies of the Core Strategy, this strategy encourages to establish green connections for people and wildlife. It wants people to use and visit local urban green spaces. These links and urban green spaces are thought of as a green connective network which extends out beyond the city boundary and ultimately connects with more areas. Hence, this network, as part of a regional network of green infrastructure, is promoted in the Sheffield Green and Open Strategy to deal with sustainability and multiple services.

Thus, this strategy recommended a series of policies to adapt to climate change, sustaining quality of environment, improved nature and biodiversity, and connections for people and wildlife (Sheffield City Council 2010).

In order to secure the full potential for people, place and the environment in Sheffield, the Council appreciates the importance of quality management. Hence, the SGOSS supports a strategic quality context for the planning of the city's urban green space assets. Here, the management theme has to deal to coordinate the work of a wide range of partners, managers and owners. Furthermore, it also concerned challenge to ensure secure resources for long term management and maintenance. Thus, this strategy proposed that "owners, managers and providers are seen to be working in a coordinated way around a common Sheffield Quality Standard and with a stake in achieving the long term strategic outcomes" (Sheffield City Council 2010, P. 48).

In this instance, the Quality Management theme delivered five priorities for action: providing leadership, achieving more with partners, developing quality standards, improving skills and competencies, securing funding and investment. For example, as one interviewee emphasised, it is impossible to own and manage all the urban green spaces in Sheffield by a single local authority. Therefore, the management of urban green spaces is coordinated with owners and managers. In order to achieve effectiveness and efficiency of quality management, one central organization should assume responsibility and leadership for management and be able to take an overview and consistency in both standards and management planning. Moreover, the strategy also affirmed the Sheffield Standard as a baseline for work to and to assure and receive consistent levels of provision.

Following these policies and proposals, the Strategy has a strategic plan with a twenty year time horizon. The local council realized that delivering the vision is a long term process which requires sub-outcomes to be achieved through short time-scale, and step by step. Therefore, the long term strategic plan is required and is used to maintain resources and provide direction for managers and partners throughout these incremental improvements.

In summary, the Sheffield's Green and Open Spaces delivered a series of theme to improve quality of urban green spaces with a wider range of benefits. These spheres that GOSS considers range from ecosystem services, social impacts, and community involvement to quality management and securing budget resources. The Sheffield's Green and Open Space Strategy provides a direction to local authorities, managers and partners for the future of quality of urban green spaces.



Figure 2: Open and green space strategy programme in Sheffield (From: Sheffield City Council Parks and Countryside 2010)

3.3 Ways of working with communities and NGOs

As discussed above, community groups have become involved in managing urban green spaces. Sheffield has joined with a range of communities, partners and trusts in the management of urban green spaces, such as the Sheffield Wildlife Trust. Moreover, most of the parks and gardens in Sheffield have their own friends groups to support development of individual parks, for example, Friends of Firth Park, Friends of Crookesmoor Park and Friends of the Botanical Gardens. The landscape department works with these friends' groups and supports and advises them in managing local sites, though the department retains a legal responsibility to make the site safe and thereby maintain an influence in design and delivery.

Furthermore, importantly, local authorities understood that community involvement is a bottom-up, voluntary, organic approach. The department suggested that community involvement was generally a case of communities taking the initiative in approaching the department by themselves rather than by being led. The Head of Policy and Projects Section pointed out that *“we don’t go and invent the community groups, but often groups come together because they’re dissatisfied with existing conditions/facilities”*. In this situation, communities and interested groups may have their own preferences to support the relevant management issues. For example, they may want to raise funds or put pressure on the government to seek solutions through community involvement.

Some of these communities have their own agendas for improving relevant sites, but these have to be compatible with the department. The landscape department in Sheffield has a team to work with groups to help them find funds, skills and property. Sometimes, community groups can access sources of funding that the landscape department cannot achieve. Besides, in Sheffield, this is an important role for organisations, third sector work for profit such as Sheffield Wildlife Trust and Green Estate, who manage via long-lease agreements, and can also attract additional income (Head of Policy and Projects Section, personal communication). The landscape department in Sheffield may sometimes work with groups for maintenance and management with division of labour, in loose partnership, for example, the department might cut the grass whilst the partners would do all the other work such as litter picking and managing hedges.

Further, the City Council has promoted Community Assemblies as non-government groups in seven wards to help decide how the Council could better deliver services. The landscape department feeds its priorities through the Community Assembly Plans, and these will feed in additional, local priorities. Sometime, politicians are very interested in seeing improvements in their wards and will put pressure on the Council to commit funds

The Sheffield’s Parks and Countryside Service has a vision to get as much community ownership and involvement as possible. The department considers that people could cherish the space and look after it, and site abuse would be reduced if people were involved in the management process. Of course, local authorities also realised the level of commitment is variable. For example, there may be a lot of anti-social behaviour in some areas, especially in poorer areas where there are more pressing priorities. In order to relieve this condition, the landscape department works with schools and children to build appreciation of landscape values and benefits from an early age.

As discussed above, local authorities and managers are encouraging more communities and partners into the management process in Sheffield. Importantly, cooperation with communities and relevant groups could bring additional benefits. The interests and responsibilities of community and

relevant groups could bring many benefits to developing urban green spaces. As Table 2 sets out, support from politicians to non-government organisations essentially provides extra resources to improve their spaces such as funds and policy priority.

During the management process, local authorities and managers directly manage their urban green spaces, and provide services for achieving management goals. In the management process, the department usually works together with other departments under the local government to achieve management. Relevant groups, friends and communities, as non-government organisations are particularly considered to work together with the local government. In Sheffield, the department has worked with a range of groups and Friends in the landscape management process. In this process, the Parks and Countryside Services, retains a legal responsibility to manage sites and relevant groups offer support and advice to the department in managing local sites. Further, the department also realised that community involvement was generally a case of communities talking the initiative in approaching the department rather by themselves than being led.

Table 2: Cooperation with communities and NGOs

	The Sheffield's Parks and Countryside Service
Relationship between department and communities	<ul style="list-style-type: none"> ● A bottom-up, voluntary, organic approach ● Tend to wait for communities to come to Council rather than leading ● Don't go and invent the community groups, but often groups come together because they're dissatisfied with existing conditions/ facilities
Properties and Function	<ul style="list-style-type: none"> ● Work with third party not-for-profit organisations such as Sheffield Wildlife Trust and Green Estate, who manage via long-lease agreements, and can also attract additional income ● Politicians very interested in improvements, and the Council can sometimes put pressure on politicians to commit funds, essentially, end up with a community plan based on local priorities
Relationship of cooperation ways	<ul style="list-style-type: none"> ● Some groups will have their own agendas (e.g. managing for biodiversity) but these are compatible with the Council's ● Work with small groups of people, for example: may cut the grass and they do all the other work such as picking up litter and managing hedges, like a partnership but simpler ● Feed our priorities through the Community Assembly Plans which will be delivered through the Community Assembly and with local people, and these will include additional, local priorities ● Support and advise local groups, 'friends of' groups, residents' associations in managing local sites, though the department retains a legal responsibility to make the site

	<p>safe and so maintain its influence in design and delivery</p> <ul style="list-style-type: none"> ● Get as much community ownership and involvement as possible, “because they’ll cherish the space and look after it and stop it being abused, if people are involved” ● Works with schools and children to build appreciation of landscape values and benefits from an early age to relieve and resolve anti-social behaviour in some areas
Role of communities and NGOS	<ul style="list-style-type: none"> ● Urban and city spaces are very valued and cherished by people in Sheffield which also helps the council to prioritise and protect, because if there was a proposal to build on green space, there would be a lot of opposition

4. CONCLUSION

In this paper, the purpose is trying to explore way of community involvement in landscape management for enhancing multifunctional urban green spaces. It also purposed to learn experiences of community involvement in process of landscape management which could promoted in a range of management practices in China. This paper has considered that multifunctionality as an important core in green infrastructure enhanced by community activities. The landscape multifunctionality, as ecological, economic, socio-cultural, historical and aesthetic functions are widely promoted, but their attainment and integration are limited by the constraints of a politicized environment, a lack of knowledge, and a great deal of complexity.

The Sheffield study presents an example which is importantly understood by local authorities and promoted in policy context. The importance of community involvement in landscape management is generally considered as a policy support setting out responsibility and priority of management for developing urban green spaces in Sheffield. As discussed in this paper, landscape management is essentially undertaken by the landscape department and cooperated with relevant departments and communities to achieve policy support, resources and knowledge provision.

REFERENCES

- Author, I.M. and Otherauthor, A.N. (2000). Title of a book in italics, Publisher, City.
- Westman, A.B., Eastman, C.M., et al. (1999a). “Title of an article in quotes”, Journal name in italics, 23(4), 2-42.
- Westman, A.B., Eastman, C.M., et al. (1999b). “Title of a chapter or paper in a book also in quotes”, in: Augenbroe and Eastman (eds.), Computers in Building: Proceedings of CAAD Futures ’99, Atlanta, USA, Kluwer Academic Publishers, Boston, 399-423.
- Barber, A. (2004). "The future's bright, the future's green" Spaces & Places. City: Spaces & Places.

Environmental Planning & Green Building

- Barber, A. (2005). *Green Future: A Study of the Management of Multifunctional Urban Green Spaces in England*. GreenSpace Forum Ltd, Reading.
- Barber, A. (2007). "The Future is 'CLERE'." *GREEN PLACES*, February 08, 34-36.
- Brandt, J., Tress, B., and Tress, G. (2000). "Multifunctional Landscapes: Interdisciplinary Approaches to Landscape Research and Management." City: the Centre for Landscape Research: Roskilde.
- CABE. (2004). "Is the grass greener...? Learning from international innovations in urban green space management" CABE Publication. City: Commission for Architecture and the Built Environment: London.
- CABE. (2005a). "Green space strategies: a good practice guide" CABE Publication. City: Commission for Architecture and the Built Environment: London.
- CABE. (2005b). "A guide to producing park and green space management plans" CABE Publication. City: Commission for Architecture and the Built Environment: London.
- CABE. (2006). "Urban Parks: getting for your money" CABE Publication. City: Commission for Architecture and the Built Environment: London.
- CIWEM. (2010). *Multi-Functional Urban Green Infrastructure A CIWEM Briefing Report* The Chartered Institution of Water and Environmental Management, London.
- Department for Communities and Local Government (DCLG). (2012). "National Planning Policy Framework". City: Department for Communities and Local Government: London.
- Ferrari, S., and Rambonilaza, M. (2008). "Agricultural multifunctionality promoting policies and the safeguarding of rural landscapes: How to evaluate the link?" *Landscape Research*, 33(3), 297-309.
- Fry, G. L. A. (2001). "Multifunctional landscapes - towards transdisciplinary research." *Landscape and Urban Planning*, 57(3-4), 159-168.
- Groenfeldt, D. (2006). "How the Multifunctionality concept can restore meaning to agriculture," B. Haverkort and C. Reijntjes, (eds.), *Moving Worldviews, Indigenous Water Initiative*. City: New Mexico, USA.
- Levent, T. b., and Nijkamp, P. (2004). "Urban Green Space Policies: performance and Success Conditions in European Cities" Preliminary Vision: 44th European Congress of the European Regional Science Association, Regions and Fiscal Federalism. City: Portugal
- Li, B. (2009). "Green Infrastructure and limiting urban sprawl 绿色基础设施与城市蔓延控制" *Urban Problems (China)*, 162(01).
- Ling, C., Handley, J., and Rodwell, J. (2007). "Restructuring the post-industrial landscape: A multifunctional approach." *Landscape Research*, 32(3), 285-309.
- Naveh, Z. (2001). "Ten major premises for a holistic conception of multifunctional landscapes." *Landscape and Urban Planning*, 57(3-4), 269-284.
- Office of the Deputy Prime Minister. (2002). *LIVING PLACES Cleaner, Safer, Greener*. Office of the Deputy Prime Minister., London.
- Office of the Deputy Prime Minister (ODPM), and National Audit Office. (2006). "Enhancing Urban Green Space", Office of the deputy prime minister. (ed.). City: The Stationery Office London.
- Sandström, G. U. (2009). "Urban Green Spaces for Human Well-being," *IAIA09 Conference Proceedings*, 29th Annual Conference of the International Association for Impact Assessment. City: Accra International Conference Center, Accra, Ghana.
- Selman, P., and Knight, M. (2006). *Refining Multifunctionality - Final Report to the Countryside Agency*. Department of Landscape, University of Sheffield, Sheffield.
- Sheffield City Council. (2010). "Sheffield's Green and Open Space Strategy 2010 - 2030 ". City: Sheffield City Council: Sheffield.
- Welch, D. (1991). *Management of urban parks*, Essex: Longman Group UK Limited.
- Wu, W., and Fu, X. e. (2009). "The concept of green infrastructure and review of its research development " *Urban Planning International (China)*, 24(5), 67-1.



NO.116

Addressing Heat Island Issue in a Desert City *Striving Towards Sustainability*

Abdulelah Almayouf^{1*}

1 King Saud University

** Corresponding Author, Email: hhmayouf@ksu.edu.sa*

Key words: Heat , sustainability , planning

Abstract: The heat island issue refers to the rise of urban air and surface temperatures which becomes a key task for cities managers around the world. Usually cities have air temperatures that are 1 to 3°C warmer than the surrounding natural areas according to the US environmental protection agency. This temperature discrepancy has impacts, and most of which are negative including; increased energy consumption, aggravated air pollution, and water quality problems. Mitigation the problem should be the objective to make livable and more sustainable cities, especially for cities located in hot and dry regions like Riyadh the Saudi capital. Urban planning can play a key role to reduce the effects of heat islands through a number of changes in the city landscape; buildings roofs using construction codes; roads pavement; and vegetation of open spaces. Such efforts will introduce wide range of benefits including, cleaner air, enhanced public health, reduced energy costs, and lower greenhouse gas emissions. The paper will start by examining the existing conditions of Riyadh city concerning heat island issue. Also, it will highlight the efforts taken by the city's development agencies towards that. Potential amendments to the planning practice in this regard will be presented as well as some concluding remarks at the end of the paper.



NO.118

Urban Regeneration in Smart City *Case Study of TaipeiTech University Town*

Sheng-Ming Ryan Wang¹, Chieh-Ju Huang^{2*} and Kuang-Hui Peng²

1 Department of Interaction Design, National Taipei University of Technology

2 College of Design, National Taipei University of Technology

** Corresponding Author, Email: samenh@gmail.com*

Key words: Creative city, smart city, creative patterns, service design, urban regeneration.

Abstract: This study tries to find the ways to regenerate an urban area in a smart city by using the concept of creative city for improving the image and user experiences of the city. The Taipei Tech University Town (TTUT), which is located in the central area of Taipei city, as a case study area in this research. Nowadays, in addition to the continuing construction and application of information and communication technology (ICT), new and interdisciplinary concepts and methods should be integrated for further development of a smart city. Thus, this study applies both the creative city concepts and service design method to the case study area and to provide solutions for a more flexibility and user-oriented solution for urban regeneration. The common creative language and pattern are then concluded by the integrative analysis of creative city concepts and service design method for urban regeneration.

1. INTRODUCTION

The concept of smart city has been develop in the last years as a response to the development of new technologies and the influence they have on now days society; There is still discussion about the true meaning of the concept and how it can a city can be truly “smart” since the implementation of this concept is not only about the use of technology on the city, but rather a synergy between technology, government and citizens (Hollands, 2008).

The problem with implementing a new urban concept such as “smart city” or “creative city” on an urban regeneration design is the method of obtaining valuable information about the user and how the proposed strategies would fulfil the necessities of the majority of the users(Lee &

Chan, 2008); on response of this issue Service design is proposed as a design method since its approach focus on the user, its need and its interaction with its environment, the smart city.

Based on the concepts mentioned above, this research attempts to explore the further implementation of the smart city concept on the urban regeneration of an existing area of a smart city Taipei City that had been awarded the intelligent communities of the world by the Intelligent Community Forum (ICF) in the year of 2006. The TaipeiTech University Town (TTUT) located in Taipei city; which is an area with cultural history, mixed land usage, abundant urban components and thriving functions that need to be redefined and regenerated. Implementing the tools providing by the Service Design method, the authors propose a series of observations in order to propose ideas of the urban regeneration of TTUT.

2. LITERATURE REVIEW

The definition of a smart city is very complex since it takes into consideration several aspects of the city and its development , however as Caragliu, Del Bo, & Nijkamp, 2009 summarizes , a city is smart when “investments in human and social capital and traditional (transport) and modern (ICT) communication infrastructure fuel sustainable economic growth and a high quality of life, with a wise management of natural resources, through participatory governance.” In a smart city the communication with the community trough high technology is an important factor: it should collect information and share it in order to improve the overall community. The government of a smart city is also interested in support the innovation, small business and new ways of communication and infrastructure.

Under the smart city concept the cultural factor takes an important role inside the life of the city in the form of innovation and creative industries. Landry, one of the first authors who used the term of “creative city”, define it as: “The creative city idea advocates the need for a culture of creativity to be embedded within how the urban stakeholders operates. It implies reassessing the regulations and incentives regime and moving towards a more ‘Creative bureaucracy’” (Landry, 2008). Landy emphasizes the importance of creativity to find potential solutions to urban problems, giving the city “this, the notion argues, will provide cities with the flexibility to respond to changing circumstances and thereby create the necessary resilience to possible shocks to the system”(Landry, 2008).

Winters, 2011 highlights the relationship between education and smart cities; on this research the author investigate the growth on smart cities that are also university towns , stablishing a relationship between education and economic growth, therefore a smart city can benefit from the education of

the student population that seeks better opportunities for their future through innovation.

Gumprecht (2003) defines the University town as “any city where a college or university and the cultures it creates exert a dominant influence over the character of the community”. Gumprecht also remarks that on the university town, university activities influence the life of the city: the student community constantly interacts with the life of the city in several ways such as commercial activities and cultural exchanges between citizens and students.

The relationship between Taipei tech and the TTUT gives an example of the interaction between the university town and the smart city, where the University can affect the life of the city by interacting and communicating with it, Martin, Smith, & Phillips, 2005 defines the areas of interaction between the community and University as: partnership as service learning, Service provision, Faculty involvement, Student Voluntarism and Research in order to create a better understanding among the university and the local community, which creates the necessity of regenerate the current urban spaces.

Urban regeneration is “comprehensive and integrated vision and action which leads to the resolution of urban problems and which seeks to bring about a lasting improvement in the economic, physical, social and environmental condition of an area that has been subject to change” (Roberts, 2000). Roberts remarks the need of an integrated process in order to archive an integrated service of growth on the aspects mentioned above by taking into consideration sustainability, built environment, stakeholders and the user of the space.

The university town is often a smart city; therefore the academic population is a key factor on the life of the city where the students use innovation skills to improve their economic situation. This circumstances creates the necessity of new spaces to fulfil the new creative labour force, the creative city, therefore the urban regeneration of existing spaces should be a response to the changes of the society the space is.

In order to apply the previous concept on a real case study area, this research focus on further improve the existing renovation strategy for the TTUT, a concept already develop by the research team of TaipeiTech (Tsai & Tang, 2012). With the purpose of analyse the TTUT and its image the concepts of node, path and landmark proposed by Lynch, 1960 would be taken into consideration to select the areas where the urban generation should take place and the best strategy to satisfy the needs of the users of the selected areas.

3. METHODOLOGY

On a case study bases, this research would use participant observation to document the city nodes, and landmarks on the study area. The observation would make emphasize the user’s experience each identify node of the study area using the basic concepts of Service Design to analyse the proposals. In order to evaluate the proposals for the urban regeneration of the area The Analytic Hierarchy Process (AHP) would be implemented to analyse the most suitable option for the areas of intervention, given values based on the observation made on the site by the author. All the recorded information was taken in the form of photographs, sketches, videos and diagrams to record the user experience and correctly identify the nodes of the study area.

3.1 Defining the Study Area

Based on previous knowledge of the area, the city nodes and landmarks were identify and later confirmed by participant observation, as shown on figure 1.

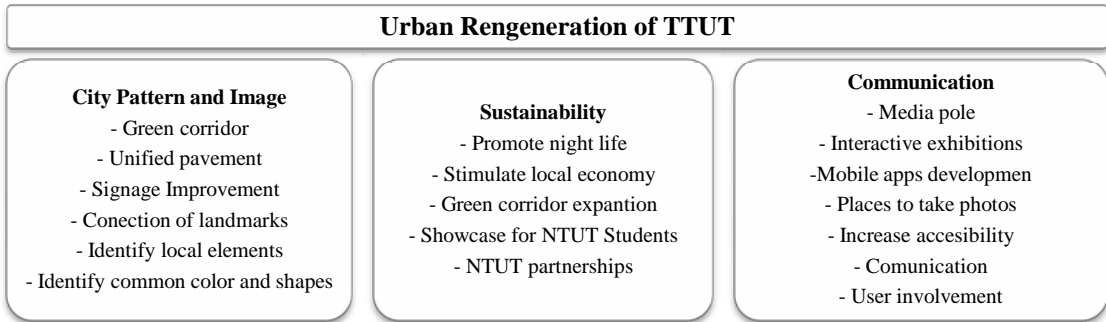

Figure 2. City Nodes: 1. Huashang Cultural Park’s Square 2. Square of Hope 3. MRT Zhongxiao Xinsheng Exit 4.

3.2 The Analytical Hierarchy Process

Based on the proposed ideas for the urban generation of TTUT area was created. This model will be re-arranged by order of importance after the evaluation process (Figure 2).

Figure 2. AHP Structure



3.3 The Analytical Hierarchy Process

3.3.1 Context and Its Development

The Taipei Tech University Town (TTUT), which is located in the central area of Taipei city, is used as a case study area in this study. The TTUT is composed with NTUT, Huasan 1914 Creativity Park, Guan-Hua 3C Mall, CheinGou Beer Factory, and newly built Taipei Akihabara. The area has been developed since the early 1900 providing education, industry, entertainment and culture (Figure 3).



Figure 3. The area between NTUT and HuaShan Cultural Park

3.3.2 National Taipei University of Technology (NTUT)

Open in 1912 and served as a vocational school until 1990 when it upgrade its university status. Currently is well known for its eco-friendly campus that includes a green gate and green roof area for passing birds, a place that has become an attraction for the pedestrian. It is located next to MRT Exit 4 and connected by a public square (Figure 4).



Figure 3. The area between CheinGou Beer Factory and GuangHua 3C mall

4. EVALUATION

By implementing participant observation the authors' goal was to gain information about the needs of the user and evaluate if the proposed strategies should be further explore in future works. The observation was held on weekdays and weekends to have a better understanding of the user's behaviour under different circumstances. Service design tools were used to map the user's experience ("Service Design Tools | Communication methods supporting design processes," n.d.) .

4.1 Observation Results

4.1.1 The User Experience of the Space

After the participant observation and the persona experiment held on Huashan creative plaza (Figure 6A) and the area of NTUT, there were some common aspects discovered on the site:

The user enjoys walking around the area, in NTUT the green gate connected to the square outside MRT exit 4.

Inside the Huashan creative plaza like to walk around and look at the multiple shop and food stands before going to their final destination, either the movie theatre, one of the exhibit or the café and restaurant inside the park.

Most users, specially the younger user, like to take photos on all the nodes or check themselves in using their cell phones.

Most users like to look around different shops, they go from one shop to another to look products and eventually buy something.



Figure 5. The area between CheinGou Beer Factory and GuangHua 3C mall

4.2 National Taipei University of Technology (NTUT) and Square in Front of MRT Exit 4

The Zhongxiao East Rd. and Xinsheng south Rd. axis is one the most congested areas of the city for both pedestrians and vehicles; the sidewalk of the intersection goes along the NTUT green corridor and the main activities there are passing through and wait for the bus. The presence of a dense vegetation and large number of trees contribute to provide shade during most hours of the day and hence a very significant temperature reduction, especially during the hot days (Figure 5).

Regarding the corner square outside of the MRT Exit 4, the main activities observed were waiting for people to meet, observe the pond, reading and chatting, take and drop off taxi, and access to University, watching information displayed in the big LCD screen and the media pole, that displays images of nature

4.3 AHP Weight

After the participant observation, the aspects discuss on the methodology section, the objectives of the AHP are re-ordered based on its important according to the observation made of the site by the author. The Most important aspects of the urban regeneration have been order according to the categories established on the early stages of the research. The main

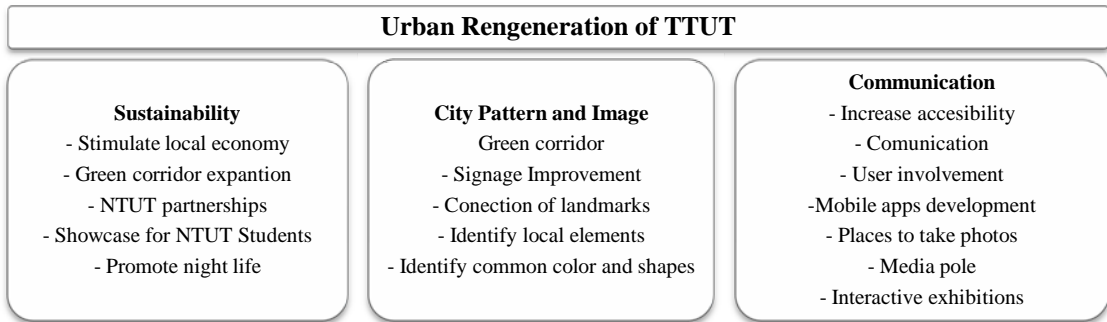

areas where the future development of the area should focus according to the author are shown on Figure 6.

Figure 6. AHP Process weighting

Based on the AHP process (Figure 6), the need of a clear language between the mentioned zones becomes clear: the need of a new urban pattern that unifies the four city nodes would help to connect them and to improve the already form bound between them. The proposed strategy for the urban regeneration of the area consists on a two parts plan:

1. Create a common language that connects the four areas in the form of a special pavement that helps to reference the user, using a similar concept like in “Olivera street” in Sao Pablo and the expansion of NTUT green corridor :
 - The strategy would support the idea of a walk able neighbourhood
 - The use of green architecture elements such as green walls , roofs and garden can be a showcase on how to be sustainable on a big city and help to improve the city image, following the concept introduce by NTUT on its green corridor development
 - The nature spots and landmarks are a good place for taking photos and promote group interaction, as mentioned on the observation on the landmarks.
2. In order to be successful in improving the area with the creative city concepts the citizens should be informed of the concepts of smart and creative city and how they can get involve with it. The author proposes the uses of a special app for the cell phone that would

allow the user to play with the area and discovered new places. This idea would have several benefits:

- Would create a data base that would register the user experience of the urban area and could help to future develop the area on the spots that the user enjoys the most.
- It is an intuitive and easy to use way of getting to know a place that can be used by local and no local users if the app is available on multiple languages and well designed.
- Is a low cost implementation plan that can lead to better design of other ideas.

5. EVALUATION

The creative city context is a good approach to improve not only the image of the city, but also to support the smart city concept since both concepts can interact and integrate one to another. The creation of a new city pattern using these concepts as a base can help to achieve more flexible and user orientated solutions that have more chance to be embrace by them (Figure 7).



Figure 7. Proposed Strategy

The new Creative pattern for the city would be the integration between real life and ICT, Real time installation (pavements and green corridors) that promote ecological awareness and interaction online by apps and interactive LED installations that would serve as landmarks for the area, helping to improve the mobility and communication between the user and the urban space, as shown on the project “U-Street” in Seoul, where media poles have been installed to show art , commercial advertise and are also free Wi-Fi spots . Following this example the media pole outside the MRT

Exit 4 can display a more diverse content and make emphasis on creating content and services that are not already covered by the cell phone.

Following examples like the “Seonyudo Island and the Hangang River Renaissance” on Seoul as part of the World Design City initiative, the use of natural elements can attract people to places before forgotten and promote local business by the proper use of creativity on the design of public spaces: the design attracts new visitors that have new needs that need to be fulfilled; with the cooperation of the multiple stakeholders of the TTUT area the economic growth through a creative industry is highly possible.

6. CONCLUSION

The urban regeneration of a city should be user centred and seek for integration and innovation, therefore it is important to find new ways to register and interpret the user experience to create spaces that can be functional not only for the present user, but also for future use of the space.

The creation of new patterns in the city as part of an urban regeneration plan has to be developed based on the user of the space and its behaviour, but this is not enough, the researcher must also forecast the needs of the future user based on the current user in order to warrant the successes of the space for future generations

This generation characteristic is its connection with technology, therefore an urban space cannot only focus on the physical aspects of it, should also approach the technology aspects of the user through ICT technology. The new urban space should approach the user in every sense, not only physically but also should approach them on a technological way, the current ICT technology can improve a space if it uses on the right way.

REFERENCES

- Alexander, C. (1974). A city is not a tree. utg. Retrieved from <http://courses.arch.ntua.gr/fsr/142492/Alexander,%20A%20City%20is%20Not%20a%20Tree-2.pdf>
- Caragliu, A., Del Bo, C., & Nijkamp, P. (2009). Smart cities in Europe. Vrije Universiteit, Faculty of Economics and Business Administration. Retrieved from http://www.cers.tuke.sk/cers2009/PDF/01_03_Nijkamp.pdf
- Gumprecht, B. (2003). THE AMERICAN COLLEGE TOWN*. *Geographical Review*, 93(1), 51–80.
- Hollands, R. G. (2008). Will the real smart city please stand up? Intelligent, progressive or entrepreneurial? *City*, 12(3), 303–320.
- International Council of Societies of Industrial Design. (n.d.). World Design Capital | an initiative of the International Council of Societies of Industrial Design. World Design Capital. Retrieved August 5, 2013, from <http://www.worlddesigncapital.com/>
- Landry, C. (2008). *The Creative City: A Toolkit for Urban Innovators*. Earthscan.

Environmental Planning & Green Building

- Lee, G. K., & Chan, E. H. (2008). The analytic hierarchy process (AHP) approach for assessment of urban renewal proposals. *Social Indicators Research*, 89(1), 155–168.
- LEMOS, A. (n.d.). Medialab-Prado Madrid. Digital Networks and Physical Space.
- Lynch, K. (1960). *The image of the city* (Vol. 1). MIT press. Retrieved from http://books.google.com/books?hl=en&lr=&id=_phRPWsSpAgC&oi=fnd&pg=PA1&dq=kevin+lynch+the+image+of+the+city&ots=jFF32d6Bhg&sig=M1XOBRq8KUgoYYddgJoiMP-KKgY
- Martin, L. L., Smith, H., & Phillips, W. (2005). Bridging “Town & Gown” through innovative university-community partnerships. *The Innovation Journal: The Public Sector Innovation Journal*, 10(2), 1–16.
- Nam, T., & Pardo, T. A. (2011). Conceptualizing smart city with dimensions of technology, people, and institutions. In *Proceedings of the 12th Annual International Digital Government Research Conference: Digital Government Innovation in Challenging Times* (pp. 282–291). Retrieved from <http://dl.acm.org/citation.cfm?id=2037602>
- Roberts, P. (2000). *Urban regeneration: a handbook*. London [u.a.: SAGE.
- Service Design Tools | Communication methods supporting design processes. (n.d.). Retrieved August 30, 2013, from <http://www.servicedesigntools.org/>
- Tsai, J.-H., & Tang, Y.-T. (2012). National Taipei University of Technology Development of Ecological Campus. In *Design for Innovative Value Towards a Sustainable Society* (pp. 1049–1054). Springer. Retrieved from http://link.springer.com/chapter/10.1007/978-94-007-3010-6_222
- Winters, J. V. (2011). WHY ARE SMART CITIES GROWING? WHO MOVES AND WHO STAYS*. *Journal of Regional Science*, 51(2), 253–270.

Infrastructure & Transportation

Planning

NO.5

Methodology for Management of Hydric Resources on Madeira River Basin.

Flavio de São Pedro Filho^{1*}, Janilene Vasconcelos Melo², Creuza Gomes Batista³, Jeoval Batista da Silva⁴, Alex Rotta Romani⁴ and Alexandre Leonardo Simões Piacentini⁴

1 Management of the Federal University of Rondônia

2 Management of the Federal University of Rondônia - UNIR.

3 Federal University of Rondônia – UNIR. CAPES scholarship holder.

4 Management of the Federal University of Rondônia

**Corresponding Author, Email: flavio1954@gmail.com*

Key words: Madeira River Basin. Management. Water Resources. Sustainability

Abstract: Issues relating to the area in the Amazon includes water management in the biggest Hydrographic Basin of the Planet. This work involves a methodology for the management of hydric resources in support of environmental sustainability on the Madeira River Basin; it brings as specific objectives raise the main informational subsidies for sustainability in the scenario study (1), analyze the water resources management instruments such as subsidies proposed methodology (2), and propose procedural innovation based on Theory U (3). The task is based on the Theory U to answer the question: How the methodological procedural innovation would contribute to the management of hydric resources of the Madeira River Basin? To answer this question it was used the Content Analysis Method, of qualitative nature and the usual procedures. As a result, it was found that the lack of control over environmental risks, a task which is responsibility of the Union and the States (1); that the actions of planning in the face of the decision making for sustainable development impacts negatively, exposing the inefficiency of the government in the administration of water (2), and the National Pact for Water Management, also known by the acronym PROGESTÃO can be considered as an innovative methodology. It is concluded that the implementation of innovation in this methodology will result in significant cooperation between the central and state government for the use of water, while protecting aquatic ecosystems. However, water management in the Amazon remains precarious. without basic sanitation, while urban streams are transformed into drains of debris thrown irresponsibly on the Madeira River.

1. INTRODUCTION

Issues relating to the area in the Amazon includes waters management in the biggest Hydrographic Basin on the planet. This work involves a methodology for the management of water resources in support of environmental sustainability on the Madeira River Basin. It is based on sustainability as a new paradigm, since it implies prisms on the relationship between humans and their environment, and the complex transformations of social life, political and economic. Study a methodology on t he management of hydric resources is a priority commitment in the face of the scarcity of drinking water, as it is experienced today throughout the Northeast and Southeast of Brazil.

This task presents a b rief theoretical review, which begins with the Theory U, and then follows with the main concepts of informational subsidies required in this study, being, the environmental risks, the characteristics of the Madeira River Basin, economic base, the challenges for the management of hydric resources in the State of Rondônia, definition of sustainability, definition of the National Pact for Waters Management - PROGESTÃO and definition of innovation.

The overall goal in this research is to study a methodology for the management of hydric resources in support of environmental sustainability on the Madeira River Basin; and also three specific goals, namely, raise the main informational subsidies for sustainability in the scenario study (1), analyzes the instruments of hydric resources management as subsidies to the proposed methodology (2), and proposes methodological procedural innovation based on Theory U. The question to be answered is: How the proposed methodological procedural innovation might contribute to the management of hydric resources of the Madeira River Basin?

2. THEORETICAL REVIEW

Theory U is the approach proposed in this topic of the task. It was considered that the current global scenario requires institutional changes in the face of intense organizational conflicts, local, regional and transnationals. Leaders face difficulties before these crises that reflect the varied social practices. Scharmer (2010) considers that Theory U is a change management technique aimed at leadership as a process of knowledge innovation in society; in context, this Theory allows us to design and conduct collective learning processes, and promote organizational changes required, taking as a tool the concepts outlined in Restructuring, Redesign, Reconsider and Regenerate.

The dynamics of U diagrammed by the Theory as Figure 1 below presents three phases; the first reports an open mind that allows the feel of

the causal relationship; the second refers to open heart that guides the witness of the facts; and, as a third, the will open which leads the process to take place.

Following the study in Scharmer (2010), it is possible to define the U by its practice interconnection targeted for change. The interpretation indicates that the decline on the left of the diagram, the individual travels the path of understanding about their mental models built of its reality. The base of the U according to the author is a space for reflection; there the individual matured knowledge it self and the environment, which allows you to understand the current reality and thus, start a process of innovation embodied in the rise of U, on the right of the same diagram. In this part, all new ideas are put into practice, which is not the end, since the process can restart all stages as a review, if necessary.

According to (Sarkissian (2010)), the core of Theory U is in origin an opening of the heart and mind in order to generate a future of present actions, rather than focusing on patterns of the past. The author registers that the future is built the present. For (Leão (2014)), the Theory U has as purpose to present a concept of social change, transformative nature in aid to the leaders in the face of challenges.

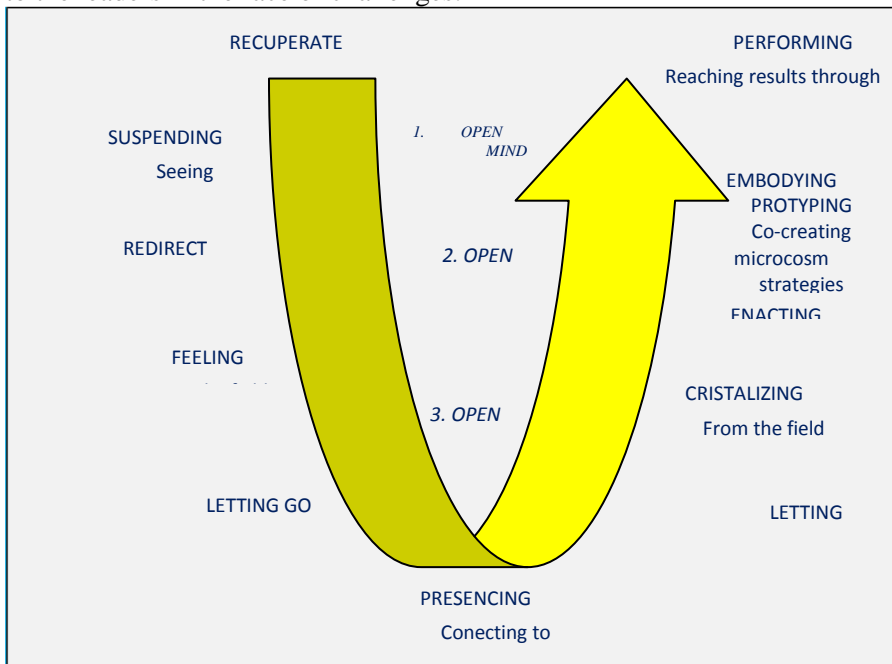

Figure 1: Diagram of Theory U in Schramer
Source: Adapted from Scharmer (2010).

2.1 Concepts on the main informational subsidies required in this study

For the proposed research it was approached some subsidies that would support the information. These would allowed us to analyze the references that relate to the study of the object. When humans cause changes in the natural environment to meet their individual needs or of the society, it results in a predatory action on the environment. In this aspect, arises the necessity of managing the environment. In accordance with (Silva Junior (2010)), the climatic conditions of the Amazon and the process of occupation on the banks of rivers, associated with the uncontrolled growth of the population, have pressed vulnerable ecosystems, such as seasonally flooded areas, which is a vulnerability factor for these populations. The vulnerability can not be analyzed without considering the threat that a community has to be affected or damaged, which can result in environmental and social degradation.

According to the classification of the National Water Agency (ANA), the Madeira River Basin is called Sub-Basin number 15 of the Great Basin of the Amazon River. Surveys done by (Matias (2011)) and data in SEDAM (2014) point out that the Madeira River Basin has an area of 31,400 square kilometers forming the third largest of the seven predominant watersheds in the State of Rondônia, as seen in Figure 2 below.

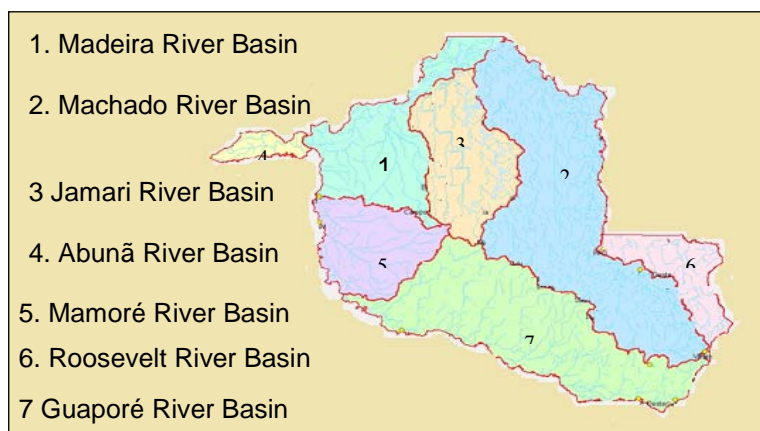

Figure 2: Hydrographic Basin of Rondônia State
Source: Adapted from Sedam (2014).

The Madeira River Basin has different characteristics that require careful studies for the evaluation of an appropriate water management. These features begin to appear by its own name, once it is connected by the many tons of wood carried by the river. This gives an indication of the strength and erosive power of its water flow, the charge potential of sediments that, actually, influence the entire ecosystem. The economy generated in this basin involves activities such as agriculture, mineral

extraction, industrial, trade and services.

Even in the economic context, (Matias (2011)) indicates that the Madeira River has significant hydroelectric potential and has 15 hydrographic accidents along its higher course, the so-called High Madeira. In two of these accidents were built two Hydroelectric Power Plants, the Santo Antonio and the Jirau, as Figures 3 and 4, which interconnect the State of Rondônia to the Brazilian Energy Complex; it composes, this way, the national geostrategic planning. These projects aroused expectations with respect to socioeconomic interventions, financial and environmental of the Region.



Figure 3: Santo Antônio Hydroelectric Power Plant, located on High Madeira River. Source: Internet of public domain.



Figure 4: Jirau Hydroelectric Power Plant on High Madeira
Source: Internet of public domain.

The informational background points out that the interventions of socio-economic nature, financial and environmental of the Region, arising from the installation of these two Hydroelectric Power Plants on the Madeira River Basin has the as features to promote the local economy, generation of new jobs, increasing income, strengthening members of organizations, raising the income of the public sector and the increase in the supply of electricity.

According to (Matias (2011)), the production system of the State of Rondônia is consolidated in the primary, secondary and tertiary sectors. In the first sector are developed branches of Agriculture, Livestock, Extraction Plant, Forest and Mineral. The business braches developed in the secondary sector are: Agribusiness, Wood Processing Industry in logs and furniture, and Building Industry.

In addition, the tertiary sector develops in the fields of wholesale commerce, retail and services with gas stations, hospitals, hotels and restaurants, travel agencies, carriers, professionals, public service, tourism, banking system, school system, radios, newspapers and television. According to (Matias (2011)) this is the sector that most grows and develops in the State due to the urban development.

The economic scenario of the State of Rondônia present itself in great expansion, this allowed the State insertion and expression in national and international market. According to the Secretariat of State for Environmental Development (SEDAM), with the operation of the Waterway of the Madeira River, the state will have a better position to compete with its production in other regions of the country's markets. In addition, the hydroelectric enabled great importance to the industrialization process of the State. However, some hydrographic regions have problems

with the misuse of soils in the watershed areas. Aiming to overcome these challenges the State Government through Decree No. 18.045/13, joined the PROGESTÃO - National Pact for Water Management, which aims to build commitment among federal agencies, aimed at overcoming common challenges and promotion of multiple and sustainable use of water resources.

There are several understandings of the meaning of sustainability, and significant is the official definition of the Organization of the United Nations, coming from the Brundtland Report. In this report, it is considered sustainable development as one that meets the needs of present generations without compromising the ability of future generations to meet their needs and aspirations.

In accordance with (Curi (2011)), it only makes sense to think about Sustainable Development when environmental, social and economic aspects are taken into consideration. In this context, it is understood that Sustainable Development promotes the interaction of these aspects. In order to achieve environmental sustainability there must be balance between the conditions shown in Table 1.

Table 1: Conceptual description of sustainability.

Dimensions of sustainability	Characteristics of the Dimension
1. Environmental	1.1 It covers the relationship between the man and the environment in a sustainable development perspective.
2. Economic	2.1 It involves the use of natural resources in order to obtain wealth.
3. Social	3.1 It covers a set of interactions, requiring cooperation among individuals.
4. Viable	4.1 Parameter in the management of the interaction between ecological and economic dimension.
5. Fair	5.1 Model for interaction between the elements of social and economic nature.
6. Tolerable	6.1 Tolerance Category it is essential for the interaction between the elements of ecological and social nature.
7. Sustainable	7.1 It involves the result of the conscious use of natural resources in order to supply the needy of the present generation without compromising future generations.

Source: Adapted from (Curi (2011)).

Each component of the Table 1, needs to be analyzed as a priority in decision-making, so that actions are based on a strategy to anticipate and

prevent.

Definition of the National Pact for Water Management – PROGESTÃO

It is a commitment to institutional links between the Union and States, recommended by Law 9.433/97, which aims consists in overcoming the national and regional challenges in the management of hydric resources in order to promote multiple and sustainable use of water resources particularly in shared basins (PROGESTÃO (2013)). In addition to the foundations the National Hydric Resources Policy, the PROGESTÃO is guided by the main assumptions described in Table 2.

The States are responsible for deciding the type of management that best meets its future vision, evaluating their reality and their claims. However, once established this typology, he States should adopt commitments and goals and yet stipulate targets that might enable the achievement of success.

Innovation Concepts

There are several concepts for innovation, following the definition shown in Oslo Manual (OECD, 2005), innovation is the implementation of a product (goods or service) new or significantly improved, or a process, or a new marketing method or organizational in business practices, organization of the workplace or external relations. (Bloch (2010)) seeking to adapt the proposal of the Oslo Manual to the public service context, proposes that innovation is seen as the implementation of a significant change in the way the organization operates or in the products it offers. For (Bloch (2010)), although specific elements may be similar to business environments, there are important differences in relation all procedure as a whole in which ideas are created, processed and implemented as innovations.

Table 2: Premises of PROGESTÃO

Premises	Description
1. Strengthening of the State System of Hydric Resources Management	1.1 The intended integration of the National Hydric Resources Management System. In order to ensure that the State structure, tools and resources needed for sustainable development. 2.1 The fulfillment of commitments between the entities, culminating in inquiry over time. For this, it is essential to translate them into goals, defining respective responsible, scope (success conditions) and deadlines.
2. Commitments to goals	
3. Defined control targets by consensus:	3.1 The control targets of shared water resources, unlike the institutional goals will depend on the negotiation and consensus process among federal entities.

Source: Adapted from (PROGESTÃO (2013)).

3. METHODOLOGY APPLIED IN THE PREPARATION OF THIS TASK

In this research will adopted formal and systematic process of the scientific method. To (Creswell (2010)), research projects are the plans and procedures for research covering decisions from broad assumptions to detailed methods of collecting and analyzing data in order to provide answers to the problems that are proposed.

Adopter of the Qualitative Method in this research. Under this approach, it was elected the Content Analysis Method to enable the proposed intervention. Mozzato and Grzbovski (2011) define this method as a set of communication analysis techniques through systematic means and description of the objectives of the messages with the intention of analyzing the content and infer knowledge of the conditions of production and indicators. In regard to the purposes, this research describe as a methodology that contribute to the management of hydric resources to support environmental sustainability on the Madeira River Basin.

Referring to the data collection procedures, (Creswell (2010)) indicates that the idea of qualitative research is the intentional selection of participants or locations, as well as, the selection of documents or graphic materials that will help the researcher to understand the problem and the research question. Following this author, it was considered the Brazilian official document on the theme, which is the National Pact Consolidation Program for Water Management - PROGESTÃO, Volume I and II.

In the presentation of the data source it is worth informing that the content was published on March 2013, the Volume I presents the conceptual aspects and it is composed of 18 pages, in Volume II is presented the program strategy and consists of 16 pages and finally, the Annex IV presents the management variables of Hydric Resources of the Rondônia State.

The Data analysis discussion may have several components, mostly consists of extracting meaning from the text. (Creswell (2010)) argues that it involves preparing the data for analysis, conduct different analyzes, deepen increasingly the understanding, representation of data and to make a broader interpretation of the your meaning.

Data collecting in (Creswell (2010)) suggests a process of constant analysis involving continuous reflection on the open data. This analysis has origin from general questions through which develops the cleavage required information coming from the participants. Therefore were developed four questions in this study that categorize the object of analysis and criticism. 1) PROGESTÃO includes control platform on environmental risks on hydric resources? 2) The PROGESTÃO on the Madeira River Basin allows advancement in public policies for sustainable development? 3) What are the challenges that the state of Rondônia will face to the management of

water resources in the face of PROGESTÃO? 4) Are there links operationalization of PROGESTÃO to sustainability?

Prepared the categories, the results will be presented according to (Creswell (2010)) indicating the rescue quotes and text fragments studied with interpretations made by the researcher.

4. HYDRIC RESOURCES MANAGEMENT ON THE MADEIRA RIVER BASIN: AN OPERATIONAL METHODOLOGY

In this step, it will be presented the results of the proposed study. Which is based on sub-topics that approach the survey of the main informational subsidies for sustainability in the scenario in study, the analysis of the hydric resources management tool, and the analysis of procedural innovative proposal based on the Theory U.

Concerning to the informational subsidies for sustainability were listed its features, as set out in Table 3 below.

Table 3: Characteristics of informational subsidies for sustainability.

Elements	Characterstics
Environmental Risks	1.1 Potential damage on hydric resources by inappropriate waste handling, inappropriate use of fertilizers or pesticides, construction of hydraulic works, sanitary landfills.
Madeira River Basin	2.1 It is the third largest river Hydrographic Basin of Rondônia and has own characteristics that require careful studies for the evaluation of an appropriate hydric management.
Economic Basis	3.1 Production system based on primary, secondary and tertiary sectors.
Challenges for the management of hydric resources of the State of Rondônia	4.1 Power generation with hydroelectric exploitations of the Rivers and the maintenance of hydric bodies.
Sustainable Development	5.1 It is the one that meets the needs of present generations without compromising the ability of future generations to meet their needs and aspirations.

Source: Own authorships.

As a result of these characteristics, the implementation of a new hydric resources management methodology will add to the Madeira River Basin the instruments to combat of eminent rich environmental, the preparation of studies for the evaluation, control and supervision over the use of its resources, and even consistent adhesion practices with the principles of sustainable development.

The hydric resources management tool adopted in this task reports to the National Pact for Water Management (PROGESTÃO). In this sub-topic is the summary of the analyzes obtained in the document base of the National Pact for Water Management, Volume I and II, this allowed to focus on appropriate subsidies to meet the specific objective of this study.

The content of PROGESTÃO states that the control over environmental risks is responsibility of the Federal and the States Governments, which exert regulatory function of the use of water, protection of the environment and combating pollution. This shared management will require a process of negotiation and consensus building among actors.

The PROGESTÃO provides variable minimum conditions set by the National Agency of Waters through Resolution No. 379/13. And the Secretary of State for the Environment is the organism responsible for presenting the State's situation through the goals form filling which were listed in Table 4.

Table 4: Control Variables

Variables	Current Situation of the Rondônia State
Cartographic basis	1.1 there is an area specific own, responsible for the processing of georeferenced data and analysis of the geographical context of hydric resources.
Users Cadaster and Infrastructure	There is user cadaster, but there is no more registration of hydric infrastructure.
Hydrometeorological monitoring	3.1 There rainfall networks and/or fluviometric operated at the state level, without plan for implementation, expansion and modernization.
Water Quality Monitoring	4.1 There is a network of water quality at the state for to evaluate the tendency, at odds with the National Program of Water Quality.
Information System	5.1 There are organized information on hydric resources, with access to the database for management use.
Research, Development and Innovation	6.1 There are financed actions and/or promoted water management, aimed at scientific research and technological development.

Source: Adapted from PROGESTÃO - SEDAM (2013)

The analysis of the current situation of the Rondônia State concerning to the control variables is worrying, because with the exception of the cadaster of user variables /infrastructure and information system the State has reached the minimum level of requirements set by the National Agency of Waters (ANA), which reflects the urgent need to implement a new methodology to ensure control over environmental risks in the use of hydric resources.

Because it is an institutional articulation of compromise between Union and States that aims at overcoming the national and regional challenges in the management of hydric resources intended to promote sustainable development in the region, PROGESTÃO is presented as a breakthrough of regional public policies, because the idea of formulating a national management system for water resources is not new, around 1934 the Brazilian State assumed the role of promoting economic and social development through hydric resource management which culminated in the preparation of the Water Code.

Since then, it was experienced different water management models, where it was found a long delay with respect to the goal of integration of hydric resources policy with sectorial policies. From this evidence, according to the directives of the Brazilian Environmental Law, it is proposed as a strategy for cooperation between federal entities the formalization of a National Pact for Water Management. Which presents in its content as major objective the sustainable promotion through the management of hydric resources. In Table 5 it is possible to see the current situation of the State of Rondônia presented by SEDAM, regarding to the public actions in the planning framework on hydric resources that enable decision making focusing on the regional development. It is worth emphasizing that the PROGESTÃO states variables of minimum conditions, which are established by ANA.

Table 5: Planning Variables

Variables	Situational Descriptive in the State of Rondônia
Hydric Balance	There is an adequate understanding of the demands and hydric availability under state domain in some areas, through specific studies or hydric resources plans.
Hidrographic Division	There is a hydrographic division recognized, reliable and formally established.
Institucional Planning	3.1 There is a strategic plan approved for the actions of public Administration in the management of hydric resources and further there is the need to create and/or improve the instruments and conditions for their effective implementation.

Variables	Situational Descriptive in the State of Rondônia
State Planning of Hydric Resources	4.1 There is state water plan approved by the State Council, but there is still the need of updates, revisions and/or there are no instruments or conditions for its implementation.
Basin Plans	5.1 There are no basins plans approved by state Committees. 6.1 There are no hydric or hydrogeological bodies framed under the terms of CONAMA No. 357/2005 and 396/2008, or studies or proposals for classification of framing of surface and underground waters of the state domain.
Framing	7.1 There are special studies for some topics of interest of the management in state scope, and these studies are updated and are sufficient to guide management actions on aspects addressed.
Special Studies of Management	8.1 There are systems and/or support models the operational decisions at the state level, but their use is still relatively limited.
Models and Decision Support Systems	

Source: Adapted from PROGESTÃO - SEDAM (2013)

The analysis of the actions of planning front the decision-making for sustainable development cause great negative impact. Because besides the State provides most of the variables only the minimum level of requirements and conditions set by the ANA. Still exposes its total inefficiency in the Basin Plans and planning framework.

In the construction of this study, it was found that some states have great difficulties in consolidating institutional structures appropriate to the management of hydric resources. Before the scenario of the PROGESTÃO seeks to strengthen of the State System of Hydric Resources Management (SEGREHs). Table 6 presents the current situation of the State of Rondônia front of the consolidation of institutional structures appropriate to the management of hydric resources.

Table 6: Institutional Variables

Variable	Current Situation of the Rondônia State
Institutional Organization of Management Model	1.1 There is any Public Administration area that acts in the management of hydric resources, which is reasonably structured, without conflicts with work, management or the user sectors.
Organism(s) Coordinator/Manager	2.1 The Organisms Coordinators and Manager exist and are the same entity, which is fully structured and active.

Variable	Current Situation of the Rondônia State
Processes Management	3.1 The managing organism has managerial and administrative processes and procedures well established for implementation of some of its duties.
Legal Framework	4.1 There is a basic framework and most of the legal provisions is regulated and updated.
State Council of Hydric Resources	5.1 There is a Council established and active in water management and working under appropriate conditions.
Committees of Hydro Basin and Collegiate Organisms	6.1 There are state committees and/or collective organisms of hydric resources in some basins/critical areas.
Water Agencies and Delegated Entities	7.1 There is no support for the operation of collegiate bodies and executive secretaries of River Basin Committees installed.
Social Communication and Dissemination	8.1 There are some actions of social communication and dissemination of information on topics related to the management of hydric resources, but it lacks professional technical basis and/or planning for these claims.
Sectorial training	9.1 There is training program at the state level for topics related to the management of hydric resources, but it is not a properly formalized program, carried out continuous mode and based on the determination of demands studies.
Articulation with sectors Users and transversal	10.1 Is there any articulation of the public power with users and transversal sectors, but restricted to activities carried out under the State Council, committees and collective bodies of hydric resources.

Source: Adapted from PROGESTÃO - SEDAM (2013)

In this scenario, the challenge that the State of Rondônia will have to overcome is the strengthening of institutional structures, considering also that in these variables, the state remains presenting the minimum levels of requirements and conditions set by ANA. Still exposes its total inefficiency as the deployment of Water Agencies and Entities Delegated.

The sustainable aspects are entirely linked to the assumptions of PROGESTÃO, to promote the compatibility of public policies that use hydric resources guided by the sustainability in its various dimensions. Table 7 below shows the current situation of the State of Rondônia in the face of the implementation of sustainable use of hydric resources.

Table 7: Operational Variables

Variables	Current Situation of the State of Rondônia
Grant rights of use	1.1 There is issuance of concession of hydric resources rights for the abstraction of water, as well as for effluent discharge and it was granted more than 15% of the universe of users.
Supervision	2.1 There is supervision of granted users linked to the process of regulation of the use of water, but there is no specific structure for development of inspection activities.
Charge	3.1 There is not any type of collection, or by raw water services or the use of water. And there are no studies or regulation on the issue at the state level.
Financial Sustainability Management System	4.1 The state system of hydric resources has its own sources of revenue, but this collection is less than 20% of the financial resources needed to ensure its financial sustainability.
Hydric infrastructure	5.1 All water infrastructure management is carried out by other areas of public administration and there is no participation or influence of the area of water resources in water management.
Management and Critical Control Events	6.1 There is infrastructure and procedures established for monitoring critical events, as well as planning and execution of actions to control and mitigate the effects of extreme hydrological events, existing although greater need for coordination among the actors and federal integration to implement of these actions.
State Hydric Resources Fund	7.1 There is a State Hydric Resources Fund provided by law, properly regulated, but it is not yet operational.
Inductors Programs	8.1 There is no type of program or inducer project for the management of hydric resources at the state level.

Source: Adapted from PROGESTÃO - SEDAM (2013)

It is observed by analyzing the operating variables developed in the context of Rondônia the need to assume commitment to effective coordination between the management and control processes in order to overcome common challenges and promoting multiple and sustainable use of water resources especially on Madeira River Basin.

4.1 Proposal for procedural innovation based on the Theory U.

The content analyzed in PROGESTÃO regarding procedural guidelines have characteristics identified in the dynamic phase of Theory U. As listed in table 8.

As a result of this intersection, it is possible to see that the PROGESTÃO classifies itself as an innovative methodology for the management of water resources in support of environmental sustainability on the Madeira River Basin and has support in Theory U.

Table 8: Phases Theory U and procedural guidelines PROGESTÃO.

Phase	Theory U	PROGESTÃO
1. Open mind	Ability to suspend evaluations and judgments tied to mental models and a fresh look at the reality. Search the intellectual intelligence.	1.1.1 It presents an analysis of a set of determined variables, which allows verification of the current reality of the hydric resources management front the sustainability.
2. Open heart	2.1.Ability to refocus on the emotional intelligence (see with the heart), viewing this way the whole.	2.2.1 Sets targets associated to the future vision of the challenges to be faced.
3. Open will	3.1.Ability to undress of outdated mental models and connect with the desired future.	3.3.1 It effectives the commitments agreed between the parties pointing to the definition of the objectives to be achieved on investigation over time. Therefore, it is essential to translate them into goals (intermediate and final), defining respective responsible, scope (success conditions) and deadlines.

Source: Adapted from (Scharmer (2010)) and (PROGESTÃO (2013)).

Required innovations with the implementation of this new methodology, which relates to the consolidation of an integrated management of federal entities in the exercise of common competences will be demonstrated in Table 9.

Table 9: Required innovations with the implementation of PROGESTÃO.

Innovation	Detailing
1. Strengthening SEGREHs	1.1. The intended integration of the National Hydric Resources Management System, in order to ensure that the State structure, tools and resources needed for sustainable development.
2. Commitments to goals	2.1. The effectiveness of the commitments agreed between the parties depends, in good measure, to the clear definition of objectives to be achieved and, not least, the possibility of its investigation over time.
3. Goals associated to the future vision (prognosis)	3.1 From the elements of this prognosis that may define the institutional development goals and control aspects of quality and quantity of water.
4. Institutional development from the states' aspirations	4.1. The state enjoys full autonomy to define the institutional structures, which suit its reality, and shall, therefore, define goals of institutional development goals in its scope of action.
5. Defined control targets by consensus	5.1. The Union and the Brazilian states exert function of regulating the use of water in their respective fields and holds common responsibilities for the protection of the environment and combat water pollution. Thus, the qualitative and quantitative control goals of shared water resources, unlike the institutional goals will require a process of negotiation and consensus building among federal entities.

Fonte: Adapted from (PROGESTÃO (2013)).

These innovations resulted in cooperation between Union and State for effective regulation of water use and protection of aquatic ecosystems. For this, it is up to state the definition of the management type that best reflects its vision of the future, observed its reality and its aspirations. However, once defined this typology, commitments should be done and therefore stipulated institutional development goals that would achieve the appropriate conditions for corresponding success. The integration of criteria and procedures in the basin of the Madeira River is essential to ensure the availability of water, quality standards appropriate to their uses, thus ensuring the sustainable use of its supported regional development resources.

5. FINAL CONSIDERATIONS

Recent water scarcity events on the national scene promoted search of proposals for the preservation and rational use of water in Brazil. The problem of lack of water may be linked to climatic and geographical factors, but these do not exclude the irrational use of natural resources and the lack of public policy management on water resources. Thus, this research proposed to study a methodology for the management of hydric resources in support of environmental sustainability on the Madeira River Basin based on the Theory U. For this, it was done a survey of the main informational subsidies for sustainability in the scenario in study, which promoted the theoretical support of this research.

Afterwards, it was done the analysis of the PROGESTÃO, where it was found that current state of Rondônia concerning to the variables control is worrisome, because it only reached the minimum level of requirements set by ANA. As for the actions of planning, the analysis indicates a large negative impact, besides of presenting in the majority of the variables, only the minimum level and exposes its inefficiency in the planning of basin and framing. It was noticed even the state's inability on the implementation of water agencies and delegated entities. Before the analysis of PROGESTÃO it was concluded that Rondônia must assume commitment to effective coordination between the management and control processes in order to overcome common challenges and promote multiple and sustainable use of water resources.

Finally, it was done was the analysis of the procedural innovation proposal based on the Theory U. It was found that the procedural guidelines of PROGESTÃO have the characteristics that satisfy the dynamics of the U theorized. So the PROGESTÃO fits as an innovative methodology for the management of water resources in support of environmental sustainability in the Amazon. Based on the above considerations, it is possible to answer affirmatively the question of the research proposed in this study, which is consistent in identifying a methodology for hydric resources management of the Madeira River Basin. This task is of interest to public officials committed to environmental issues and also in the formulation of integrated and sustainable local development policies.

REFERENCES

- BLOCH, Carter (2010). "Towards a conceptual framework for measuring public sector innovation." Available on:
http://www.nordicinnovation.org/Global/_Publications/Reports/2011/201102_MEPIN_report_web.pdf. Accessed on: 24 nov. 2014
- CURI, Denise (2011). Environmental Management. Pearson Education of Brazil. São Paulo: Pearson Prentice Hall.

- CRESWELL, John W. (2010). *Research Project: qualitative, quantitative and mixed methods*. Porto Alegre: Artmed.
- RONDÔNIA. Decree No. 18.045/2013, Adhesion to the Nacional Pact of Water Management. Available on: <http://www.sedam.ro.gov.br>. Accessed on 12/11/2014.
- LEÃO, João Artur Avelino (2014). “Scientific Innovation for the Institutional Development: Study Case at Federal Institute of Education, Science and Technology of Acre – IFAC.” Dissertation in Administration. Post-graduation - Master Program of the Federal University of Rondônia – UNIR. 133p. Porto Velho: UNIR.
- MATIAS, Francisco. (2010) “Historical and Economical Formation of Rondônia.” Porto Velho: INDAM.
- MOZZATO, Anelise R; GRZYBOVSKI, Denize. (2011) *Content Analysis and Qualitative Data Analysis Technique in the Administration field: Potential and Challenge* Curitiba: ANPAD.
- PROGESTÃO (2013). *Consolidation Program of the National Pact for Water Management, Volume I and II*. Available on: <http://www.sedam.ro.gov.br>. Accessed on 12/11/2014.
- SILVA JÚNIOR, O. da (2010). “Risk Analysis flooding in the city of Alenquer - State of Pará”. Dissertation in Geography. Institute of Philosophy and Human Sciences, Federal University of Pará. Belém: UFPA.
- SCHARMER, Otto (2010). *Theory U: Leading from the Future as it Emerges. (How to lead by perception and realization of the emerging future)*. Rio de Janeiro: (Câmpus Publishing) Editora Câmpus.
- SARKISSIAN, W. (2010). A potential source of new thinking about working at the Edge. Workshop at EAROPH Congress, 3 November. Available on: http://sarkissian.com.au/wp-content/uploads/2013/03/Session-4-Otto-Scharmers-Theory-U-model-EAROPH_FINAL.pdf. Accessed on: Set 10, 2014.

NO.6

The Realization and Verification of Automatic Counting for Traffic Volumn Survey by Utilizing OpenCV

Feiyu Hu^{1*}, Takashi Hashimoto¹, Kensei Nishimoto¹ and Masafumi Naka¹

1 Nihonkai Consultant Co.,Ltd.

** Corresponding Author, Email: h-ko@nihonkai.co.jp*

Key words: OpenCV, Computer Vision, Traffic Volume Survey, Video Detection

Abstract: Traffic infrastructure is one of the most important components of smart city, in this work we tried to verify the utility of observing traffic flow by using video device, then designed and developed a prototype of an automatic counting system for the vehicles and pedestrians. In the purpose of verifying influence on the identification accuracy caused by the overlapping and the size of the passing vehicles captured in the video, several experimental comparisons were conducted based on different camera setting position/angle and weather. Then a prototype system utilizing OpenCV was designed and developed for counting vehicles and pedestrians automatically. OpenCV (Open Source Computer Vision) is a library of programming functions focused on the image and video processing. It is expected that the protection for investigators from traffic accident and the reduction of labour costs can be realized by the application of this system. At present, the tracking and counting for the vehicles passing through the intersection is under confirmation.

1. INTRODUCTION

Traffic infrastructure is one of the most import components of city. In Japan, Road Traffic Census is conducted every 5 years, which is under the administration of Ministry of Land, Infrastructure and Transportation (MLIT), Government of Japan. The purpose of Road Traffic Census is to investigate national road, street traffic situation. And Road Traffic Census is made up of two sub surveys: "General Traffic Volume Survey" (including road condition survey, travel speed survey and traffic volume survey) and "Vehicular Origin-Destination Survey". Traffic volume survey aims to get the essential data for traffic planning, road construction and road maintenance management. The survey time is 12 hours from 7am to 7pm and 24hours only for sections which are required for night time traffic

volume survey.

At present, there are two main methods for traffic volume survey in Japan. One is using simple traffic counter, the infrared sensor or magnetometric sensor are utilized to detect the passing cars. However, the magnetometric sensor counter should avoid being set up to the place where is near to the high-voltage line or iron bridge made of metal. And the application for setting up the traffic counter on the road or road side should be submitted before the survey. Moreover, roadway work for installing the traffic count sensor is also essential. This method is not applicable for counting bicycles or pedestrians.

The other is to count vehicles or pedestrians by hand. Investigators sit on the road sides then count the passing vehicles or pedestrians manually. This method was used more than 2/3 of the total traffic volume surveys in Japan.

The MLIT is currently anticipating several changes in road traffic surveys in the future, (Hashimoto, et al. (2012)) including strengthening daily traffic volume and travel time observation systems by using constant observations (continuous observations) and making maximum use of information communication technologies (ICT) to measure road traffic data.

Considering these changes in the traffic volume survey and the protection for investigators from traffic accident and the reduction of labour cost, the image processing technology (computer vision) for traffic volume survey is expected to be utilized.

The aim of image processing (computer vision) is to help the computer to work like human that could understand the content of an image (features like colours, object shape, texture etc.). With the developing of algorithms for image processing, the function of extracting what happens by processing multiple images of the same sequence or different sequences can be achieved. In order to count the vehicles in a video, first, moving objects should be detected by using image processing technology. Several studies using image processing technology for object detection have been done in the past years.

In Naveen Chintalacheruvu's research (Naveen Chintalacheruvu, Venkatesan Muthukumar (2012)), Harris-Stephen corner detector algorithm was proposed for the vehicle detection in the video. Massimo Piccardi presented that background subtraction is useful for detecting moving objects from static camera. (Massimo Piccardi (2004))

From 2010, Hirotaka Sekiya (Hirotaka Sekiya, et al. (2013)) aimed at devising an optimal method for measuring traffic volume in Indonesia by using image processing technology. Through the field surveys in Indonesia, they verified the applicability of IPT (Image Processing Technology) to traffic volume surveys in Indonesia by revealing that an IPT device (CCTV camera) is superior to the current method used in Indonesia in terms of the accuracy of measuring traffic. In Sekiya's study, a special detection device

(CCTV camera) was utilized, however, whether a general camera for family use also can be utilized for? Without using a special hardware device, a splendid software tool is expected to solve the same problem.

OpenCV (Open Source Computer Vision) is a library of programming functions mainly aimed at the image and video processing, and was designed for computational efficiency and with a strong focus on real-time application ([OpenCV Home Page\(2015\)](#)). It is free for both commercial and non-commercial use. There are some related works focused on traffic volume survey by using OpenCV have been done.

Nilesh J Uke, and Ravindra C. Thool ([Nilesh J Uke, Ravindra C. Thool \(2012\)](#)) designed and implemented a system with OpenCV for highway traffic counting. In 2014, Nilesh J Uke([Nilesh J Uke, et al.\(2014\)](#)) also proposed a OpenCV based method for traffic sign detection recognition and tracking based on the colour and shape of the road sign and its geometric attributes. Reena Gokule ([Reena Gokule, Amit Kulkarni \(2014\)](#)) in his study estimated vehicle speed using OpenCV on video streams and detected a stationary vehicle on the road.

Based on the previous works, the purpose of this paper is to design and develop a prototype system for detecting/counting vehicles and pedestrians automatically, and this kind of method is also expected could be utilized in Japanese traffic volume survey not only for the highway but also for the road/street in the city, then try to verify the system utility and find the factors that influence the accuracy. It is expected that the applicability of this system could protect investigators from traffic accident and reduce the labour cost for traffic volume survey.

2. RESEARCH APPROACH

As mentioned in the introduction, this research is about the prototype system development and utility verification for traffic volume survey.

In order to develop this system, OpenCV is used as a key tool to detect moving objects from a video then classify the captured objects into vehicles and pedestrians. In this work we applied the background subtraction method presented in Massimo Piccardi's previous research ([Massimo Piccardi \(2004\)](#)) for detecting moving objects from static camera. After the moving objects captured from the video stream, these objects were classified into vehicles or pedestrians by Haar feature-based cascade classifier.

A cascade of boosted classifiers working with haar-like features is trained with a few hundred sample views of a particular object, called positive examples, that are scaled to the same size and negative examples-arbitrary images of the same size. After a classifier is trained, it can be applied to a region of interest in an input image.([OpenCV Document\(2015\)](#)) The features of the particular object (classifier) can be loaded from XML.

The classifier named “cars3.xml” used in this work for vehicle detection was downloaded from internet, not defined by ourselves. ([Google Code \(2015\)](#)).

After finished the automatic counting system development, the next step is to verify the applicability in the real road/street condition for traffic volume survey. In the purpose of confirming what factors influence the detection accuracy, several experimental comparisons based on different camera settings (position/angle etc.) were conducted. In the process of analysing the automatic counting results, we tried to minimize the error by the modification of parameter settings. The detection accuracy is expected at 90% at least.

In the last step, it is expected that the system could reduce the labour cost in the survey with the high detection accuracy. Generally, 2 investigators at least are essential for one survey, sometimes the total number of investigators is more than 200, and the cost is at 1000 Japanese yen person/hour. If the automatic detection and counting method could be utilized, we also need to verify how much cost could be saved.

3. SYSTEM DESIGN

In this section, we described the components of the detection system, OpenCV library is used for computer vision applications, Pycharm IDE and Python language is used for programming. The video was captured using the general digital camera (GAUDI GHV-DV30HDAK) for family use.

3.1 System framework

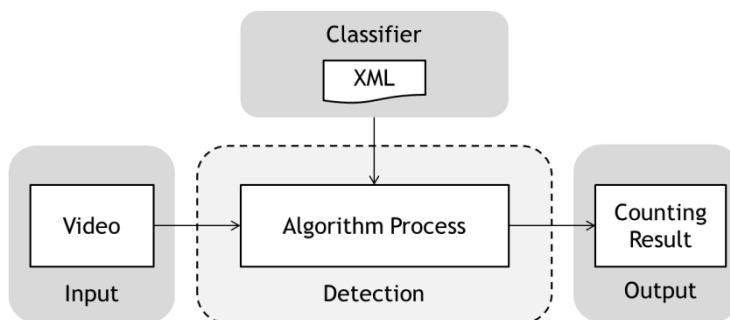

Figure 1. System framework

Figure 1 is about the system framework, which shows the architecture of the I/O parts and the computer vision processing and the reference classifier file (XML).

The output (result) here is not the actual number of the total vehicles or

the pedestrians. The result is an image file (with a frame number as its file name) which was captured and saved at the moment that object was detected as a moving object, moreover, if the object is classified as a car or pedestrian, the system will also save the image at the same time into a new file as what it was classified.

3.2 System flowchart

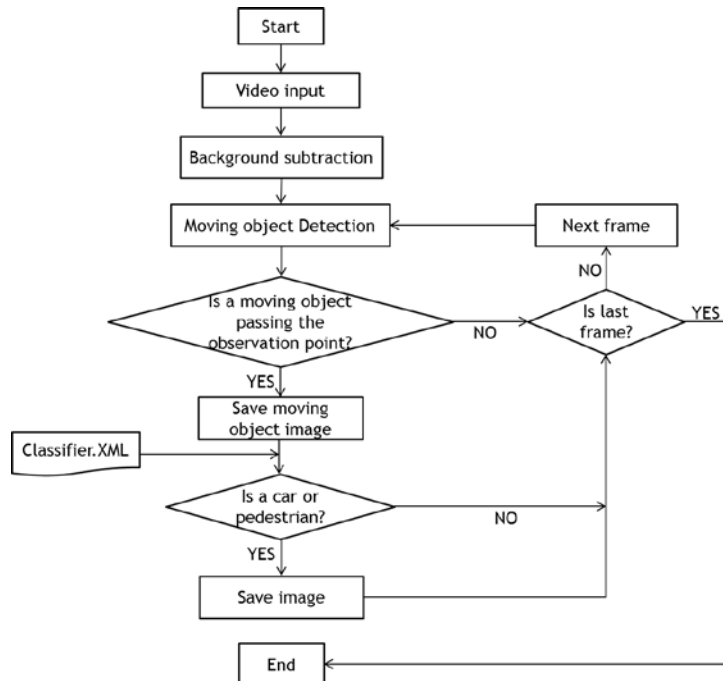

Figure 2. System flowchart

Figure 2 shows the flowchart of the system. The algorithm in this system detects the moving objects from each frame of the video, if the object passes the detection point set up on the video screen, the object image would be saved. In the consideration that the same object passes the detection point in several continuous frames on its moving route, the algorithm is also designed to prevent multiple counting for the same object. Furthermore, the moving object extracted from the frame is classified by classifier XML file. The result analysis process will be conducted after the result output by analysing image files' name (frame number) and total image files' amount.

4. COMPARISONS AND ANALYSIS

4.1 Comparison at different angles

In order to confirm the system utility and counting result accuracy, firstly, a video for traffic volume survey is necessary. In February 2015, an on-site survey was conducted on a city road in Kanazawa City, Japan. We installed three cameras at 3 different angles (10, 20, 30 degrees) on a footbridge at the height of 6m from the ground to observe vehicles of 4 lanes (2 up lanes and 2 down lanes). And the observation time was 1 hour. *Figure 3* shows the installed cameras on the bridge.

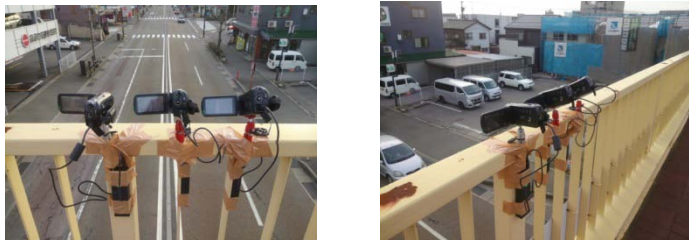

Figure 3. Cameras installed on the foot bridge

Figure 4 is the image screen of each camera at different setting angles.

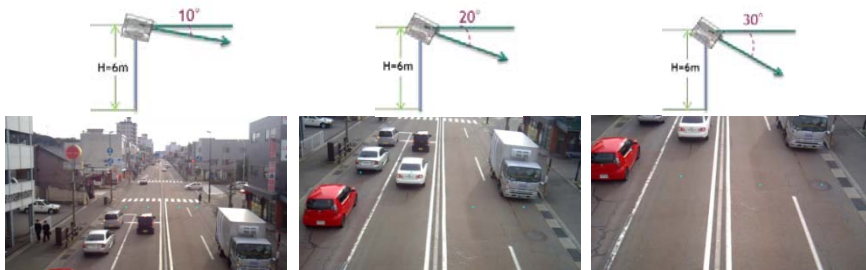

Figure 4. Image screen of each camera at different setting angles

4.2 Result and analysis

4.2.1 Detection of moving objects

We measured the traffic volume from the images captured from the video of on-site traffic survey. One point used for detecting vehicles was set up on camera screen for each lane. Table 1 is the original results counted by image processing and manual counting.

Table 1. Original counting results

	Manual Counting	Video Counting (Moving Object)		
		Angle: 10°	Angle: 20°	Angle: 30°
Up Lanes	494	775	642	605
Down Lanes	596	819	662	642

From this table, we can find that the automatic counting result is totally different from the manual counting result. By analysing the images one by one, it got clear that several cars were counted multiple times. Although we had prevent to count the same car twice or more times in the algorithm, for some cars, especially the large-sized car (truck and bus) ,the larger the car is, the more possibility of errors (multiple counting) happens. For the cars stopped at the traffic signal, the algorithm prevention also didn't work well.

Referring to the Standard Following Distance Table 2 published by Metropolitan Police Department (Automobile traffic instruction (1958)), we supposed that generally it is impossible that two cars can pass the same place point in 1.3 second, which means if vehicle is detected several times in 1.3 second, it is counted only once. Here, the 1.3 second is the average passing time of Table 2.

Table 2. Standard Following Distance (Reference: Automobile traffic instruction within the jurisdiction of Metropolitan Police Department)

Speed(km/h)	Following Distance(m)
55	20
50	18
45	17
40	15
35	13
32	10
30	9
25	8
20	6
15	5
10	4
8	3

Table 3 shows the counting results after revision, the total number counted automatically comes close to the real number counted manually.

Table 3. Counting results after revision

	Manual Counting	Video Counting (Moving Object)					
		Angle: 10°		Angle: 20°		Angle: 30°	
		Amount	Accuracy	Amount	Accuracy	Amount	Accuracy
Up Lanes	494	492	99.6%	522	94.3%	517	95.3%
Down Lanes	596	574	96.3%	602	99.0%	611	97.5%

Based on the result of Table 3, whether we can believe that the accuracy of Up Lanes at the camera angle 10 degrees is as almost perfect as 99.6%? In the previous related works as mentioned in the introduction section, the accuracy was only compared by traffic volume counted manually and traffic volume counted by image processing. However, besides the problem of multiple counting (error), is every vehicle really detected by the method of image processing?

In order to confirm this problem, we compared all the detected vehicles to the original video. The result is listed as following.

Table 4. Comparison of real detected moving objects and the camera counting results

	Manual Counting	Moving Object					
		Angle: 10°		Angle: 20°		Angle: 30°	
		Real detected	Video Counting (after revision)	Real detected	Video Counting (after revision)	Real detected	Video Counting (after revision)
Up Lanes	494	479	492	488	522	494	517
Down Lanes	596	592	574	595	602	596	611

From Table 4, all the moving objects can be detected only in the condition of camera setting at 30 degrees, in other words, the counting results of 10 degrees and 20 degrees are not as correct as their total number apparent because some moving objects were not detected as we expected. It can be found from the camera screen that in the condition of setting angle at 10 degrees and 20 degrees, the possibility of overlapping of vehicles is more than 30 degrees for the following distances between vehicles are shorter on the screen than angle settings at 30 degrees. Thus some vehicles are overlapped by others on the screen cannot be detected.

Therefore, the accuracy ratio of this automatic counting system is defined in Equation (1).

$$\text{Accuracy ratio} = \frac{V_{real}}{V_{manual}} \times \left(1 - \frac{|V_{real} - V_{camera}|}{V_{real}} \right) \quad (1)$$

Where, V_{real} : traffic volume really detected from video
 V_{camera} : traffic volume counted automatically from video
 V_{manual} : traffic volume counted manually

Table 5 shows the counting accuracy of each camera setting angle calculated through the Equation (1). Obviously, excepting the accuracy ratio of angle setting at 30 degrees, other accuracy ratios are not at a high accuracy level as before.

Table 5. Comparison of accuracy ratio of each camera setting angle

	Moving Object Detection Accuracy		
	Angle: 10°	Angle: 20°	Angle: 30°
Up Lanes	94.3%	91.9%	95.3%
Down Lanes	96.2%	98.7%	97.5%

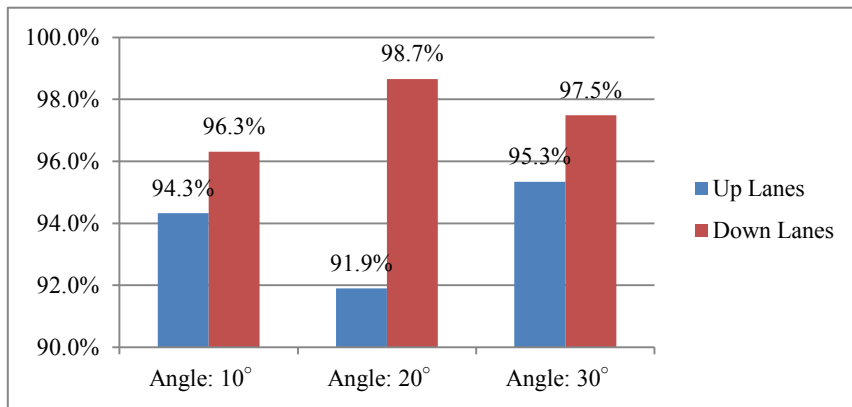

Figure 5. Accuracy ratio of each setting angle

As shown in *Figure 5*, the counting accuracy of down lanes is higher than up lanes no matter how the camera angle setting changed. Through the analysing of captured moving object images from the video, we can find that because of the stopping at the traffic signal, it is prone to count the same object twice or more. Although we have already used the algorithm method to prevent this kind of problem, however, it only had good effect on the condition that vehicles pass the detection point with few stopping just like the traffic on the down lanes in this research video, for the traffic on the up lanes, this algorithm method didn't work as well as it did for the down lanes. We considered the main reason is that because the cars restart after the stopping at the traffic signal, it would be recognized as a new moving object and detected by OpenCV. Thus, with the influence of traffic signal, we can understand why the automatic accuracy of down lanes in each detection angle is better than the up lanes. Based on this result, it can also

be assumed that automatic counting accuracy in the condition of congested traffic is not as good as the condition of not congested traffic.

It also can be seen from *Figure 5*, in the condition of camera setting height at 6m, the highest accuracy is 98.7% at the angle of 20 degrees for down lanes. In contrast, the accuracy ratio for the up lanes at the same angle of 20 degrees is the worst of all at 91.9%. We considered that the main reason is also the stopping at the traffic signal caused multiple counting errors by OpenCV, and then lead to the comparatively less accuracy result. And for different camera setting angles (road visible range changed by angles on the screen), the traffic signal influences the result in different extents.

Although in the condition of camera setting at 30 degrees can detect all the moving objects, due to the size of large-size vehicles, the same object would be counted by the neighbour lane detector like *Figure 6*. For down lanes, the setting angle of 20 degrees is better to others, because of its high real object detection ratio and less multiple counting errors (including less errors of overlapping of vehicles counting and neighbour lane's moving object counting).



Figure 6. Multiple counting for the same vehicle at the angle setting of 30 degrees (left: detected by the left down lane; right: detected by the right lane again)

4.2.2 Detection of Vehicles

From the previous section, we already verified the accuracy of automatic counting method, and the accuracy ratio is 91.9% at least.

In this section we checked recognition of vehicles from the captured images of moving objects. The following is about the recognition ratio of each setting angle for up and down lanes.

Table 6. Comparison of vehicle recognition

	Moving Object								
	Angle: 10°			Angle: 20°			Angle: 30°		
	Real detected	Vehicle recognition	Ratio	Real detected	Vehicle recognition	Ratio	Real detected	Vehicle recognition	Ratio
Up Lanes	479	375	78.3 %	488	444	91.0 %	494	290	58.7 %
Down Lanes	592	396	66.9 %	595	543	91.3 %	596	349	58.6 %

As shown in Table 6, it is clear that the up and down lanes' vehicle recognition ratios in the condition of angle setting at 20 degrees are more than 90% and much higher than 10 degrees and 30 degrees. After compared the same car's images in different videos, in fact here we considered that this result caused by not only the problem of camera setting angle but also the extracted image content (vehicle's size in the image, and the padding in the image is not any part of car).



Figure 7. The images extracted from videos of different camera angles for the same car

In contrast of the images in Figure 7 (the green point in the image is used for object detection), besides the image's size, the shape of the car is also easily to be recognized by OpenCV in the condition of 20 degrees camera setting.

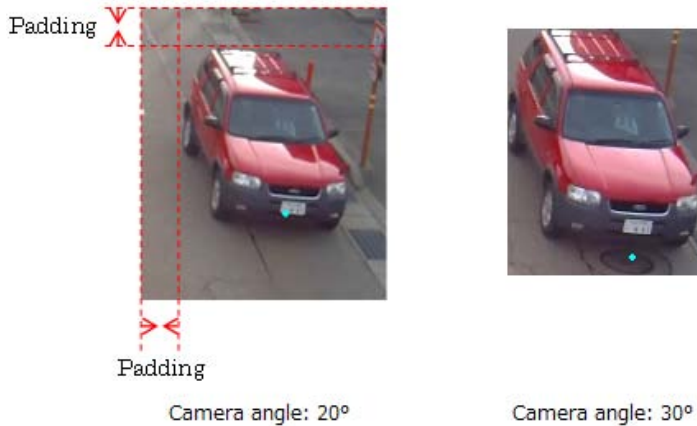

Figure 8. The images extracted from videos of different camera angles for the same car

Obviously, in *Figure 8*, the image size of the car at camera angle 30 degrees is bigger than 20 degrees. However, without the padding space in the image, sometimes due to the limitation of OpenCV, although the shape of car in the extracted image is clear enough, it still cannot be recognized. The problem could be solved by adding padding space, the padding space can be modified in the programming process, but for the camera angle of 30 degrees, as the screen is almost full of 4 lanes, there is no enough space could be filled in the image because it would cause the error counting for the neighbour lane.

4.2.3 Unexpected conditions

In traffic volume survey, sometimes unexpected conditions happen, such as traffic accident, vehicle fault, emergent incident and so on. Errors caused by these reasons can be immediately detected by counting manually. And some unexpected conditions only happen in several seconds or minutes are hard to be found, so these unexpected conditions also influence the result of counting automatically from a video. In the video of this work, several unexpected conditions (*Figure 9*, *Figure 10*) happened, and they also led to the counting errors.



Figure 9. Unexpected condition 1(camera angle 10°)



Figure 10. Unexpected condition 2(camera angle 10°)

For these kinds of unexpected conditions, because the detection points changed with the camera angle setting, they only happened in the video of camera angle at 10 degrees. To put it from another way, some unexpected conditions can be prevented by the modification of camera angle setting and the points' position for detection.

5. SUMMARY AND CONCLUSION

The overall goal of this work is to propose a prototype of an automatic counting system by using OpenCV for traffic volume survey, and then verify the relevant factors that influence the accuracy. In order to solve this problem, the video of traffic volume survey is essential.

Ideally, the camera with high resolution should be installed higher up with the angle setting closer to 90 degrees as the vehicles can be seen clearly and the following distance between vehicles seen from the camera screen is enough (no overlapping). However, in fact for real traffic volume survey, there is no such a perfect place for camera to be installed.

In this research, we demonstrated that the optimum angle is 20 degrees for moving object automatic counting (accuracy is 98.7%) at the camera setting height of 6m with the assumption that two cars cannot pass the same place point in 1.3 seconds. However, this result does not mean that it can be applied and bring about the same accuracy for any other traffic conditions. At present, we only conducted the experiments for one hour in the daytime, further studies are necessary to make sure that whether this method can be used for 12 hours survey and the optimum camera setting for different conditions (traffic conditions and camera setting condition, including the camera setting height, position etc.).

Besides, we found that for the same camera angle setting, the accuracies of up and down lanes were totally different because of the influence of traffic signal. This kind of movement that vehicles stop at the traffic signal and then restart causes the multiple counting errors by OpenCV. It also can be assumed that for the congested traffic flow, the accuracy of automatic counting result is not as good as the uncongested traffic flow.

For the vehicle recognition, by analysing the captured vehicles' images, it is obvious that the accuracy of camera angle at 20 degrees is much better than 10 degrees and 30 degrees in the case of camera setting height at 6m. We deemed that the errors generated by vehicles' size or shape is small and not clear enough for OpenCV to recognize in the condition of camera angle at 10 degrees. And the padding space is hard to extract from the camera screen that lead to the low vehicle recognition ratio in the condition of camera angle at 30 degrees due to the OpenCV's function limitation.

Although we conducted the experiment not for all possible traffic conditions, at least we can say this method is applicable for some conditions in which the accuracy is higher than 91%, and the relevant influence factors were also analysed. This research can be considered as a useful attempt for the traffic volume survey in Japan.

6. FUTURE WORK

As described in the summary section, this study still has several limitations.

In the future, the first work should be conducted is to apply this system in other traffic conditions such as night time and congested traffic condition. The system's accuracy and utility are needed to be verified for as many as different conditions. And not only for vehicles but also for pedestrians can be detected and recognized.

Further, the development of an image search engine is essential to distinguish the multiple counted vehicles from the captured images as now we only revised the result with the assumption that two cars cannot pass the same place point in 1.3 seconds in general. This kind of image search engine also can be realized by OpenCV. And with the modification of detection processing algorithm, we hope that these two methods will bring about a higher accuracy for the automatic counting result.

In addition, the most difficult location of spot for traffic volume survey is road intersection. The vehicle amount of turning left, go straight and turning right should be counted separately for each intersection. However, the algorithm now used in our system cannot solve this problem. It is expected that the counting problem for intersection could be coped with the method of tracking vehicles, thus vehicle amount can be counted for each direction.

We hope the developed system will be utilized in Intelligent Transportation System in the future due to its comprehensive moving object behaviour data collection capabilities.

REFERENCES

- Hiroyashi Hashimoto, et al. (2012). "New development of road traffic survey in japan: from once every five years to 24/7", 19th ITS World Congress, Vienna, Austria, 22/26 October 2012.
- Naveen Chintalacheruvu, Venkatesan Muthukumar (2012). "Video Based Vehicle Detection and Its Application in Intelligent Transportation Systems", *Journal of Transportation Technologies*, 2012,2, 305-314.
- Massimo Piccardi (2004). "Background subtraction techniques: a review", *IEEE International Conference on Systems, Man and Cybernetics 2004*, 3099-3104.
- Hiroataka Sekiya, et al. (2013). "Application of Image Processing Technology to Traffic Volume Survey in Indonesia: Joint Study between National Institutes in Indonesia and Japan", *Proceedings of the Eastern Asia Society for Transportation Studies*, Vol.9. 2013.
- OpenCV Home Page. URL:<http://opencv.org/> (March 1,2015)
- Nilesh J Uke, and Ravindra C. Thool (2012). "Moving Vehicle Detection for Measuring Traffic Count Using OpenCV." *4th International Conference on Conference on Electronics Computer Technology (ICECT 2012)*. 2012.

Infrastructure & Transportation Planning

- Nilesh J Uke, et al. (2014). "A Vision based Driver Support System for Road Sign Detection." *International Journal on Recent Trends in Engineering & Technology* 10.1, 2014.
- Reena Gokule, Amit Kulkarni (2014), "Video Based Vehicle Speed Estimation And Stationary Vehicle Detection", *International Journal of Advance Foundation and Research in Computer (IJAFRC)*. Volume 1, Issue 11, November 2014.
- OpenCV Document.
URL:http://docs.opencv.org/modules/objdetect/doc/cascade_classification.html (March 1,2015)
- Google Code, URL <https://code.google.com/p/opencv-lane-vehicle-track/source/browse/trunk/bin/haar/cars3.xml?r=2> (March 1,2015)
- Automobile traffic instruction under the jurisdiction of Metropolitan Police Department Japan. URL: <http://dl.ndl.go.jp/info:ndljp/pid/1351411>

NO.13

Sparse Link Travel Time Estimation Using Big Data of Probe Vehicle

FamingZhang^{2*}, Wei Guo², Yi Liu¹, Jingwei Zhu³ and Tao Hu²

1 School of Geodesy and Geomatics, Wuhan University

2 State Key Laboratory of Information Engineering in Surveying, Mapping and Remote Sensing, Wuhan University

3 School of Remote Sensing and Information Engineering, Wuhan University

** Corresponding Author, Email: zhang.fa.ming@163.com*

Key words: big data of probe vehicle, sparse link, relationship of features, artificial neural network, link travel time estimation

Abstract: Many research efforts based on model using the probe vehicle data to estimate travel time have been made on travel time prediction. Those proposed models need abundant known data to estimate link travel time. However, when there isn't enough data, namely sparse data, the existing methods based on model cannot efficiently infer link travel time under the condition of sparse data.

In view of the disadvantage of existing methods in estimating link travel time in the condition of lacking abundant data, we put forward a kind of inferred method based on big data of probe vehicle and feature correlation between target link and adjacent link. The method we proposed mainly has the following two aspects of innovation. First, we made data aggregation from Monday to Friday respectively according to travel time of single taxi traveling target link on working days because traffic flow presents a similar trip patterns every week, namely week's cycle. Then, we extracted feature relationships between target link and adjacent link at the same time period based on big data of probe vehicle data. All these extracted features are as the input and output of neural network model. Second, we designed a three-layer artificial neural network model. The number of neuron in input layer is designed for six and the number of neuron in output layer is one. We used the designed artificial neural network model for training, validation. Finally, the trained neural network model was used for link travel time inference. The model was verified by historical big data of probe vehicle during June and July, 2014. The experimental results showed that under the condition of sparse data, based on the acquired feature relationships between target link and adjacent link according to the historical big data, we could obtain better results using the designed artificial neural network model.

1. INTRODUCTION

The estimation and prediction of travel time in urban road networks are challenging aspects because of the intrinsic uncertainty of travel time of which probe vehicle traverse target link of road network. This is produced by fluctuations in traffic demand and affected by many other factors, such as traffic demand (e.g. due to population characteristics, seasonal effects, time instant, behavior of driver, traffic information and user responses) and traffic control, supply (e.g. due to incidents, road works, road geometry), weather conditions (e.g. due to temperature, rain, snow, wind), stochastic arrivals and departures at signalized intersections (Liu et al., 2009), the direction of traffic flow, etc. Traditionally, loop detectors have been used to collect traffic data reflecting traffic state. And many models have been developed to estimate or predict travel times based on existing loop detector data (Oh et al., 2003; Van Lint and Van Der Zijpp, 2003; Van Lint et al., 2005; Kwon and Petty, 2005; Liu et al., 2006, 2007). However, installing loop detectors everywhere in urban city which provide abundant traffic monitoring information is not reality. At the same time, maintaining those devices of city is also quiet expensive. Probe vehicles equipped with GPS as mobile traffic sensors are being used to collect network-wide traffic data. Probe vehicles can collect information such as instantaneous speeds, timestamp, latitude and longitude coordinates and azimuth, reflecting the running state of the urban traffic, which plays an important role in the city road network real-time or near real-time travel time estimation.

At present, there have been many methods based on model using the probe vehicles data to estimate travel time. Jula et al. (2008) proposed a mathematical model to estimate travel time along the arcs and arrival time at the nodes of a stochastic and dynamic network in real time. And a predictor–corrector form of Kalman filter was developed to estimate the travel times along that arc for future times. Zheng et al. (2013) proposed a three-layer neural network model to estimate complete link travel time for individual probe vehicle traversing the link. The model was discussed and compared with an analytical estimation model which was developed by Hellinga et al. (2008). But, models were evaluated with data derived from VISSIM simulation model, not considering real GPS data which reflects real traffic flow. Liu (2009) proposed a model to estimate arterial travel time by tracing a virtual probe vehicle along an OD route with multiple intersections. The model works quite well with very low estimation error of 1.8%. Jenelius et al. (2013) presented a statistical model for urban road network travel time estimation using vehicle trajectories obtained from low frequency GPS probes as observations. The network model separated trip travel time into link travel time and intersection delays and allowed correlation between travel times on different network links based on a spatial moving average (SMA) structure. Zhan et al. (2013) developed a

methodology to estimate link travel time from OD trip data and demonstrated the feasibility of estimating network condition using large-scale geo-location data with partial information. The existing model estimated the travel time of link or trip under the condition of the sufficient GPS data. However, the existing method based on model cannot efficiently infer link travel time under the condition of sparse data (Zheng et al., 2011; Zheng et al. 2013; Herring R et al., 2010). However, due to the low frequency (Wang Y et al., 2014; Li J, 2012; Yao et al., 2013) of taxi GPS data acquisition and the regional limitation of driving area, the trajectory information collected by taxi GPS can't cover all urban road network. So, data collected are sparse (Zheng et al., 2011; Zheng et al. 2013). How to infer link travel time using sparse data is a problem to be solved.

In view of the data sparseness, we put forward a three-layer neural network model based on feature relationship between link and adjacent link and used the model to infer the link travel time. For each link, day, time, degree ratio and length ratio between target link and adjacent link, speed expectation and speed standard variance among adjacent link are as ANN (Artificial Neural Network) input. Travel time ratio between target link and adjacent link are as ANN output. The experimental results shows that the neural network model proposed can use relationship between target link and adjacent link to infer link travel time, solving the problem that cannot estimate link travel time due to data sparseness.

2. FEATURE EXTRACTION

As is known to all, time, speed expectation and speed standard deviation, link degree and link length is closely related to road traffic flow characteristics. Due to the effect of GPS positioning error (Chen Wen, 2011), GPS point tends to deviate from the actual road of probe vehicle travel. Therefore, these GPS points which deviate from the true road should be first projected to the road probe vehicle running and then link travel time of single probe vehicle could be calculated using these corrected point.

In this paper, probe vehicle trajectory was matched by map matching algorithm (Chen et al., 2014; Yuan et al., 2010; Zhang et al., 2013; Li et al., 2013) and we calculated travel time and average speed of taxi traversing target link considering the taxi running state at intersection (Yu et al., 2010; Dong et al., 2009; Jiang et al., 2009). Consequently, we extracted features of target link and adjacent link from quantity of statistical travel time of taxi traversing target link.

Figure 2 shows the study area of Wuhan road network, which presents link number distinguishing different link. Existing researches have proved that the taxi trajectories presented similar traffic patterns for week's cycle (Fei X et al., 2011; Liu X et al., 2013). Obviously, the traffic flow of

different direction is different and the same direction traffic flow of adjacent link has an important significance on each other. Therefore, we extracted features of target link and adjacent link according to week's cycle and traffic flow direction as depicted Figure 3.

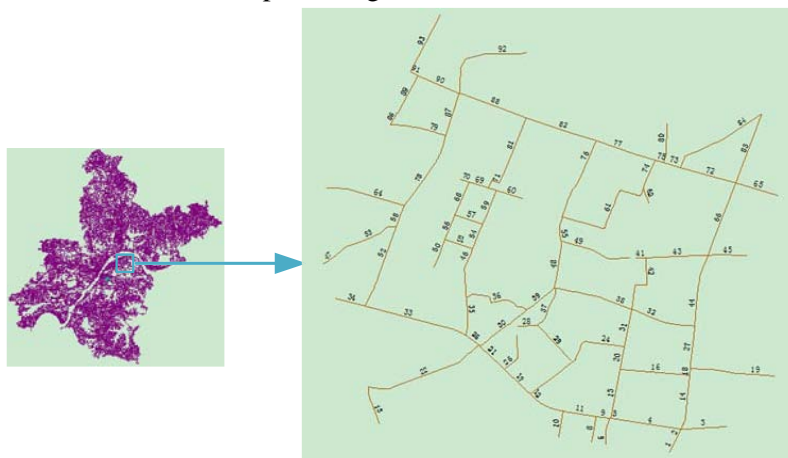

Figure 2. Study area of Wuhan road network

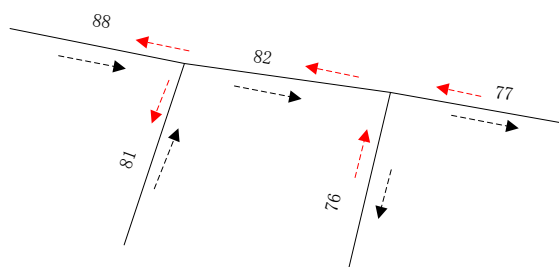

Figure 3. Schematic diagram of traffic flow

2.1 Traffic-related features

In general, speed expectation and speed standard deviation reflect the feature of link traffic and the two features exists some certain correlation respectively between target link and adjacent link. As shown in Figure 3, we should extract link traffic features in accordance with the direction of traffic flow. The traffic flow of black arrow direction of link 81 and link 88 has an effect on traffic flow of link 82 whose direction is black arrow direction. And, the traffic flow of link 82 whose direction is black arrow direction also has influence on the traffic flow of link 77 and link 76 whose direction is also black arrow direction. At the same time, that the traffic flow is red arrow direction also influences each other. Therefore, we extracted speed

expectation and speed standard deviation of link every half an hour according to the traffic flow direction. Here, l denotes link length, t_i denotes travel time of the i th taxi traversing link, v_i denotes average speed of the i th taxi traversing link, $E(v)$ denotes speed expectation of taxi traversing link, and $D(v)$ denotes speed standard deviation of taxi traversing link.

1. Expectation of speed: $E(v)$.

We calculated average speed of single taxi traversing link according to Equation 1. As the travel time of every taxi through link is different, we computed the expectation of speed according to Equation 2 during half an hour, which denotes the overall travel speed of taxi.

$$v_i = l / t_i \tag{1}$$

$$E(v) = \sum \left(v_i \cdot \frac{t_i}{\sum t_i} \right) \tag{2}$$

2. Standard deviation of speed: $D(v)$.

We calculated standard deviation of speed according to Equation 3 during half an hour, which reflects how variably different taxis were traveling link in the past half an hour.

$$D(v) = \sqrt{\sum \left([v_i - E(v)]^2 \frac{t_i}{\sum t_i} \right)} \tag{3}$$

Figure 4 is a line chart reflecting the relationship of speed expectation between link 82 and adjacent link 88. As we can know from the line chart, the speed expectation of link 82 increases when speed expectation of adjacent link 88 increasing, which presents positive correlation.

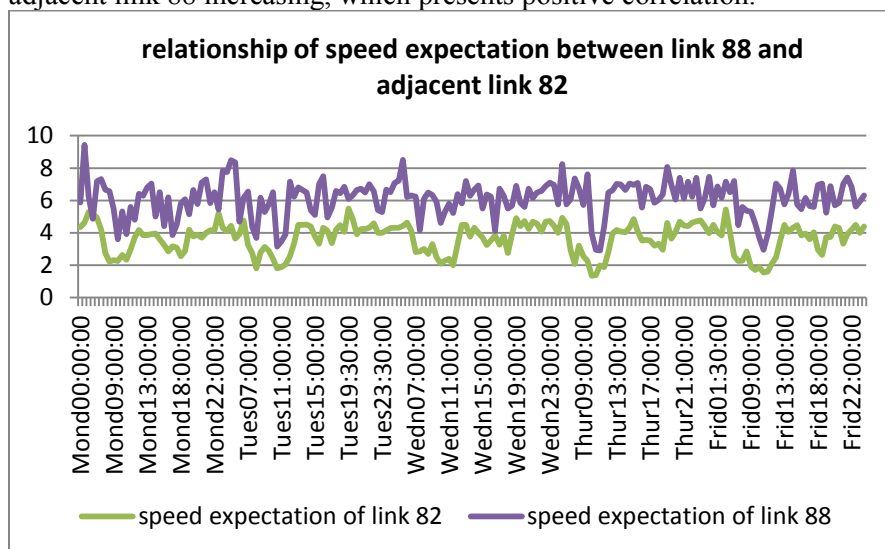

Figure 4. The relationship of speed expectation between link 88 and adjacent link 82

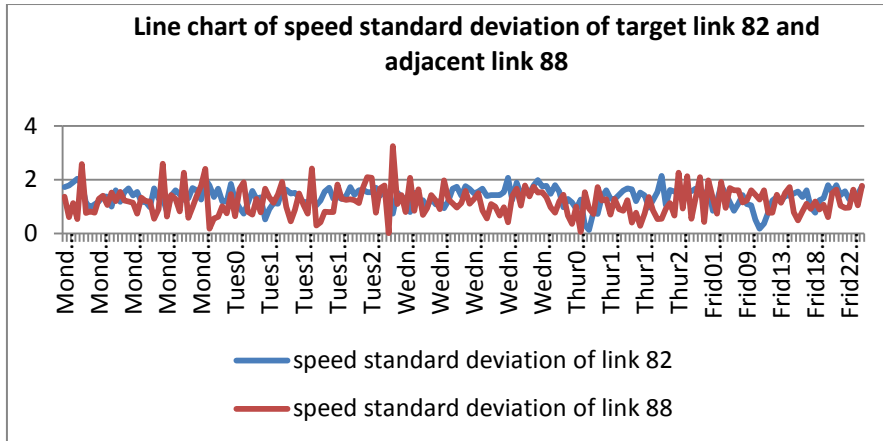

Figure 5. Line chart of speed standard deviation of target link 82 and adjacent link 88

Figure 5 reflects the speed standard variance of link 82 and link 88 respectively. As depicted in figure, that presents a smaller standard variance of speed when most taxis run at the slow speed during rush hour. On the contrary, there exists a large variance when taxis travel with quite different speeds.

2.2 Degree ratio between target link and adjacent link

Connectivity degree of link, denoted by l_{deg} , is the sum of several links attached directly to the two endpoints of link. The greater the degree is, the more the link directly connected with. Therefore, the link guidance capacity of traffic is stronger. We calculated degree ratio between target link and adjacent link in study region according to Equation 4 as neural network input information.

$$\Delta R(deg)_{ta} = \frac{Degr_t}{Degr_a} \quad (4)$$

2.3 Length ratio between target link and adjacent link

Generally, link travel time is affected by target link length and the adjacent link. And the greater the distance is, the longer the travel time of taxi traversing link is. There exists a certain relationship of link travel time between link and adjacent link. We calculated length ratio between target link and adjacent link in study region according to Equation 5 as neural network input information.

$$\Delta R(leng)_{ta} = \frac{leng_t}{leng_a} \quad (5)$$

2.4 Time instance feature.

Considering the different traffic conditions in different time and link transportation presenting a similar characteristic for weeks' cycle (Fei X et al., 2011; Liu X et al., 2013), therefore, we ignore the differences between weeks and consider the differences between days during a week. So, which day during a week and which half an hour during a day are as neural network input information.

2.5 Travel time ratio between target link and adjacent link

Generally, link travel time reflects the traffic running state of link in a way and there exists a certain relationship of link travel time between link and adjacent link. We calculated travel time ratio between target link and adjacent link in study region according to Equation 6 as neural network output information.

$$\Delta R(travT)_{ta} = \frac{travT_t}{travT_a} \quad (6)$$

From the above, we have designed an algorithm which extracted features between target link and adjacent link. The pseudo code of feature extraction algorithm was described as following.

Algorithm 1: Feature Extraction Algorithm

Input: records // travel time records of single prove vehicle
Output: Lwd , Lwh , LR_{deg} , LR_{len} , LE_v , LSD_v , LR_{travT} //they are list of features, which day of a week, which half an hour of a day, degree ratio and length ratio between target link and adjacent link, speed expectation and speed standard deviation of adjacent, travel time ratio between target link and adjacent link.

Parameters: LR_{mon} , LR_{tue} , LR_{wed} , LR_{thu} , LR_{fri} //intermediate variables: list of travel's information in Monday, Tuesday, Wednesday, Thursday and Friday respectively

- 1: for each $Rc \in records$ do
- 2: if ($Rc.dt == t_{Monday}$) then //if the day of record is Monday, it is added to list LR_{mon} .
- 3: $LR_{mon}.add(Rc)$;
- 4: End if
- 5: if ($Rc.dt == t_{Tuesday}$) then
- 6: $LR_{tue}.add(Rc)$;
- 7: End if
- 8: if ($Rc.dt == t_{Wednesday}$) then

```

9:   LRwed.add(Rc);
10: End if
11: if (Rc.dt == tThursday) then
12:   LRThu.add(Rc);
13: End if
14: if (Rc.dt == tFriday) then
15:   LRFri.add(Rc);
16: End if
17: End for
18: ListLR.add(LRmon); // add list LRmon to list ListLR
19: ListLR.add(LRtue);
20: ListLR.add(LRwed);
21: ListLR.add(LRThu);
22: ListLR.add(LRFri);
23: LTime = divideDayTimeByHalfHour(); // divide a day into forty-eight
    half hours
24: For each  $l_t \in LL_{link}$  do // each link in list of link
25:    $len_t = obtainLength(l_t)$ ; //obtain the length of target link
26:    $deg_t = obtainDegree(l_t)$ ; //obtain the degree of target link
27:    $LA_{adjcl} = obtainAdjacentLink(l_t)$ ; //obtain adjacent links of  $l$ 
28:   For each  $l_a \in LA_{adjcl}$  in// every link in list of adjacent link
29:      $len_a = obtainLength(l_a)$ ; // obtain the length of adjacent link
30:      $deg_a = obtainDegree(l_a)$ ; // obtain the degree of adjacent link
31:     For each  $time \in LTime$ 
32:        $startT = obtainStartTime(time)$ ; // obtain start time
33:        $endT = obtainEndTime(time)$ ; // obtain end time
34:       For each  $LR \in ListLR$  do // obtain list of records in Monday or
    Tuesday, Wednesday, Thursday, Friday
35:          $(wd, wh) = obtainTimeInput(startT, endT)$ ; //obtain which day in a
    week, which half an hour in a day
36:         If  $(l_t.enterID == l_a.exitID)$  then //it means the same direction of
    target link and adjacent link from enter node to exit node
37:            $(expe_a, sdev_a, R_{travT}) = obtainInputInfosInTime(LR, startT,$ 
     $endT, l_t.enterID, l_a.enterID)$ ; //obtain speed expectation of link  $l_a$ ,
    speed standard deviation of link  $l_a$ , travel time ratio of target link and
    adjacent link between star time and end time
38:           Lwd.add(wd); Lwh.add(wh);
39:           LRdeg.add(Rdeg); LRlen.add(Rlen); LEv.add(Ev);
40:           LSDv.add(SDv); LRtravT.add(RtravT);
41:            $(expe_a, sdev_a, R_{travT}) = obtainInputInfosInTime(LR, startT,$ 
     $endT, l_t.exitID, l_a.exitID)$ ; // another direction
42:           Lwd.add(wd); Lwh.add(wh);
43:           LRdeg.add(Rdeg); LRlen.add(Rlen); LEv.add(Ev);
44:           LSDv.add(SDv); LRtravT.add(RtravT);
45:         End if

```

```

46:   If ( $l_t$  .enterID ==  $l_a$  .enterID) then // it means the opposite
      direction of target link and adjacent link
47:     ( $expe_a$ ,  $sdev_a$ ,  $R_{travT}$ ) = obtainInputInfosInTime(LR, startT, endT,
 $l_t$  .enterID,  $l_a$  .exitID);
48:     Lwd.add(wd); Lwh.add(wh);
49:     LRdeg.add( $R_{deg}$ ); LRlen.add( $R_{len}$ ); LEv.add( $E_v$ );
50:     LSDv.add( $SD_v$ ); LRtravT.add( $R_{travT}$ );
51:     ( $expe_a$ ,  $sdev_a$ ,  $R_{travT}$ ) = obtainInputInfosInTime(LR, startT,
endT,  $l_t$  .exitID,  $l_a$  .enterID); // another direction
52:     Lwd.add(wd); Lwh.add(wh);
53:     LRdeg.add( $R_{deg}$ ); LRlen.add( $R_{len}$ ); LEv.add( $E_v$ );
54:     LSDv.add( $SD_v$ ); LRtravT.add( $R_{travT}$ );
55:   End if
56: End for
57: End for
58: End for
59: End for

```

3. ARTIFICIAL NEURAL NETWORK MODEL

Though many ANNs can be applied to our framework, we chose the widely-used Back-propagation (BP) neural network with one hidden layer in the experiments for its simplicity and generality. As shown in Figure 6, we set six neurons in the input layer and the number of neuron in output layer was designed for one.

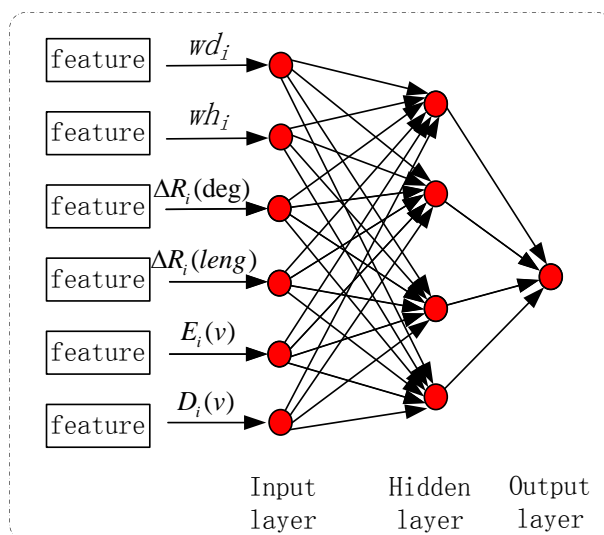

Figure 6. Model structure of BP neural network

3.1 Input layer

$$x_i = \begin{bmatrix} wd_i \\ wh_i \\ \Delta R_i(\text{deg}) \\ \Delta R_i(\text{leng}) \\ E_i(v) \\ D_i(v) \end{bmatrix} \quad (7)$$

where x_i denotes the i th vector of input layer; wd_i denotes which day of a week; wh_i denotes which half an hour of a day; $\Delta R_i(\text{deg})$ denotes degree ratio between target link and adjacent link; $\Delta R_i(\text{leng})$ denotes length ratio between target link and adjacent link; $E_i(v)$ denotes speed expectation of adjacent link; $D_i(v)$ denotes speed standard deviation of adjacent link. It is worth noting that all the features are calculated during the same period. The input of neural network includes which day of the week, which half an hour of the day, degree ratio, length ratio, expectation of speed and standard deviation of speed, so the number of neurons in input layer of neural network model is designed for six.

3.2 Hidden layer

$$H(i) = \begin{bmatrix} h_1(i) \\ \dots \\ h_n(i) \end{bmatrix} = \begin{bmatrix} \varphi\left(\sum_{j=1}^n \omega_{j,1} x_j(i) + b_1\right) \\ \dots \\ \varphi\left(\sum_{j=1}^n \omega_{j,n} x_j(i) + b_n\right) \end{bmatrix} \quad (8)$$

where $h_n(i)$ denotes the value of the n th hidden neuron, $\omega_{j,n}$ denotes the weight connecting the j th input neuron and the n th hidden neuron, b_n denotes a bias with a fixed value for the n th hidden neuron, φ denotes a transfer function.

3.3 Output layer

$$y(i) = \varphi\left(\sum_{k=1}^n \omega_k h_k(i) + b\right) \quad (9)$$

where $y(i)$ denotes estimated travel time ratio of link, ω_k denotes the

weight connecting the k th hidden neuron and the output neuron; b is the bias for the output.

4. MODEL APPLICATION

4.1 Study urban road network

We chose partial road network in Wuhan city as a study area, as shown in

Figure 2. The road network is bounded by Wuluo Road, Luoshi South Road, Xionghu Avenue, Dingziqiao Road, including many branches and paths. Obviously, road network in the intersection was interrupted and the degree of each link can be easily obtained from the network except for border link.

4.2 Data preparation

As shown in

Figure 2, we defined a segment between every two intersection of road network as a link. Based on travel time calculation algorithm of single probe vehicle traveling link (Yu et al., 2010), we obtained link travel time of probe vehicle traversing the study area road network during in June and July, 2014. The obtained statistical data includes link ID, entering endpoint ID, exiting endpoint ID, taxi ID, the moment of taxi entering into link, the travel time of taxi traversing link and the average speed of taxi traversing link, as depicted in Table 2.

We obtained historical big data reflecting the traffic characteristics of link. Therefore, we can infer link travel time using these big data under the condition of lacking abundant real-time data. We assume link 82 as the sparse data link. Therefore, link 82 and adjacent links including link 76, link 77, link 81 and link 88, can be viewed as research object. Statistical historical data needs to be preprocessed in order to remove noisy data and we filtered historical data on workdays (from Monday to Friday, except holidays) as experiment data. Consequently, we calculated speed expectation and standard deviation of the adjacent links every thirty minutes during the same period from preprocessed historical data according to week's cycle and traffic flow direction as depicted in Figure 3. Finally, we extracted a total of 1039 features as input of the neural network according to Algorithm 1.

Table 2. Travel information of single taxi

Link ID	Enter endpoint ID	Exit endpoint ID	Taxi ID	Time instance	Travel time (s)	Average speed (m/s)
82	35	48	23501	2014-06-03	100.0	4.89
82	35	48	22608	2014-06-02	85.0	5.75
82	48	35	29444	2014-06-02	101.0	4.84

4.3 Neural network training

A training process is necessary before the ANN model can be applied to estimate link travel times. Three procedures including training, validation and testing were conducted in the whole training process. As depicted in Table 3, we divided the whole dataset into three subset, training dataset, validation dataset and testing dataset. Different quantity of data was used for training, validation and testing. The amount of validation remains the same, namely 10% of total data, the training data was 89%, 85%, 80% and 70%, respectively. And the corresponding testing data was 1%, 5%, 10% and 20%. Training dataset is used in neural network for training. Validation dataset was used to stop training early if the network performance on the validation dataset fails to improve or remains the same. Most of all, it could be used to prevent neural network from appearing over-fitting phenomenon and from reducing the generalization ability of network. Testing dataset is used to test the performance of trained neural network and it was used as a further check whether the network is generalizing well, but do not have any effect on training.

Levenberg-Marquardt algorithm was chosen for neural network training and could provide fast convergence even for large networks. The learning rate was set to 0.01 in order to maintain the stability of neural network. The gradient was set to 1e-5 and the number of validation checks was set to 10. After training and validation, the trained ANN model was applied to estimate link travel time in different amount of data.

Table 3. Training, evaluation and testing dataset

Total data	Training (percentage)	Validation (percentage)	Testing (percentage)	RMSE	MAPE
1039	925(89%)	104(10%)	10(1%)	47.82s	14.61%
1039	883(85%)	104(10%)	52(5%)	62.30s	19.33%
1039	831(80%)	104(10%)	104(10%)	49.16s	23.68%
1039	727(70%)	104(10%)	208(20%)	64.48s	23.28%

4.4 Model evaluation

To evaluate the performance of neural network model designed by us, two performance indicators are used to quantitatively measure the result of the experiment, the Root Mean Square Error (RMSE) and Mean Absolute Percentage Error (MAPE) respectively:

$$RMSE = \sqrt{\frac{1}{n} \sum_{i=1}^n (t_{pv,i} - t_{true,i})^2} \tag{10}$$

$$MAPE = 100\% * \frac{1}{n} \sum_{i=1}^n \left| \frac{t_{pv,i} - t_{true,i}}{t_{true,i}} \right| \tag{11}$$

where $t_{pv,i}$ denotes the estimated travel time of probe vehicle traveling target link; $t_{true,i}$ is true link travel time.

4.5 Results of ANN based on real GPS data

As depicted in Figure 7, it shows the correlation between true link travel time and estimated link travel time in the condition of different amount of data. To estimate travel time, we used the same neural network structure. The linear correlation coefficient R value indicates the correlation between real travel time and estimated travel time and as we can see from Figure 7, with the increase of amount of data, R value has a downward trend. Table 3 lists the performance indicators of ANN, root mean square error (RMSE) and mean absolute percentage error (MAPE). As shown in Figure 7(a), it reaches the best prediction effect when the data is 1% of the amount of data. The mean absolute percentage error is 14.61% and the root mean square error is 47.82 s.

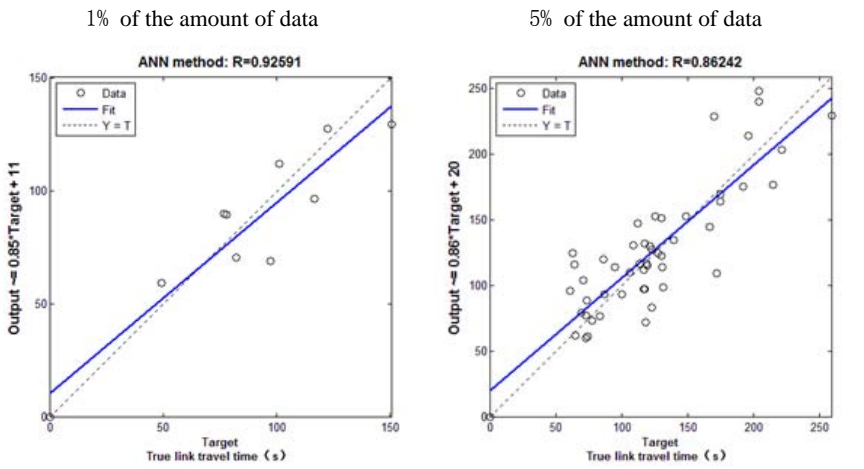

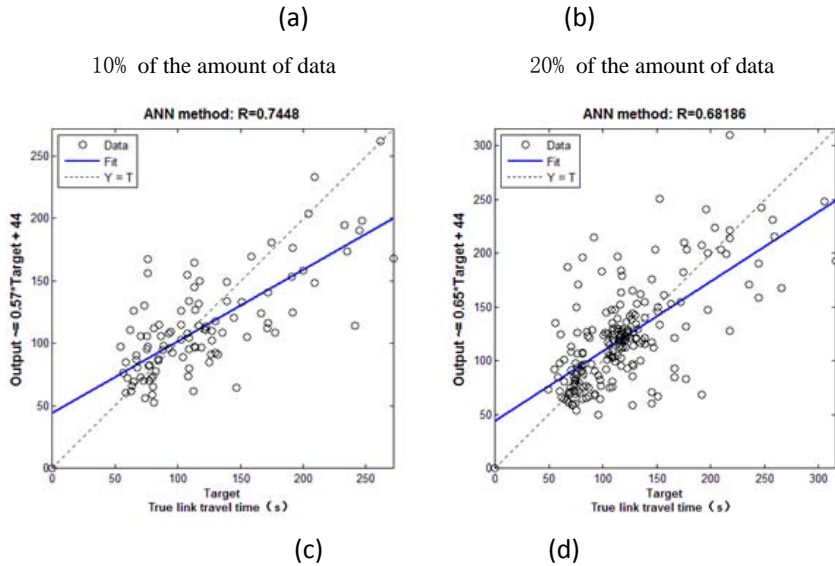

Figure 7. Correlation of link 82 between true link travel time and estimated link travel time

5. CONCLUSION

The running state of probe vehicle to some extent reflects the state of road traffic and link travel time estimation based on data collected by probe vehicles which is one important application of PVD. However, we haven't found related research to estimate link travel time using features relationship between target link and adjacent link. This study firstly estimated target link travel time based on the characteristics between target link and adjacent link. Firstly, we obtained travel time information between link and adjacent link according historic PVDs. Then we extracted features from big data. Finally, we designed a three-layer neural network model for training according to the relationship between target link and adjacent link and predicted target link travel time using trained ANN. Experiments show that in the condition of spare data, we can estimate target link travel time and get better effect.

The proposed ANN model in the paper deals with travel time estimation of target link in view of the sparse data. In future, it is recommended to validate this model using links of other areas and based on a larger real data set. In addition, it is also recommended to apply this model to estimate the route travel time based on prove vehicle data.

6. ACKNOWLEDGE

This research in this paper was supported by national 863 project (2013AA122301) for which the authors are grateful.

REFERENCES

- Oh, J.S., Jayakrishnan, R., Recker, W., (2003). Section travel time estimation from point detection data. In: 82nd Annual Meeting of Transportation Research Board, Washington, DC, USA.
- Liu, H., Van Lint, H., Van Zuylen, H.J., (2007). Neural-network-based traffic flow model for urban arterial travel time prediction. In: TRB 86th Annual Meeting, Washington, DC.
- Kwon, J., Petty K., (2005). A travel time prediction algorithm scalable to freeway networks with many nodes with arbitrary travel routes. In: TRB 84th Annual Meeting, Washington, DC.
- Liu, H., Van Zuylen, H.J., Van Lint, J.W.C., Salomons, M., (2006). Urban arterial travel time prediction with state-space neural networks and Kalman filters. *Transportation Research Record: Journal of the Transportation Research Board*, 1968(1): 99–108.
- Van Lint, J.W.C., Van Der Zijpp, J., (2003). Improving a travel time estimation algorithm by using dual loop detectors. *Transportation Research Record: Journal of the Transportation Research Board*, 1855(1): 41–48.
- Liu, H., (2009). A virtual vehicle probe model for time-dependent travel time estimation on signalized arterials. *Transportation Research Part C: Emerging Technologies*, 17(1): 11–26.
- Hellinga, B., Izadpanah, P., Takada, H., Fu, L.P., (2008). Decomposing travel times measured by probe-based traffic monitoring systems to individual road segments. *Transportation Research Part C: Emerging Technologies*, 16(6): 768–782.
- Wang Y, Zheng Y, Xue Y. (2014). Travel time estimation of a path using sparse trajectories//*Proceedings of the 20th ACM SIGKDD international conference on Knowledge discovery and data mining*. ACM, 25-34.
- Li Y, McDonald M. (2002). Link travel time estimation using single GPS equipped probe vehicle//*Intelligent Transportation Systems, 2002. Proceedings. The IEEE 5th International Conference on*. IEEE, 932-937.
- Herring R, Hofleitner A, Abbeel P, et al. (2010). Estimating arterial traffic conditions using sparse probe data//*Intelligent Transportation Systems (ITSC), 2010 13th International IEEE Conference on*. IEEE, 929-936.
- Hellinga B, Izadpanah P, Takada H, et al. (2008). Decomposing travel times measured by probe-based traffic monitoring systems to individual road segments. *Transportation Research Part C: Emerging Technologies*, 16(6): 768-782.
- Li J (2012). estimation and prediction of link travel time for urban trunk and secondary street. Jilin university.
- YAO En-jian, Zuo Ting. real-time map matching algorithm based on low-sampling-rate probe vehicle data[J]. *Journal of Beijing University of Technology*, 2013, 6: 019.
- Chen Wen (2011). *Ontology-based Modeling, Annotation, Storage, and Query of Semantic Trajectories for Travel Analysis*. East China normal university.
- Zhang Yunfei, Yang Bisheng, Luan Xuechen (2012). Automated matching urban road networks using probabilistic relaxation. *Acta Geodaetica et Cartographica Sinica*, 41(6):933-939

- Li Qingquan, Hu Bo, Yue Yang (2013). flowing car data map-matching based on constrained shortest path algorithm. *Geomatics and Information Science of Wuhan University*, 2013,7:012.
- Dong Hongzhao, Wu Fangguo (2011). Estimation of Average Link Travel Time Using Fuzzy C-Mean. *BULLETIN OF SCIENCE AND TECHNOLOGY*, 27(3): 426-430.
- Jiang Guiyan, Chang Ande, Zhang Wei (2009). "Comparison of link travel-time estimation methods based on GPS equipped floating car. *Journal of Jilin University (Engineering and Technology Edition)*, 39(2): 182-186.
- Zheng Y, Liu Y, Yuan J, et al. (2011). "Urban computing with taxicabs", *Proceedings of the 13th international conference on Ubiquitous computing. ACM*, 89-98.
- Zheng Y, Liu F, Hsieh H P. (2013). "U-Air: When urban air quality inference meets big data", *Proceedings of the 19th ACM SIGKDD international conference on Knowledge discovery and data mining, ACM*, 1436-1444.
- Jula H, Dessouky M, Ioannou P A. (2008). "Real-time estimation of travel times along the arcs and arrival times at the nodes of dynamic stochastic networks", *Intelligent Transportation Systems, IEEE Transactions on*, 9(1): 97-110.
- Zheng F, Van Zuylen H. (2013). "Urban link travel time estimation based on sparse probe vehicle data", *Transportation Research Part C: Emerging Technologies*, 31: 145-157.
- Zhan X, Hasan S, Ukkusuri S V, et al. (2013). "Urban link travel time estimation using large-scale taxi data with partial information", *Transportation Research Part C: Emerging Technologies*, 33: 37-49.
- Chen B Y, Yuan H, Li Q, et al. (2014). "Map-matching algorithm for large-scale low-frequency floating car data", *International Journal of Geographical Information Science*, 28(1): 22-38.
- Yuan J, Zheng Y, Zhang C, et al. (2010). "An interactive-voting based map matching algorithm", *Proceedings of the 2010 Eleventh International Conference on Mobile Data Management. IEEE Computer Society*, 43-52.
- Yu D X, Gao X Y, Yang Z S. (2010). "Individual vehicle travel-time estimation based on GPS data and analysis of vehicle running characteristics", *Journal of Jilin University(Engineering and Technology Edition)*, 40(4): 965-970.
- Liu X, Gong L, Gong Y, et al. (2013). "Revealing daily travel patterns and city structure with taxi trip data", *arXiv preprint arXiv:1310.6592*.
- Fei X, Lu C C, Liu K. (2011). "A bayesian dynamic linear model approach for real-time short-term freeway travel time prediction", *Transportation Research Part C: Emerging Technologies*, 19(6):1306-1318.

NO.16

Inundation Model on Urban Road Intersection Based on The Longitudinal Slope

Laksni Sedyowati^{1*}, Suhardjono², Ery Suhartanto², and Donny Harisuseno²

1 Civil Engineering Department, University of Merdeka Malang

2 Department of Water Resources Engineering, University of Brawijaya

** Corresponding Author, Email: laksnisedyowati@gmail.com*

Key words: Road intersection, longitudinal slope, backwater

Abstract: The rapid growth of the city population, as a consequence of urbanization, had impacted on the provision of facilities and infrastructure, i.e. housings, office buildings and shopping malls, roads, schools, and other public facilities. The availability of pervious land in urban area will decrease, as the impacts of city development. This causes the reduction of the soil's ability to absorb the rain water, so that the drainage load and the peak discharge will increase, and the peak time of runoff is getting short. Unfortunately, the increase of the drainage load is not followed by an improvement of the drainage system capacity. On every rainy season, in almost all major cities in Indonesia experienced inundation with an average depth 20-40 cm. Inundation especially occurs on the main road sections and residential streets caused by the backwater effect as a result of the joining of two or more surface flow at a road intersection with different longitudinal slope. It is necessary to analyze the flow profile at a road intersection with a major review on the longitudinal slope factor. The study design consists of field observations and analytical activities, as follows: determination of the independent variables (i.e. rainfall intensity, longitudinal slope of roads) and the dependent variable (i.e. inundation depth); field measurements and data collection; simulation of flow profiles with various return period of rainfall using Hydraulic Model HEC-RAS; verification of the simulation result of flow profiles using observation data. This research results the relationship between the ratio of the longitudinal slope to the inundation depth at a road intersection and to a non-dimensional number, i.e. Froude Number. The relationship can be well expressed by exponential regression functions, $y = 0.5749e^{0.8965x}$ (x: inundation depth, y: ratio of the longitudinal slope); and $y = 0.8371e^{1.7523x}$ (x: Froude Number, y: ratio of the longitudinal slope). The ratio of the longitudinal slope is the comparison between the slopes of the roads that intersecting. The result also show that the optimum slope ratio is 0.75 where the inundation depth is still going on an allowable limit, and the rain with a return period of 2-year had already resulted an inundation depth exceeding the allowable limit.

1. INTRODUCTION

1.1 Background

The rapid growth of the city population, as a consequence of urbanization, had impacted on the provision of facilities and infrastructure, i.e. housings, office buildings and shopping malls, roads, schools, and other public facilities. The availability of pervious land in urban area will decrease, as the impacts of city development. This causes the reduction of the soil's ability to absorb the rain water, so that the drainage load and the peak discharge will increase, and the peak time of runoff is getting short. Unfortunately, the increase of the drainage load is not followed by an improvement of the drainage system capacity. In every rainy season, in almost all major cities in Indonesia experienced inundation with an average depth 20-40 cm. This condition interferes with the activity of society and cause discomfort, especially for road users.

From the preliminary study conducted on some major roads in the city of Malang East Java, inundation usually occurs on roads with lower elevation and the road at the intersection. At every intersection, inundation does not always occur, but from some initial observations that have been made, at the junction with the differences of longitudinal slope are quite large, always occur the inundation higher. The condition is thought as a backwater effect that resulted from the joining of two or more of surface flow at the road intersection.

During heavy rains, road can serve as a floodways (Sutherland, 1996). Floodways are sections of roads which have been designed to be overtopped by floodwater during relatively low average recurrence interval (ARI) floods (Anonymous, 2010a). A roadway across a shallow depression subject to flooding, specifically designed to overtop and constructed to resist the damaging effects of overtopping (Smith, 2006). The type of road pavement (Yi, 2005), the road network (Lee, 2014), spatial development change (Harisuseno, 2012), and road rain pump (Huang, 2014) influence the inundation depth and the reduction of the runoff quantity. To assess where on the road most water from the surroundings will assemble, and how water will flow over the road after heavy rainfall by the use of a Laser Mobile Mapping System (LMMS) which, at high measuring rate, captures dense and accurate point clouds (Wang, 2014). Maximum ponding depth on the road does not depend significantly on longitudinal grade, but the location of maximum ponding depth is very sensitive to longitudinal grade (Charbeneau, 2008). There was no study that investigated the inundation model at a road intersection. It is therefore hoped that the current research would find out the inundation model in urban road intersection based on the longitudinal slope as a part of stormwater management. This model could

be used to estimate the road inundation and runoff based on the slope data.

1.2 Problem Statement

The urban drainage system in Malang and its surroundings areas is overwhelmed with a number of problems. In spite of the fact that Malang is a plateau region, in every rainy season on some areas especially the road intersections are always flooded between 40-60 cm that exceeds the maximum permitted is 30 cm (Sutherland, 1996). This condition is thought as the impact of backwater flow. Problems to be studied in this research are as follows:

1. How is the inundation profile on the road intersection?
2. How is the relation between the ratio of longitudinal slope with the runoff discharge and the inundation depth?
3. How is the relation between the ratio of longitudinal slope and the non-dimensional Froude Number?

1.3 Objectives

The main objective of this study is to determine the flow profile at a road intersection with a major review on the longitudinal slope factor. To achieve the main objective, this study also was designed with several specific objectives as follows:

1. To know the inundation profile on the road intersection.
2. To know the relation between the ratio of longitudinal slope with the runoff discharge and the inundation depth.
3. To know the relation between the ratio of longitudinal slope and the non-dimensional Froude Number.

2. LITERATURE REVIEW

For streets in residential areas which are designed to function as integral components of the major drainage system when pipe capacities are exceeded, velocity and depth limits shall be dictated by safety of children first and stability of cars second. Car stability is significant because of the potential for increased flood levels due to floodway blockage. Where the road longitudinal section is formed as a series of dips and crests (more usual in flat terrain) with a nominal grade applied along the crests, backwater analyses shall be provided to verify conditions with such road formations. Recommended safety limits for road intersections: $V_{av,dav} \leq 0.35 \text{ m}^2/\text{s}$ and $d_{av} \leq 0.30 \text{ m}$ (using the cross-section at kerb return on the downstream

side of the intersection on the floodway route), subject also to $d_{max} < 0.30$ m measured at the centreline road crown intersection point. Floodway hydraulics may be determined using Manning's Equation. Unless uniform flow conditions can be confidently predicted, steady-state backwater programs such as HEC-RAS shall be used to compute depths and velocities (Sutherland, 1996).

Simulating stormwater runoff at superelevation transitions by the use of a diffusion wave numerical model had found out that maximum ponding depth does not depend significantly on longitudinal grade, but the location of maximum ponding depth is very sensitive to longitudinal grade, moving from the outside pavement edge for small longitudinal slope, to the center of the roadway for moderate slope, and to the inside pavement edge for large longitudinal grade (Charbeneau, 2008). A Laser Mobile Mapping System (LMMS) enables the identification of sinks on the roadside, i.e. the locations where water flow accumulates and potentially enters the road. Moreover, the method divides the road's direct neighbourhood into catchments, each consisting of all grid cells having runoff to the same sink. In addition the method is used to analyse the surface flow over the road's surface. The new method is demonstrated on a piece of 153 meters long Galician mountain road as sampled (Wang, 2014). Simulating homogeneous and non-homogeneous network types to estimate the effect of road networks and building groups by the use of two-dimensional run-off flow model and one-dimensional slot-model simulated ground surface run-off flow and sewer pipe flow resulted that a non-homogeneous case could calculate more reasonable results (Lee, 2014). Estimating spatially distribution of runoff depth in order to to promote the spatial planning development by the use of hydrology model KINEROS based Geographical Information System (GIS) resulted that runoff depth distribution map in the study area greatly influenced by rainfall intensity and landuse type. The increasing of runoff depth directly will cause flood and inundation (Harisuseno, 2012).

3. MATERIAL AND METHOD

3.1 Study Area

Study area is located at Bhumi Purwantoro Agung, Malang City, along Sulfat Highway. The total number of observation points or road intersection is ten points, located in Taman Sulfat Housing which is the outlet of runoff in the study area. The ten road intersections are defined as TS1, TS3, TS5, TS7, TS9, TS11, TS13, TS15, TS17, TS19.

The major land covering at the study area are building houses, roads are

equipped with drainage channels, but there are several roads without drainage, as well as a small part in the form of an open space area.

Formerly, the housing in the study area was farmland. Along with the development of the city, then the area converted into residential areas with medium density.

3.2 Methodology

The research method is analytic observational study, consist of observation and data collection in the field, as well as the analysis of flow profiles using a hydraulic model. The modelling results will be verified by using the results of field observations on certain conditions in accordance with rain events.

This research was conducted by using flow in open channels approach with a wide cross-section. Geometrical data of road that includes a cross-sectional and longitudinal slope obtained through direct measurements in the field. Whereas the flow profile caused by the backwater phenomenon that includes the data of flow velocity and flow height obtained using HEC-RAS hydraulic model version 4.0. Verification is done by using the data model of water level observations at several rain events. Road intersection observed is the intersection of a meeting between a residential street to the main road in Bhumi Purwanto Malang Housing which is an outlet of surface runoff.

3.2.1 Data Collection

Primary data. The primary data consist of topographic maps, road geometry and inundation depth. Topographic map scale 1: 10,000 of the study area was not available so that need to be made by direct measurement. Measurements for mapping using theodolite. The data of road geometry include cross and longitudinal section. Cross-section measurements performed on each interval of 20 m. Measurement of cross and longitudinal profile was performed using waterpass. Water level data was obtained by direct measurements at points of observation that were experiencing inundation during the rainy season in the study period.

Secondary data. The secondary data is daily rainfall data from three rainfall stations, namely Abdul Rahman Saleh Station, Ciliwung Station and UB Station. Rainfall intensity data is determined from the maximum daily rainfall data analyses.

3.2.2 Calculation of Runoff Discharge

Runoff discharge is calculated by using the Rational Method. The maximum daily rainfall at various return period is calculated following the Log Pearson III distribution. After that the discharge drainage system is determined based on the scheme of drainage system in the study area.

3.2.3 Simulation of Inundation Profile

Simulation of inundation profiles using hydraulic model HEC-RAS version 4.1 was conducted in order to determine the flow profile at the point of observation on the various return period rainfall and the various longitudinal slope of road intersection in the study area. This step is also used to find out the length of backwater curve from the intersection to the upstream, so that it can be seen spreading inundation that occur at various return period rainfall and various longitudinal slope.

This activity consists of several stages. First, the geometric data preparation and flow rate at various return period rainfall; data input; and running the program to achieve the defined boundary conditions. The second is the processing of hydraulic model test data to obtain inundation depth occurred at the road intersection in a various of return period rainfall. Thirdly, determination of the calibration factor using field measurement data and water level observations. This activity is intended to ensure that the data used can be running with HEC-RAS software, and in case of deviations can be adjusted using the calibration factor. The lastly is viewing the results. Several output features are available under the view option from the main window. These options include: cross section plots; profile plots; rating curve plots; X-Y-Z perspective plots; tabular output at specific locations (Cross Section Table); tabular output for many locations (Profile Table); and the summary of errors, warnings, and notes.

Boundary conditions are required in order to perform the calculations. If a subcritical flow analysis is going to be performed, then only the downstream boundary conditions are required. If a supercritical flow analysis is going to be performed, then only the upstream boundary conditions are required. If a mixed flow regime calculation would be performed, then both upstream and downstream boundary conditions are required (Anonymous, 2010b).

3.2.4 Verification of Simulation Result

Verification is conducted to ensure that the model is representative of the entire existing parameters corresponding to the basic theory. in this

research, verification is done by using the data model of water level observations at several rain events. Road intersection observed is the intersection of a residential street and the main road in Taman Sulfat Housing, Malang City, which is an outlet of surface runoff.

4. RESULTS AND DISCUSSION

4.1 Hydrological Data

Hydrological data collected in the form of daily rainfall data from three rainfall stations, namely Abdul Rahman Saleh station, Ciliwung Station and Station UB, with a data length of 10 years from 1998 to 2007, which is taken from the Bureau of Meteorology and Geophysics Malang. Furthermore, the testing data outliers and inlier. Determining the frequency distribution of rainfall data used two distribution, namely Gumbel and Log Pearson Type III. Both methods have been widely used in the calculation of Hydrology Analysis and has given satisfactory results. To determine one distribution that will be used in subsequent analyzes determined by test frequency distribution with the Kolmogorov-Smirnov method and Chi-Square. The results showed that both the frequency distribution model is accepted, but only one would be used in the next analysis that is the frequency distribution of Log Pearson Type III, because it has a smaller D_{maks} value.

4.2 Design Rainfall

Design rainfall is calculated based on the maximum daily rainfall data from rainfall stations. The average rainfall is determined by using Polygon Thiessen. Analysis of the frequency distribution using Log Pearson III method is performed to determine the design rainfall in various return period rainfall. The results is shown in Table 1 as follow.

Table 4. Maximum Design Rainfall using Log Pearson III Method

T (year)	k	Log XT (mm)	XT (mm)	Probability (%)
2	0.022	2.000	100.004	50.00
5	0.841	2.071	117.683	20.00
10	1.266	2.107	128.077	10.00
25	1.735	2.148	140.586	4.00
50	1.982	2.169	147.680	2.00
100	2.228	2.191	155.080	1.00

200	2.451	2.210	162.129	0.50
1000	3.577	2.307	202.838	0.10

4.3 Discharge of Road System

Based on the condition of the road network in the study area, then the road system is made as shown in Figure 1 below. Firstly, calculation of the amount of discharge runoff that flows in each catchment. The catchment boundaries were defined as the streets in the scheme. Runoff discharge and discharge of road system were calculated at various return period that is 2, 5, 10, and 25 year. Calculation of runoff discharge can be seen in Table 2 below.

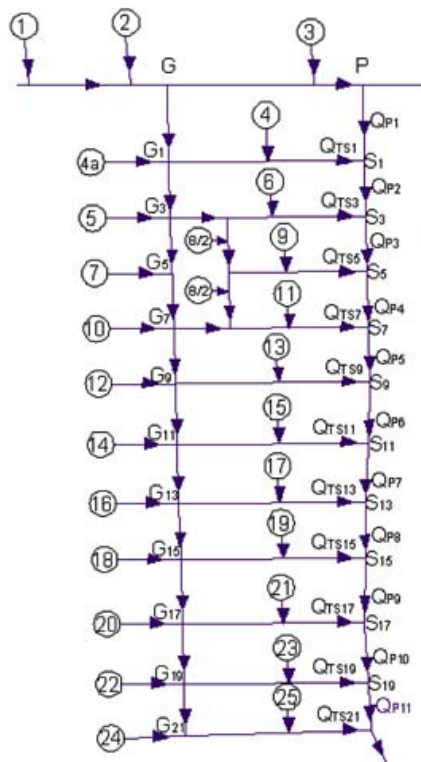

Figure 8. Road system at the study area

Discharge of road system is determined by adding the discharge runoff captured by each road, correspond to the lane of road network.

Table 2. Maximum Design Rainfall using Log Pearson III Method

Intersection Point	Road Segment	Discharge of Road System (m ³ /s), in Return Period (T)							
		year							
		2	5	10	25	50	100	200	1000
S1	P1	2.69	3.17	3.44	3.78	3.97	4.17	4.36	5.46
	TS1	0.69	0.81	0.88	0.97	1.02	1.07	1.12	1.40
S3	P2	3.38	3.97	4.33	4.75	4.99	5.24	5.48	6.85
	TS3	0.43	0.51	0.55	0.61	0.64	0.67	0.70	0.88
S5	P3	3.81	4.48	4.88	5.36	5.63	5.91	6.18	7.73
	TS5	0.17	0.20	0.22	0.24	0.25	0.27	0.28	0.35
S7	P4	3.98	4.69	5.10	5.60	5.88	6.18	6.46	8.08
	TS7	0.16	0.18	0.20	0.22	0.23	0.24	0.25	0.32
S9	P5	4.14	4.87	5.30	5.82	6.11	6.42	6.71	8.40
	TS9	0.39	0.46	0.50	0.55	0.58	0.61	0.64	0.80
S11	P6	4.53	5.33	5.81	6.37	6.69	7.03	7.35	9.19
	TS11	0.35	0.41	0.45	0.49	0.52	0.54	0.57	0.71
S13	P7	4.88	5.75	6.25	6.86	7.21	7.57	7.92	9.90
	TS13	0.24	0.28	0.30	0.33	0.35	0.37	0.38	0.48
S15	P8	5.12	6.03	6.56	7.20	7.56	7.94	8.30	10.39
	TS15	0.23	0.28	0.30	0.33	0.35	0.36	0.38	0.48
S17	P9	5.36	6.30	6.86	7.53	7.91	8.30	8.68	10.86
	TS17	0.26	0.31	0.34	0.37	0.39	0.41	0.43	0.53
S19	P10	5.62	6.61	7.20	7.90	8.30	8.71	9.11	11.40
	TS19	0.28	0.32	0.35	0.39	0.41	0.43	0.45	0.56
	P11	5.89	6.94	7.55	8.29	8.70	9.14	9.56	11.96

4.4 Simulation Results

Figure shown below is the cross section plot of the road intersection at the downstream of the road network, and the long section plots of the inundation profile on the main road.

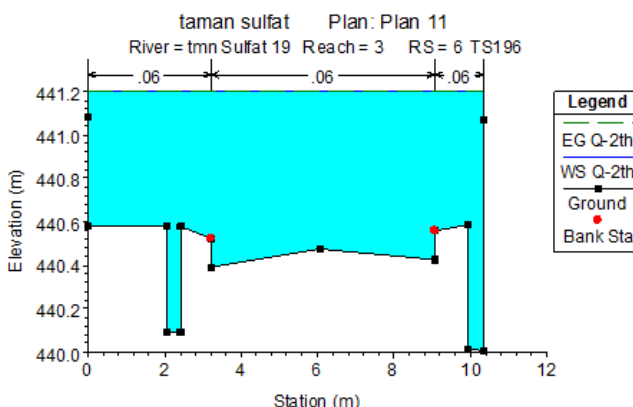

Figure 2. Cross section plot of the road intersection at the downstream

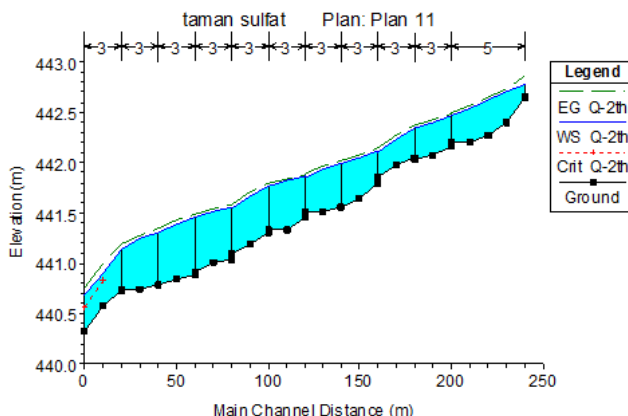

Figure 3. Long section plot at the main road

Figure 2 shows that at the intersection of Tmn Sulfat 19 occurs inundation at an elevation of 441.2 meters. The center of the road is at elevation 440.5, so that the depth of a inundation is 0.7 meters. Figure 3 shows that the flow profile that occurs at the main road is the backwater curve except at the downstream end of the flow profile changes gradually become drawdown curve. As mentioned above, a long the main road, there are ten intersections.

4.5 Ratio of Longitudinal Slope

Longitudinal slope is calculated from the difference elevation between two points at road center at a distance of 10 m. The elevation is measured by using waterpass. The ratio of the longitudinal slope is determined by comparing the slope of roads branch with the slope of the main road. At each point of intersection will be obtained one ratio of the longitudinal gradient

4.6 Field Observation Result

Field observation results consist of inundation depth measurement data, and the picture of the backwater phenomenon in initial and stormwater runoff condition.



Figure 4. Backwater flow in initial condition



Figure 5. Backwater flow in stormwater runoff condition

4.7 Verification of Simulation Result

Verification result is shown in Table 3 below.

Table 3. Calculation of the differences between inundation depth observation and simulation

Date	Rainfall Depth (mm)		Inundation Depth (mm)								Accuracy (%)
			S13		S15		S17		S19		
	Obs	Calc	Obs	Sim	Obs	Sim	Obs	Sim	Obs	Sim	
13-03-14	118	100	270	320	370	430	350	400	250	300	82.74
30-02-14	95	100	250	320	350	430	330	400	230	300	74.37
26-12-13	80	100	230	320	320	430	320	400	210	300	64.66

The table above shows that the simulation results provide inundation depth data is relatively higher than the data of observation. The accuracy of those data between the range of 64.66% - 82.74% or the average is 73.93%. It can be concluded that the simulation model gives results closer to the observations.

4.8 Hydraulic Characteristics of Flow at the Road Intersection

To determine the effect between the variables at the road intersection is done by using regression equation and scatter diagrams method. Selection of formulas or scatter diagram models based on the largest coefficient of determination R^2 among some alternative models and empirical models of the flow phenomena that already known, namely exponential or polynomial or logarithmic model. From the result of hydrological analysis and simulation of flow profile, it could be seen that the rainfall with a return period of two years has caused inundation of water level exceeds the allowable. The result also shows that at several road intersections especially at the downstream part in the study area occur backwater phenomena, which indicated by a rise in water level at the downstream end of the road, and the lower flow velocity in the area around the intersection. Figure 6 below shows the relation between the flow velocity and the inundation depth. The relation can be well expressed by exponential regression functions, $y = 0.7997e^{-2.7219x}$ (x: flow velocity; y: inundation depth).

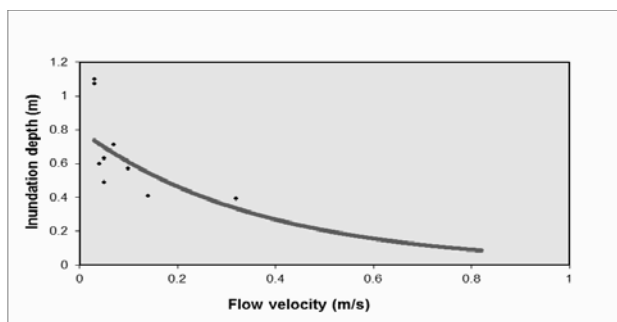

Figure 6. Relation between the inundation depth and flow velocity

4.9 Relation between Inundation Depth and Ratio of Longitudinal Slope

From Figure 7 below shows that the intersection between the discharge curve and the ratio curve occur in inundation depth of 0.2 meters. This depth is smaller than the maximum water level condition that is allowed on the road. Therefore it can be concluded that the optimum ratio of longitudinal slope in the study area is 0.75. It also shows that the ratio of the longitudinal slope has a relationship and a positive influence, not too tightly, against the water level, which is expressed by exponential regression functions, $y = 0.5749e^{0.8965x}$ (x: inundation depth; y: ratio of the longitudinal slope), with determination coefficient of 14.15% and 1.32 F test results;

while the runoff discharge has a negative effect relationship and fairly close to the water level, which is expressed by exponential regression functions, $y = e^{-1.702x}$ (x: inundation depth; y: runoff discharge), with determination coefficient of 37.12% and amounted to 4.72 F test results.

Figure 7. Relation between the inundation depth with the ratio of longitudinal slope and runoff discharge

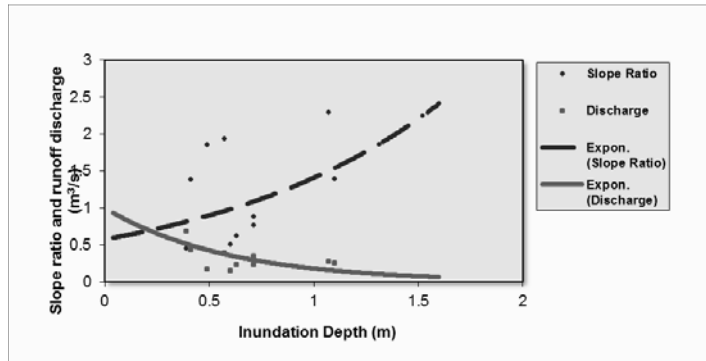

4.10 Relation Between The Ratio of the Longitudinal Slope and the Inundation Depth with A Non-Dimensional Froude Number

Analysis of the relation between the ratio of the longitudinal slope and a non-dimensional number, in this case a Froude Number, intended for charts or formulas generated from this study related to the main variable, that is ratio of the longitudinal slope could be used at other road intersection outside the study area without the need to pay attention to the road geometric data and the amount of runoff discharge.

By knowing the ratio of Froude Number of two flow at a road intersection, it could be known the magnitude of slope ratio. Furthermore, by using the graph in Figure 7 above could be determined the water level that occurred on the road intersection.

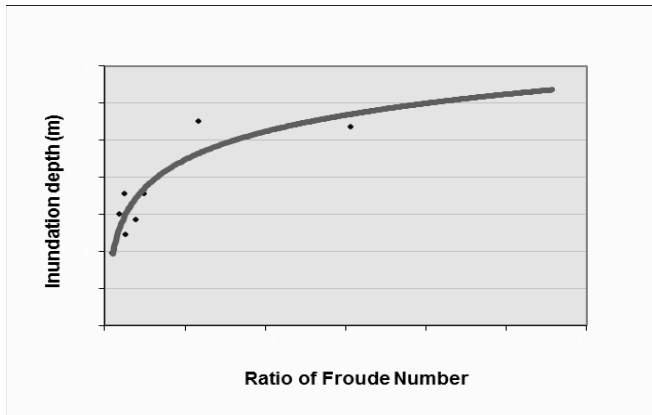

Figure 8. Relation between the ratio of Froude Number and the inundation depth

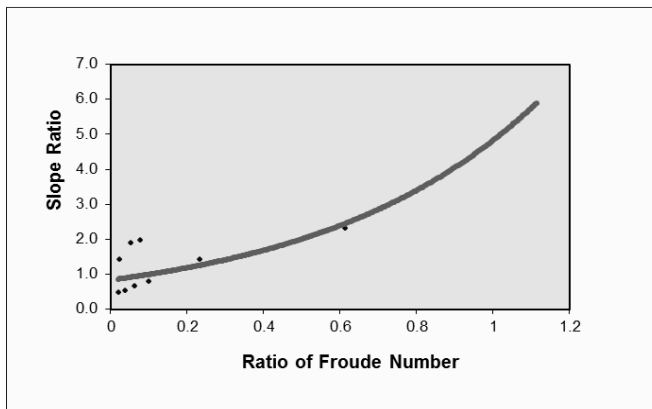

Figure 9. Relation between the ratio of Froude Number and the ratio of longitudinal slope

From Figure 8 above, it can be seen that the ratio of Froude Number has a positive relation and fairly close to the non-dimensional Froude Number which is expressed by logarithmic regression functions $y = 0.2194\ln(x) + 1.2472$, (x:ratio of Froude Number; y:inundation depth), with determination coefficient of 85.09% and F-test result of 5.54.

From Figure 9 above, it can be seen that the ratio of the Froude Number has a positive relation and fairly close to the non-dimensional Froude Number which is expressed by exponential regression functions, $y = 0.8371e^{1.7523x}$ (x:ratio of Froude Number; y:the ratio of the longitudinal slope), with determination coefficient of 29.46% and F-test result of 3.34.

5. CONCLUSIONS AND RECOMMENDATIONS

Rainfall with a return period of two years has resulted in a inundation depth in the study area exceeding the allowable. At several of the road intersections occur backwater flow. It is characterized by the rise in water level at the downstream end of all roads at Taman Sulfat Housing (TS1, TS3, TS5, TS7, TS9, TS11, TS13, TS15, TS17, TS19) which is the meeting point with the main road. It is also characterized by a lower flow velocity in the area around the meeting point (the downstream end sections of Taman Sulfat Road). The flow velocity has a negative relationship to the inundation depth, which is expressed by exponential regression functions, $y = 0.7997e^{-2.722x}$, with determination coefficient of 47.54%. The ratio of the longitudinal slope has a positive relation to the water level, which is expressed by exponential regression functions, $y = 0.5749e^{0.8965x}$, with determination coefficient of 14.15% and 1.32 F test results; while the runoff discharge has a negative relation and fairly close to the water level, which is expressed by exponential regression functions, $y = e^{-1.702x}$, with determination coefficient of 37.12% and amounted to 4.72 F test results. The ratio of the longitudinal slope has a positive relation and fairly close to the non-dimensional Froude Number which is expressed by exponential regression functions, $y = 0.8371e^{1.7523x}$, with determination coefficient of 29.46% and F-test results at 3:34. The optimum slope ratio at Taman Sulfat Housing in Malang City is 0.75, with a water level that occurred still meet the requirements of permissible water level occurred on residential roads.

The research results can be used as a basis for determining the slope criteria and the capacity of the drainage channel with inundation depth within allowable level. For a more optimal result which gives a clearer overview the relation between the main observation variables, further research needs to be done at the location where the longitudinal slope more varied. It is needed to study more specific road characteristic, i.e. road without and with drainage channels, to minimize the influence of other variables outside the model.

REFERENCES

- Anonymous. 2010a. "Floodway Design", Road Drainage Manual, Department of Transport and Main Roads, Australia.
- Anonymous. 2010b. "River Analysis System HEC-RAS version 4.1", Release Note, US Army Corp of Engineer, Hydrologic Engineering Center.
- Charbeneau. R.J., Jeong, J., et al. 2008. "Highway Drainage at Superelevation Transitions", Technical Report, Center for Transportation Research The University of Texas at Austin, in cooperation with the Texas Department of Transportation and the Federal Highway Administration.

Infrastructure & Transportation Planning

- Harisuseno, D., Bisri, M., et al. 2012. "Runoff Modelling for Simulating Inundation in Urban Area as a Result of Spatial Development Change", *Journal of Applied Environmental and Biological Sciences*.
- Huang, J., Wang, S., et al. 2014. "Numerical Study on the Impact of GongJi Road Rain Pump on the Waterlogging in Huinan, Pudong District", *Journal of Geoscience and Environment Protection*, Published Online December 2014 in SciRes.
- Lee, S., Nakagawa, H., et al. 2014. "Urban Inundation Simulation Considering Road Network and Building Configurations", 6th International Conference on Flood Management, September 2014, Sao Paulo, Brazil.
- Smith, E.R. 2006. "Floodway Design Guide", MRWA Floodway Design Guide, Structures Engineering of Main Roads Western Australia.
- Sutherland, R., Jones, T., et al. (1996). "Floodway Safety Criteria", Model Guidelines Version 2 May 1996, Melbourne Water Technical Working Group.
- Wang, J., Gonz'alez-Jorge, H., et al. 2014. "Geometric Road Runoff Estimation From Laser Mobile Mapping Data", *ISPRS Annals of the Photogrammetry, Remote Sensing and Spatial Information Sciences*, Volume II-5, ISPRS Technical Commission V Symposium, 23 – 25 June 2014, Riva del Garda, Italy.
- Yi, J., Yeo W.G., et al. 2005. "Analyzing Stormwater Runoff Decrease Effects by Using Porous Pavements", XXXI IAHR CONGRESS, September 11-16, 2005, Seoul, Korea pg. 1171-1178.

NO.35

The Research of Elderly People's Social Support and Walking Space by Space-time Path

A Case Study of Taipei Xinyi District

Shu-Ying Tsai^{1*}, Ting-Yueh Chen¹ and Chuan- Jen Ning^{1*}

1 Department of Architecture and urban design, National Taipei University of Technology.

** Corresponding Author, Email:tsaishuying0914@gmail.com ; patrick52310@gmail.com*

Key words: Elderly, Social Support, Walking Environment, Global Positioning System.

Abstract: Under the trend of global aging, the issue of elders should be paid attention. Up to January 2014, the aging population society occupied 11.57% in Taiwan. Approximately, in 2017 Taiwan will step into Aged society. In order to make the senior have a healthy and better life, the living environment and space arrangement will be the important part in urban city. This study statistics the walking space and the living path of elders by outdoor activity type, walking range time and walking environment to understand the activity condition and type of elders in Xin-Yu district and also testified by the guide of "Global Age-friendly Cities Outdoor Spaces and Building" in the guide of the World Health Organization. This study investigates 22 seniors in Xin-Yi district by record of the Global Positioning System, observation and deeply interviews to explore the influence factor like activity type, activity item, space equipment and walking environment of elders to propose the requirement of walking space and the improvement subjects in Xin-Yi district. The result found out that the condition of elder activity and society support, the demand of activity environment and walking space for social type elders are public social space, safe crossing road space, bus stop and support by the information on the bus; the demand of activity environment and walking space for selection type elders are communication chairs at shop arcade, diverse sports facility; the demand of activity environment and walking space for essential type elders are participatory to the open space, groups cooperative facility. By the setting and improving of the items above, wish it can improve the social support for elders then we can provide a friendly and healthy urban city activity space for them.

1. INTRODUCTION

As the world's population goes up, aging problems are being noticed. According to the Directorate-General of Budget, Accounting and Statistics

in Taiwan the population in Xin-Yi district is 228,125, and there has 30684 people are more than 65 years old, the proportion of aged population is 13.45%, and it close to the standard of the aging society of the United Nations with 14%.The district of Xin-Yi is the really important part of Taipei. There are many constructions and city planning is representative in Taiwan, so it should be examine the needs of living environment for elderly. This study is discuss about the Elderly People's Social Support and Walking Space in Xin-Yin district, with the type of the outdoor activity, Walking time and pedestrian path environment and other factor to understand the activity condition of the elderly in Xin-yin district, and statistical the maximum number of the activities space as the research centre in the walking space of the neighbourhood. Through the establishment of this place, can improve social support for the elderly, and then provide more social support and activities.

2. CONTENT AND METHODS

2.1 Literature Reviews

Elderly pedestrian space: Means walking is most primitive way of moving for human, and has convenience, accessibility, mobility, almost no-cost economy. There are five types of the walking space, such as Flinch arcade, a narrow sidewalk (<2m) + arcade, are wider sidewalks (> 2m) + arcade, sidewalk + retreat space, sidewalk. Walking space-related facilities are including six projects such as en vironmental infrastructure, transportation, services, information, management and maintenance of the landscape.

2.1.1 Time and space path

Golledge & Stimson (1997) call all the space that people may be in direct contact with on the daily basis the “activity space”. Space is an important manifestation of daily life, and daily activity space can be divided into three parts: 1. moving from home and its surrounding. 2. Round-trip between general Activity Location. 3. Moving around with activity space. Using this three activity as the based, activity space can be conceptualized as (a hierarchy of movement). The concept of space-time path expression is to express activity behaviour in space and time. Path can be expressing as the whole individual behaviour. Include mobile path, dwell time, and activities.”

2.1.2 Elderly Social Support

According to Kristina (1992), the research is analysis the theory of aging and the relationship of social support with the elders. That the elderly person with the age, social interaction will be reducing. However, the research found out it's won't be affect by the time pass, and there is no difference in age of social support ; there are five influential social support for elderly health status such as Instrumental support, emotional support, information support, interactive community support, family support, etc. Instrumental support to directly affect the health of the elderly, Increased social support and social networks can reduce the risk of depression, but also to raise the quality of life, enhance the independence of daily live.

1. Emotional support: The expression of positive and considerate.
2. Information support: Message of advice, guidance or evaluation support.
3. Instrumental support: providing material assistance or psychological support.
4. Social support interaction: the familiar social integration or home.
5. close support: the expression of love and affection.

The research proved instrumental support and intimacy have significant impact on other social support, social support interaction: Mental, physical health, physical environment, increase energy, social behaviour the most. Therefore, through the daily path can observe the activity and behaviour of the elderly person and events.

2.2 Research Methods

In this research, observation and study 22 elderly people in Xinyi District, Taipei, and through interview methods and using the GPS cameras record to statistics elderly person go places, walking, activity behaviour. Then found out the social support for elderly people in the activity.

3. RESEARCH ANALYSIS

In this research, study the activity path of 22 elderly people. The observation include: Daily life path, walking time and distance, outings, etc., and the total distance and time, and from the research to analysis the relationship with the length of the walking, activity type and workplace behaviour. Then, recommend the possibility ideas for improvement in the future.

3.1 Activity type for the elderly

There are three types of outdoor activities such as social type, selection type and necessary type.

3.1.1 Social type

Define the Range of activities and activity participation in other area and in the Xinyi District.

3.1.2 Selection type

the range of activities is in Xinyi District, Day activities are more than 2 types, and does not stay long at a same location, activities path are more varied.

3.1.3 Necessary type

stay long at same location, at the range of activities is in village, and must activities are necessary to do in the daily life.

As the table 1, most of the type of the Elderly Activities are selection type and there have 11 people in this type. Second is the social type, and have 7 people in this type, last is the necessary type, and have 4 people in this group. Walking time from most to least is: necessary type, social type, and selection type. . Walking distance from most to least is: social type, selection type, and necessary type.

This research records by the GPS found out that the social type of the elder's has the longest walking distance, and will take the transportation. Selection type of the elder's takes least time on walking, and the activities have more change. The necessary type of the elder's has the shortest walking distance, but spends the most time on walking, because their activities are necessary to do in the daily life, so the range is near by the house in 500m. Therefore, the distance is short, and the attitude is in casual, so they spend more time than the others. The necessary type has the purpose of casual on walking, but the social type and selection type has purpose of traffic on walking.

Table 5. walking distance and time

Table1		walking distance and time
types	People	Xinyi District 【walking time (minute)/distance (meter)】
social	7	76/2960 meter
selection	11	65 /2222 meter
necessary	4	86 /1274 meter
average	22	72 /2284 meter



Figure 1. The Respondent walking path for a day

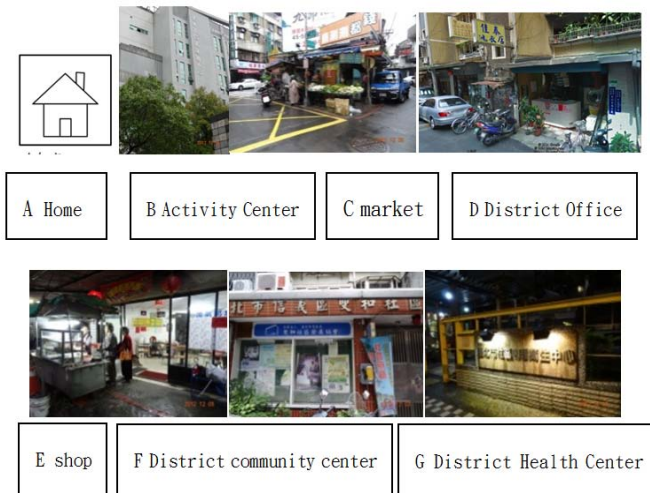

Figure 2. The Respondent walking path for a day

3.2 The needs for the walking space and activity space for the elderly.

The walking purpose for the elderly is divided into two "Traffic" and "leisure". Social type has purpose of traffic on walking. Selection type has purpose of traffic and leisure on walking, and necessary type has the purpose of leisure on walking. The conditions of walking space for the purpose of traffic are: street's looks, street connection, public facilities and property, livelihood facilities, and comfort of pedestrian space, safety; The conditions of walking space for the purpose of leisure are: street's looks, livelihood facilities, comfort of pedestrian space ,open space near nature,

sports facilities for public, and social support. Distance for the Social type of elderly's to walk to the activity space within 12 minutes, and 675 meters, most of the places are community centre, mountain, sports centres, hospitals and clinics, public agencies, large exhibition games and so on. While demand in events and walking paths, including public facilities availability, sociability open seating area, connecting to safe streets. Distance for the selection type of elderly's to walk to the activity space within 10 minutes, and 343 meters; most of the places are squares, parks, shops, churches, mountains and other places, while demand in the activities and walking paths including shops arcade seating areas, sports facilities. Distance for the necessary type of elderly's to walk to the activity space within 6 minutes, and 145meters; most of the places are markets, parks, shops, community plaza, while demand in the activities and walking paths include activities communicative, open space participation.

3.3 Elderly Activities Social Support

The effect of the Elderly activity types not only by personal factors, factors of the types of activities, venues and facilities factors, environmental factors, community factors, but also the social support is also the consideration for the elderly activity, during the activity, elders can get emotional support, information support, instrumental support, interactive support social and intimate support. In addition this research has the religious activities of elders so. Therefore, these researches not only discuss about the emotional support, information support, instrumental support, interactive support social and intimate support, but also have discuss religious support in physiology, psychological perception, social contact, sensory experiences and other analysis.

3.3.1 Social type

Most of the social type elders take bus to participate in various volunteer services, although the service types are difference, but the elders get the social support during the volunteer, including fitness type and service type. Service types of elders, by serving people to promote their positive life in old age, and create their own social groups, this type of elders can get emotional support, instrumental support, messaging support, and social support from the service. Fitness type of elders, most of them are alone during the activity, therefore this type of elders don't get the messaging support, and social support from the service.

3.3.2 Selection type

Most of the selection type elders take bus, motorcycle, and bicycles to the activity places. Their activities motivated by personal interest and which is divided into three categories included: Personal activities category, Sports category, and religious category.

3.3.2.1 Category of personal activities and sports

The activities have lot of kinds for the personal activities type of elders but the intersection between people is less and the time is short as well, therefore these types of elders can get emotional support, instrumental support and information. Sport type of elders, most of them are alone during the activity, and the range is short. Therefore this type of elders can get instrumental support.

3.3.2.2 Religious type

This type of elders the activities are related to religious activities and most of the activities are group activities. Therefore, religious type of elder can get social support, and religious support, which include emotional support, instrumental support, messaging support, social support and religious support.

3.3.3 Necessary type

This type of elders walks to the activity space, for the basic needs of daily life. Most the activities place is the community and the place is include community care centres, markets, community square, neighbourhood parks, and they can get emotional support, instrumental support, messaging support during the activities.

Table2. Social support for the different type of elders

Range of the Activities	Types of the Activities	Emotional Support	Instrumental support	Information support	Interactive community support	Religious Support	Activities place/ Transportation
2050m	Social type	+	+	+	+	-	Community Care

	Service type	+	+	-	-	-	Centre ,Senior Centre, Park, sports centre /bus, walk
700m	Sport type						
	Selection type	+	+	+	-	-	Shops, cafes shops, Activity centre, park, Mountains, plaza ,church, campus / bus, walk, bicycle
	Personal activities	-	-	+	-	-	
	Sport type	+	+	+	+	+	
200m	Religious type	+	+	-	-	-	
	Necessary type						Markets, parks, community care centres, community plaza /walk

3.4 Pedestrian space, social support and aged friendly city checklist

This study combines the, walking space facilities and the social support for the social type, selection type, and necessary type of elders. Then through the elders outdoor activities, walking time path and space facilities and gives the suggestion of the needs for the elders.

After that, analysis the social support from the elders outdoor activities, and found out the needs for the pedestrian way and social support, later check the aged friendly city checklist of WHO to add or remove the list. In the end, this research could be the landmark of the urban planning in the future.

Table. 3 Pedestrian space, social support and aged friendly city checklist

Type	Pedestrian space	Social support	aged friendly city checklist
Social type			

Service type	1.Safety street at the night 2.The availability of bus stop 3.To create more communicate space in the neighbourhood	1. Information support at the bus stop. 2. provide more indoor activity space	1. Night lighting and sound tips on the pedestrian way. 2. Provide checklist of natural pedestrian way 3. Provide more indoor activity space in the public space.
Sport type	1.activities space connecting safe streets 2. Provide seating area.	1. Information support at seating area. 2. provide more indoor activity space	1. Provide checklist of natural pedestrian way 2provide more indoor activity space in the public space.
Selection type			
Personal activities	1. Provide seating area. 2. provides more activity facility	1.provides a gathering place for exchange within range five minutes walks	1. Provide seating area in Arcade 2. Provide more shops near to the activity space.
Sport type	1. Provide seating area. 2. provides more activity facility	1.provides a gathering place for exchange within range five minutes walks	1. Provide seating area.
Religious type	1. Religious space entrance could be use by elders.	1. Provide more communicate area near to the Religious buildings	1. Increase in religious building entrance accessibility projects.
Necessary type	1. Facilities are comfort, with the Shelter.	1. Provide more activities in the neighbourhood parks and facilities	1. Provide more activities area in the neighbourhood.

According to the table 3, form the needs of the pedestrian way and social support to organize the aged friendly city checklist. That found out to provide more activity spaces and rest area can improve the social support for the elders. Social type of elders needs more indoor activity space, and more communicate space near by the pedestrian way. Selection type of elders needs the shops, sport facilities, and communicate space. Necessary type of elders needs the communicate space in the neighbourhood park, and plaza.

Besides that, to consider the Elderly body functions THAT SUGGESTS removing the Flyovers, underpasses, large parking lot.

4. CONCLUSION

This research use the Age-friendly Cities Index to analysis the walking path and activity space with 22 elders, and to discuss the social sport. Then

found out the needs to be improved and fixed, and provides the walking space planning of Xinyi District in the future, the results are as follows:

There are three types of outdoor activities for the elders in Xinyi District form most to the least are selection type, social type and necessary type. Social type of elders has the longest walking distance, and they use the public transportation really well. Therefore, the community could create more “nodes” such as the bus stop or other transportation and communicate space on the pedestrian way. Selection type of elders spends the shortest time for walking, because they use the Vehicles and public transportation well, so to provide more trees and shelter around the pedestrian streets and bicycle paths, can enhance the safety and healthy for the outdoor activities.

Necessary type of elders has the shortest walking distance, but spends the longest time; their activities are limited by the neighbourhood parks and markets. Therefore, can be planned the social space to improve their social supports for this type of elders.

4.1.1 The recommendations of social activities supported for the elders:

4.1.1.1 Planning to improve travel

Providing information support at the bus stop, and public places for the elders, and to provide the communicate space in the activities area.

4.1.1.2 The integration and connection with the pedestrian way:

The recreation, rest communication space and shop. Also, provide the small communicate point around the religious building.

4.1.1.3 To create more communicate activities field:

To create more communicate activities field in the neighbourhood and parks, and the Community Centre most have enough of activities with the group work and other facility to support the elders to participate.

REFERENCES

- Robertson,K.A.(1994)."Pedestrian Mall and Skywalks" , Avebury , England
- Bronfenbrenner,U. (1986).","Ecology of the family as a context for human development : Research perspectives". *Developmental Psychology*,pp.723-742
- Sugiyama,T.,Lesile,E.,Giles-Corti,B.,&Owen,N. (2008).","Association of neighbourhood greenness with physical and mental health: do walking, social coherence and local social interaction explain the relationships? " ,*Journal of Epidemiol and Health*,62(5)
- Mary Kihl et al., (2005).""Liveable Communities: An Evaluation Guide ",AARP Public Policy Institute.
- Michael,Y.L. (2005).,"Neighbourhood design and active aging ",*Health & Place* ,12(4) pp,734-74,
- Gehl, J.(1987). " Life between buildings-Using public space" ,
- Dieter Prinz.(1997)「圖解都市計畫」,蔡燕寶譯,詹氏書局。
- Hsin-Li Chang, and Yi-Chieh Shen.(2005) "People's Intention to Walk – A Case Study for Taipei Citizens" *Journal of the Chinese Institute of Transportation* Vol. 17 No. 3 Sept. 2005, pp. 233-260
- Jen-Fen Chen and Zin-Rong Lin (2006) "Relationship between Physical Activity and Quality of Life for the Community Older Adults" *Physical Education Journal National Society of Physical Education, Taipei , Taiwan* Vol. 39, No.1 , pp. 87-100
- Tsung-Chang Chang & Chih-Sheng Yu(2008) "Discussion on Walking Exercise's Benefits of Leisure"
- Ying Zhao, Yan-Wei Chai, Jie Chen, & Xiu-Jun Ma (2009). "GIS-Based Analysing Method for Spatial-Temporal Behaviour Data" "*Geography and Geo-Information Science*"Vol.25 No.5
- Ko,Hsin-Yi (2012) "Effects of The Brisk Walking Exercise on Physical and Mental Health Promotion for Middle-Aged and Older Community Residents" pp.159-172
- Jen-Jia Lin, & Siao-Yu Sun (2012) " A Location-Allocation Model for Senior Citizens Communities Planning" "*Journal of Architecture & Planning*" P1 – 26
- Tung-Yu Liu , Kuang-Pang Lai, & Tsai-Fang Lu (2012) " A Study on Pedestrian Space System of Planning Criterion in a New Community Development Area " *Journal of space Design*" P31 – 64
- Chu-Yin Huang (2005) " The Neighbourhood Environment for the Elderly: A Study of Nan-Ji-Chang Apartment Area, Taipei. master's dissertation of national Taiwan university
- Hsu, Keng-Hung(2007) " A Study on Walking Space of Urban Communities"
- Hsing-Chang Hu (2007) " The Construction of Downtown Pedestrian System of Traditional Tainan City" master's dissertation of Department of Urban Planning of National Cheng Kung University
- Chia-Wen Wang (2009) "The Effects of Neighbourhood Environmental Patterns on the Physical Activity Patterns of Residents in Taiwan. master's dissertation of Yang Ming university pp.27-32 ,
- Shiao-Ying Hsu (2009) " Urban Spatial Planning and Everyday Life Practice of Family Commensality" master's dissertation of Department of Urban Planning of National Cheng Kung University
- Chang-HongOu-Yang(2009) " Developing a Physical Environment Assessment Indicator System for Ageing-Friendly Community : an Empirical Study of Guangci Community " master's dissertation of Department of Urban Planning of National Cheng Kung University

NO.47

Detecting the Urban Dynamics with Taxi Trip Data for Evaluation and Optimizing of Spatial Planning: *The Example of Xiamen City, China*

Longzhu Xiao¹, Wangtu Xu^{1*} and JixiangLiu²

1 School of Architecture and Civil Engineering, Xiamen University

2 School of Urban Planning and Design, Peking University

** Corresponding Author, Email: ato1981@163.com*

Key words: Taxi trip data, Urban dynamics, Spatial planning, Xiamen

Abstract: A number of cities in China are undergoing rapid urbanization and quick society change process, which highlights the failure of traditional spatial planning in arranging individual travel behaviour by means of mere construction of physical environment. Besides, it is very hard to examine the underlying urban dynamics due to the rapid spatial expansion and land use variations. Changes and improvement are imperative. Fortunately, in recent years, the availability of big data which conveys human behaviour and mobility information makes the detection of urban dynamics possible and throws light on the evaluating and optimizing of spatial planning. In this paper, the origin-destination (OD) data extracted from the taxi trip data collected in Xiamen, China, covering 30 days was utilized to detecting the underlying dynamics of Xiamen City. Specifically, we discretized the study area into 400m*400m grids so that the number of originating points and destined points of the taxi trips could be counted separately within every single grid. Then, the heat maps of the taxi mobility were made to achieve a general understanding of urban dynamics. And we extracted daily taxi trips from taxi trip data for further analyse. Secondly, we took advantage of the concept of complex network to analyse the daily taxi trip data extracted formerly. And with the method of community detection, we divided the study area into 6 main sub-regions called functional self-sufficient zones (FSZs) in which spatial associations are tight and dense. The features of these FSZs helped us to gain a deeper understanding of urban dynamics. Finally, basing on this understanding, we furthered evaluating and optimizing urban spatial planning of Xiamen. Balancing land use allocation was suggested to enhance the multi-centric structure and reduce congestion. Moreover, the effect of rail transit planning was suggested to reconsider. And thus, we gave some suggestions in optimizing the spatial planning. This study could do the relevant contribution by exploring the potential of applying the taxi trip data into urban dynamics revelation and urban planning optimization.

1. INTRODUCTION

Spatial planning is the most traditional and widely used planning paradigm in China, and is with the strongest legal effect. While compared with the modern western urban planning, which quantitatively analyses and solves urban problems through building a vigorous index system (Alexander, E. R. (2000); Benevolo, L., and Landry, J. (1967)), spatial planning in China has been relatively more subjective and drawing too much attention to aesthetics. Traditional spatial planning has been trying to arrange individual travel behaviour by means of mere construction of physical environment. However, such arrangements on the future city life seem to fail in achieving the goal of “better city” that the political and professional elites have been expecting. This kind of failure has aroused wide discussions in academia as a result, which, nevertheless, were replete with subjective experience seldom give birth to a revolution of urban planning theory. And there are few empirical researches evaluating and examining the rationality and effectiveness of proposed planning objectively and quantitatively. In addition, the fact of sharply expanding urban scale and increasing unpredictability and complexity has been making understanding urban dynamics and evaluating and optimizing urban planning quantitatively more difficult.

Fortunately, in recent years, the high availability of the big geospatial data such as cell phone data, public transportation card records and taxi trajectories has boosted the researches on the detection of urban dynamics. (Lu, Y., and Liu, Y. (2012)). Compared with other public transportation such as bus and metro which are constrained to prespecified routes, taxi travel can freely reach many spots which others can't. Moreover, taxi trip data can reflect people's activities through the information of spatio-temporal connection of origin and destination. Taking advantage of the diversity of routes as well as accurate spatio-temporal information, taxi trip data offer a richer and more detailed glimpse into the human mobility patterns (Liang, X., Zheng, X., et al. (2012); Wang, W., Pan, L., et al. (2015)) which are manifestations of urban dynamics. Human mobility studies based on taxi trip data enable applications in many other fields, such as traffic management (Yuan, N. J., Zheng, Y., et al. (2013)), urban structure (Liu, X., Gong, L., et al. (2015)), and land use analysis (Pan, G., Qi, G., et al. (2013); Peng, C., Jin, X., et al. (2012); Yuan, J., Zheng, Y., et al. (2012)). But many relevant researches analysed the spatial distribution of the pick-up points and drop-off points individually, omitting the interaction between spaces. Furthermore, there have been few researches applying taxi trip data which conveys human behaviour and mobility information in urban planning evaluation and optimization.

Researchers have been utilizing various analytic tools to look into individual travel behaviour and urban dynamics. Improvement of

technology and computing capacity enables people to handle the whole urban travel data utilizing analytic methods, in which complex network is included. Complex network is characterized by community structure, that is to say, its overall structure consists of multiple communities. Newman, M. E., and Girvan, M. (2004) once defined community as “a sub graph containing nodes which are more densely linked to each other than to the rest of the graph.” Community in this context is able to demonstrate the underlying dynamics of cities, which are often omitted or surmised subjectively by traditional planning. Community detection can be considered as a process of dividing complex network into several sub networks among which the internal connection are extraordinarily close. Many researchers utilized community detection method in their researches. Gao, S., Liu, Y., et al. (2013); Roth, C., Kang, S. M., et al. (2011) and Liu, X., Gong, L., et al. (2015) all focused their researches on the detection of human mobility and urban structure utilizing various data. Liu, Y., Sui, Z., et al. (2014) analysed the underlying spatial interaction on a national wide scale. Austwick, M. Z., O’Brien, O., et al. (2013) once visualized bicycle sharing system’s structure in 5 cities. However, these researches failed in applying the revealed urban dynamics in planning practices.

In this paper, the origin-destination (OD) data extracted from the taxi trip data collected in Xiamen, China, covering 30 days was utilized to detecting the underlying dynamics of Xiamen City. Specifically, we discretized the study area into 400m*400m grids so that the number of originating points and destined points of the taxi trips could be counted separately within every single grid. Then, the heat maps of the taxi mobility were made to achieve a general understanding of urban dynamics. And we extracted daily taxi trips from taxi trip data for further analyse. Secondly, we took advantage of the concept of complex network to analyse the daily taxi trip data extracted formerly. And with the method of community detection, we divided the study area into 6 main sub-regions called functional self-sufficient zones (FSZs) in which spatial associations are tight and dense. The features of these FSZs helped us to gain a deeper understanding of urban dynamics. Finally, basing on this understanding, we furthered evaluating and optimizing urban spatial planning of Xiamen.

2. METHODOLOGY

2.1 Study area

Xiamen City was developing from an island city, and aims at developing into a coastal city. 2 out of 6 districts lie in and constitute the Xiamen Island, which is the exact core of Xiamen City, while the other 4 districts lie in the

mainland areas of Xiamen City and semi-surround the Xiamen Island (fig. 1). The spatial structure of a city can be depicted with the help of distribution of its hierarchical centers. Thus, according to *Master Plan of Xiamen City (2010-2020) (draft)*, which designated 2 municipal centers, lying in the Xiamen Island and east of Xiamen separately, and 6 district centers, namely Siming, Huli, Haicang, Jimei, Tong'an, Xiang'an, among which, Haicang, Jimei, Tong'an and Xiang'an form an urban corridor surrounding the gulf, we can clearly tell, in a word, Xiamen is going to develop into a city with multi-centric spatial pattern.

Thus far, there are 2 railway stations and 1 airport in Xiamen, in addition, an airport has been planned to be built in Xiang'an district. It is the buses, BRT, taxis and subway under construction that form Xiamen's public transit system, which serves a large proportion of the travels inside the city. Among them, taxi is an excellent supplement for the other transportation modes. Besides, taxi trip data can reflect a large proportion of individual travel habits, accordingly, is a great data source for research of urban dynamics.

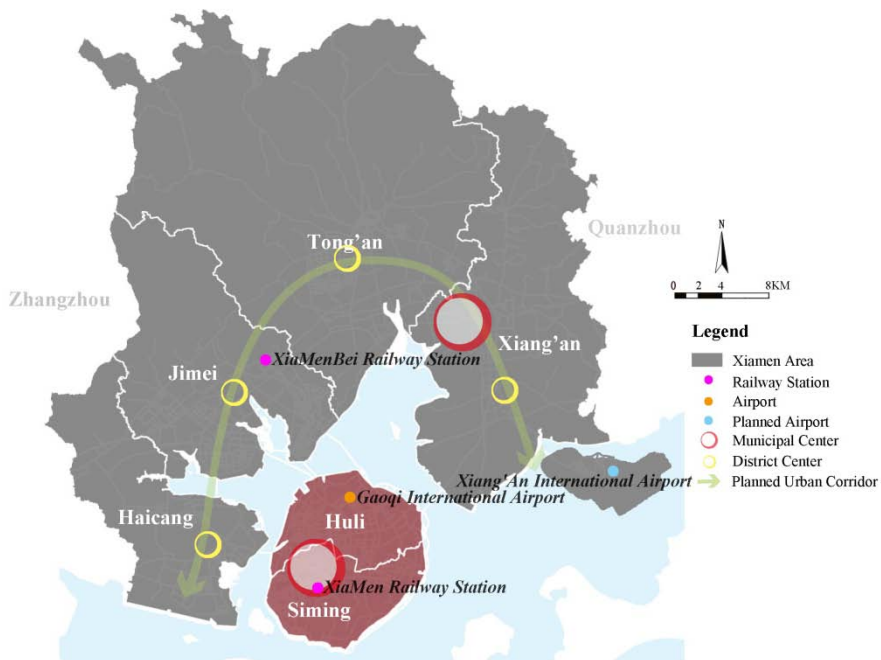

Figure 9. Study area of Xiamen

2.2 Research design

It's a very meaningful research to evaluate and enhance the newly

proposed spatial planning rationally and quantitatively, basing on individual travel behavior. With the help of analysis methods of community detection, this research expected itself to solve the following three problems:

1. How will taxi trip data help us to achieve a general understanding of the dynamics?
2. How can we take advantage of the complex network built basing on the origin-destination (OD) data which were extracted from the taxi trip data to understand the underlying urban dynamics?
3. How to guide and enhance the proposed urban spatial planning basing on the underlying urban dynamics revealed by taxi trip data?

The following analytical framework revealed the process to solve the problems above. (Figure 2). Firstly, a general understanding of urban dynamics was generated through observing spatial distribution of taxi trips amounts. And then we extracted daily taxi trips from taxi trip data. Secondly, we built a network using the daily taxi trips and analyze this network with the method of community detection to gain a deeper understanding of urban dynamics. Furthermore, evaluation and suggestions for proposed urban planning were constructed basing on the preceding analysis.

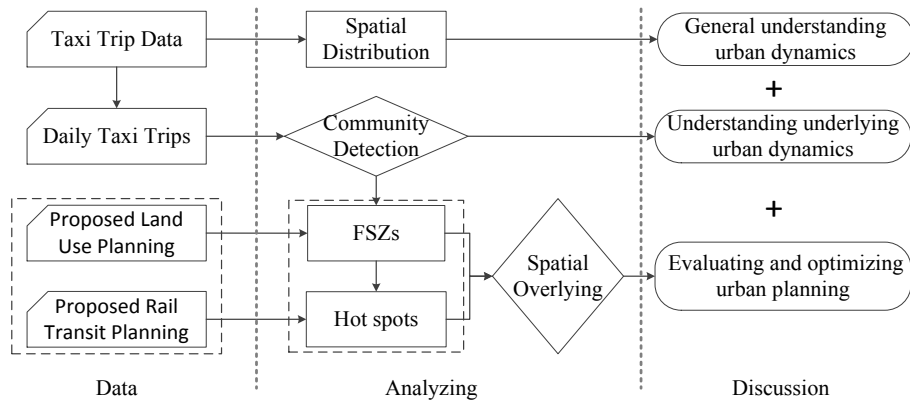

Figure 2. Analytical framework

3. ANALYSES

3.1 General understanding of urban dynamics and daily taxi trip data extraction

3.1.1 Data pre-processing

The taxi trip data (in 30 days) was used to examine urban dynamics. There were nearly 3 hundred thousand taxi trips records on average every

single day, and each taxi trip record in the data was composed of key information like taxi ID, Original point coordinates, Destination point coordinates and trip length. Additionally, we removed the invalid records such as those with a trip length less than 500meters or beyond the administrative boundary of Xiamen.

The urban dynamics are closely related to daily travel behaviour, therefore, there's great need that we extract daily trips data from the whole data.

3.1.2 Analysis of taxi trips on weekdays and weekends

We used two types of taxi trips data: the working day data and weekend day data. Specifically, we discretized the study area into 400m*400m grids so that the number of origination points and destination points could be counted respectively within every single grid. Then, we carried out the amounts distribution of taxi trips in different grids (fig. 3) and heat maps of the taxi trips dynamics (fig. 4) on weekdays and weekends separately, which enabled us to achieve a general understanding of the dynamics of the whole Xiamen City. It can be inferred that individual travel behaviour is more random on weekends, while is with more regularity on weekdays. Accordingly, we selected the taxi trips of 4 consecutive days from Monday to Thursday as the samples that we studied the daily travel behaviour with. Despite a kind of weak trend of outward expansion, we also learned there is a high-centric urban functional area within the Xiamen Island. Further studies are still required to understand the underlying urban dynamics.

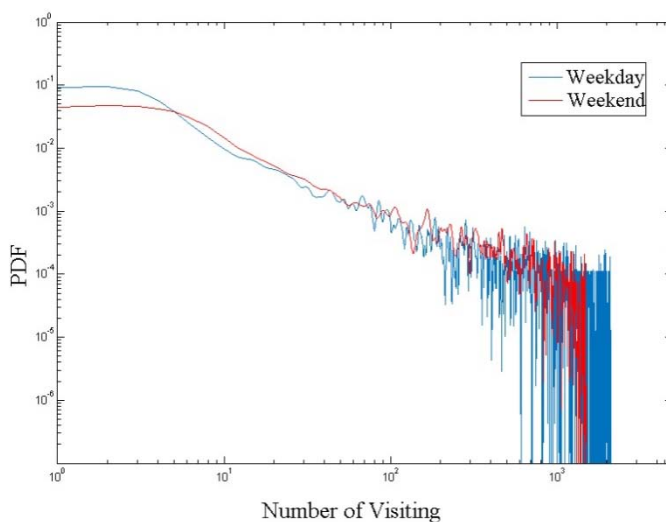

Figure 3. Log-log plot of the taxi trip amounts distribution of different grids on weekdays and weekends

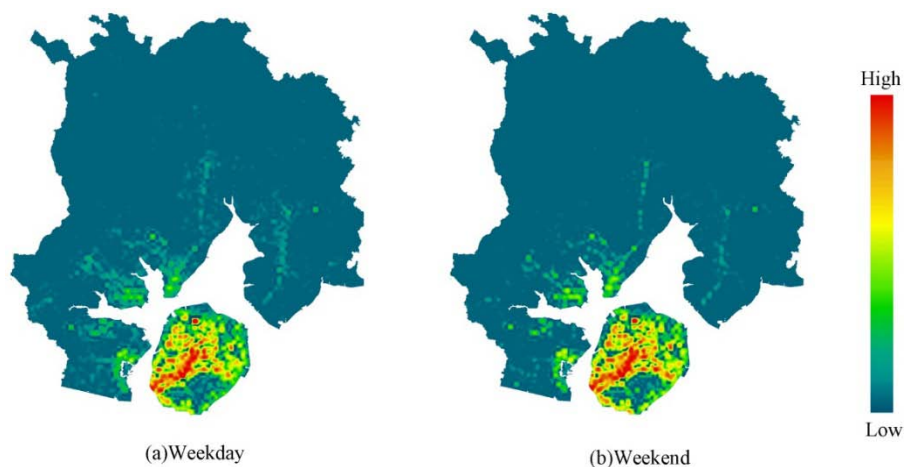

Figure 4. Heat maps of taxi trip dynamics on weekdays and weekends

3.1.3 Analysis of taxi trips of different length

When studying the taxi trips on weekdays, we found that the distance distribution of taxi trips tended to follow exponential laws in two distance ranges, the long length trips which were longer than 8 km and the short length trips shorter than 8 km (fig. 5). Among them, the short length trips accounted for 81.1%, while the total length of the short length trips accounted for 57.6% of the length of all the trips. People always travel with a purpose, and the purposes have a great influence on the taxi trips length. Daily travel behaviour such as commute, shopping and entertainment tends to be short length trips (fig. 6b), while particular travel behaviour like going catching the train or tourism behaviour from outside Xiamen tends to be long length trips. It was proved by a series of analyses that the short length trips on weekdays were able to represent residents' daily travel behaviour better than long length trips. The short length trips enabled us to observe the urban dynamics more deeply. Consequently, we furthered our study on detecting urban dynamics concentrating on short length trips.

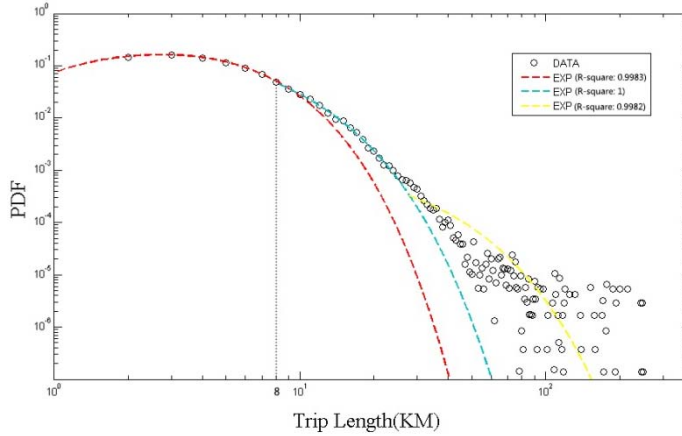

Figure 5. Log-log plot of the distribution of taxi trip length

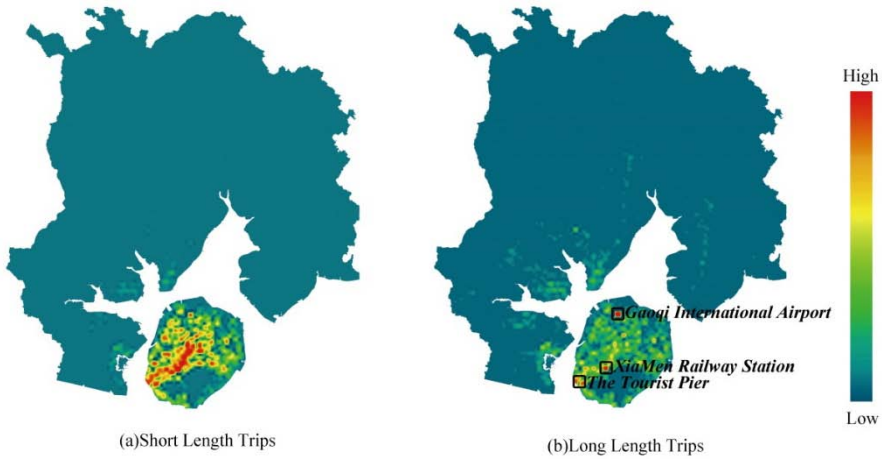

Figure 6. Heat maps of taxi trip dynamics of different length

3.2 Community detection and understanding of underlying urban dynamics

3.2.1 Network construction and community detection

Taking study area as a graph, we built a complex network on the graph with the origin-destination (OD) data which were extracted from the daily taxi trip data. The divided grids represented the nodes in the network, and edges represented the connection among them. The size of a grid was determined as 400m*400m, through which redundant connection within the

grids can be avoided.

The graph can be divided into several sub graphs applying community detection in which taxi trips were more concentrated internally than externally, according to the characteristics of the complex network (Newman, M., Barabasi, A.-L., et al. (2006)). Community detection method is armed with many algorithms, such as Multi-level method and Spectral methods (Malliaros, F. D., and Vazirgiannis, M. (2013); Newman, M. (2013)). The Fast Unfolding algorithm is a graph partition method basing on modularity optimization. This algorithm enables itself to take direction and weight into consideration, which is suitable enough for research basing on taxi trip data. Simultaneously, it contains a kind of hierarchy structure, or in other words, intrinsic multi-level characteristic. We can define an appropriate resolution value according to the hierarchy and degree of clustering as needed (Blondel, V. D., Guillaume, J.-L., et al. (2008)). In this study, we defined the resolution as 0.5, and obtained a clustering result which was suitable for the research on Xiamen's urban dynamics.

The interaction among the spaces was influenced by land use types, demographic and other geographic factors (McLaughlin, 2012). Most of residents' daily travels were completed within the sub graphs, which indicated that the function within a sub graph can basically meet resident's travel demand. Therefore, we named the sub graph function self-sufficient zone (FSZ) in this study.

51 sub graphs were found and there are 6 main sub graphs namely FSZs according to community detection results. Most of sub graphs in rural area were small and had weak taxi traffic flows. Number of the nodes in these 6 main FSZs took up 91.93% of all the nodes. 4 out of 6 main FSZs lied inside the Xiamen Island, while other 2 were outside the island. And most of their boundaries differed from those delimited administratively. Clearly enough, the result of division indicates the polycentric structure of Xiamen.

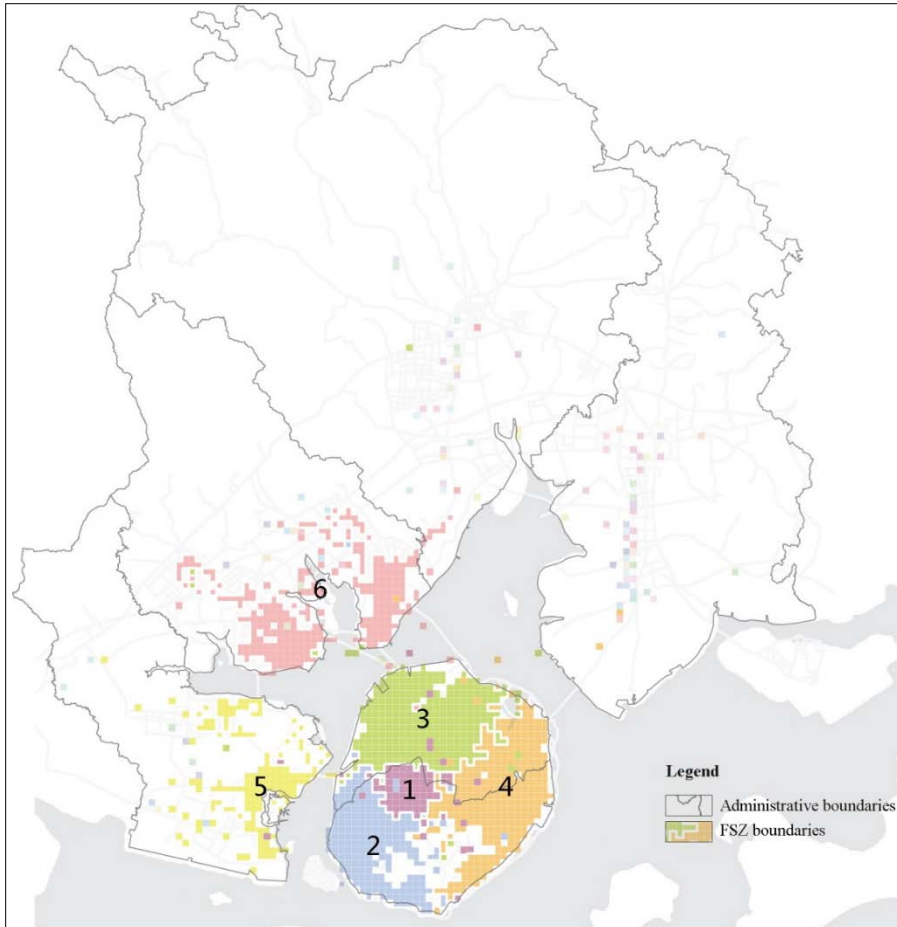

Figure 7. Function self-sufficient zones (FSZs) detection result based on daily taxi trips

3.2.2 Properties of the 6 FSZs and the hot spots

Studying into the properties of these 6 FSZs, we obtained the results shown in Table 1. Degree of a node represents the number of the other nodes connecting with it. Thus the average degree represents how closely nodes connected with one another. Weighted degree denotes the amount of traffic between a node and other nodes. Similarly, average weighted degree is the mean of weighted degrees of all the nodes, representing the allocation of traffic in every node. Graph density represents the degree of saturation or integration of the network. According to Table 1, the 6 FSZs can be divided into 3 groups. Specifically, group 1 is FSZ 1, which covers the least nodes, yet, is with the highest value of trips, average degree and average weighted degree. While group 2 consists of FSZ 2, 3, and 4, whose values of properties are relatively close. Finally, FSZ 5, 6 belong to group 3, and their

values are obviously lower than those of the former two groups. We can conclude that FSZ 1 is the exact core of Xiamen City, and that human travel mobility are concentrated inside the island largely, while the mainland areas of Xiamen City are far inferior to the Xiamen Island in attraction.

Table 6. Properties of the 6 FSZs

FSZs	Nodes	Edges	Trips	Average degree	Average weighted degree	Graph density
1	74	21362	78629	320	1278	0.048
2	198	18374	67535	184	684	0.042
3	274	29297	72206	148	370	0.057
4	279	23833	54867	117	267	0.048
5	149	718	1098	8.3	12.3	0.014
6	259	917	1207	6.6	8.3	0.009

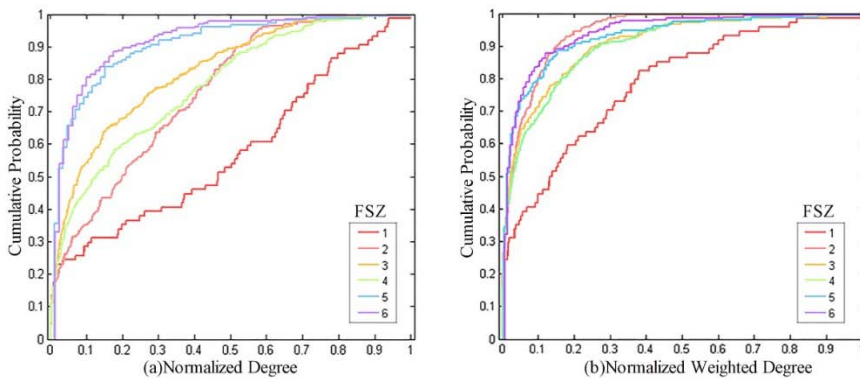

Figure 8. Cumulative probability of normalized degree (a) and normalized weighted degree (b) of the 6 FSZs

We further plotted cumulative probabilities of normalized degree and normalized weighted degree of nodes in the 6 FSZs (fig. 8). On the one hand, as shown in the figure, the properties of FSZ 2, 3, and 4 turned out to be similar, so did those of FSZ 5 and 6, which, again, proved the previous classification into groups to be reasonable. On the other hand, the figure itself enabled us to understand the imbalance of distribution of normalized degree. We noted that the cumulative probability increased fast in the beginning and gradually slowed down later, that is to say, there exist a few nodes with high weighted degree, which dominates taxi traffic flows of each FSZ. Furthermore, we located such nodes namely hot spots of each FSZ according to the distribution of weighted degree of each node (fig. 9).

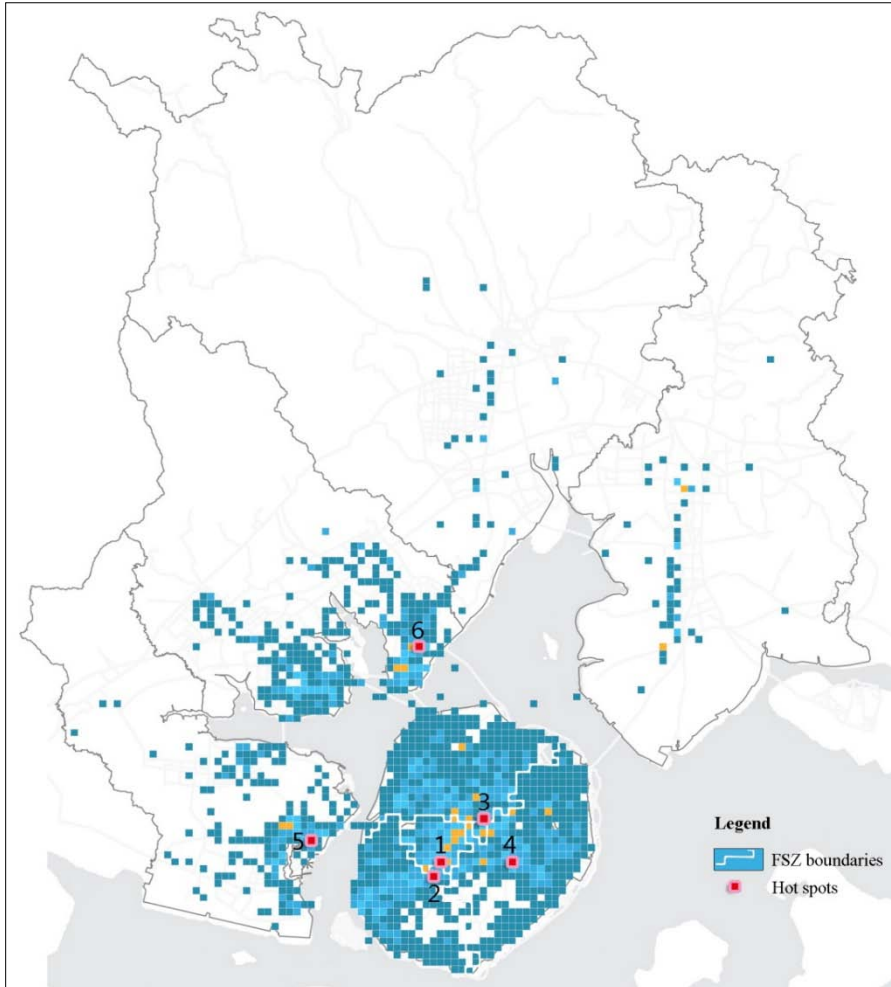

Figure 9. The spatial distribution of hot spots of each FSZ according to weighted degrees of each node

3.3 Evaluating and optimizing proposed urban planning

3.3.1 To achieve rational and effective allocation of land use in FSZs

The trips in FSZs accounted 65.1 percent of all the daily taxi trips, and the total length of such trips only took up 33.6 percent of that of all the trips. Thus, it can be inferred that reducing the trips especially long length trips among FSZs will ease traffic congestion and other urban problems

effectively. Then by what means can we reduce the trips among FSZs? The common solution is to form and enhance the multi-centric structure of the city by means of rational and effective disposition of land use which will cater to people's need of daily travel.

We analysed the proposed land use planning set by *Master Plan of Xiamen City (2010-2020) (draft)*, and then observed the discrepancy of the land use conditions within the 6 FSZs (fig. 10). Note that residential districts took a large proportion in the disposition of land use, specifically, 35 percent on average. When it comes to FSZ 1, whose acreage is the smallest, yet traffic flow the heaviest, the residential district took up an excessive proportion of 49 percent of land use disposition, thus leading to a kind of imbalance inevitably. Most of the FSZs own an appropriate proportion of commercial and recreational district, except FSZ 5, whose proportion is relatively small. As for the proportion of official district, a significant difference exists between on and off the Xiamen Island. Specifically, the mainland area of Xiamen City owns a far smaller proportion of official district than the Xiamen Island, which will probably lead to an excessive gathering of high-level talents toward the island. While, the fact that industries take a large proportion of land use disposition in the mainland areas of Xiamen City, and forms a settlement of workmen, will result in a kind of social differentiation to some extent. The results of our study could help urban planners and policy makers in adjusting sub-regional land use structure.

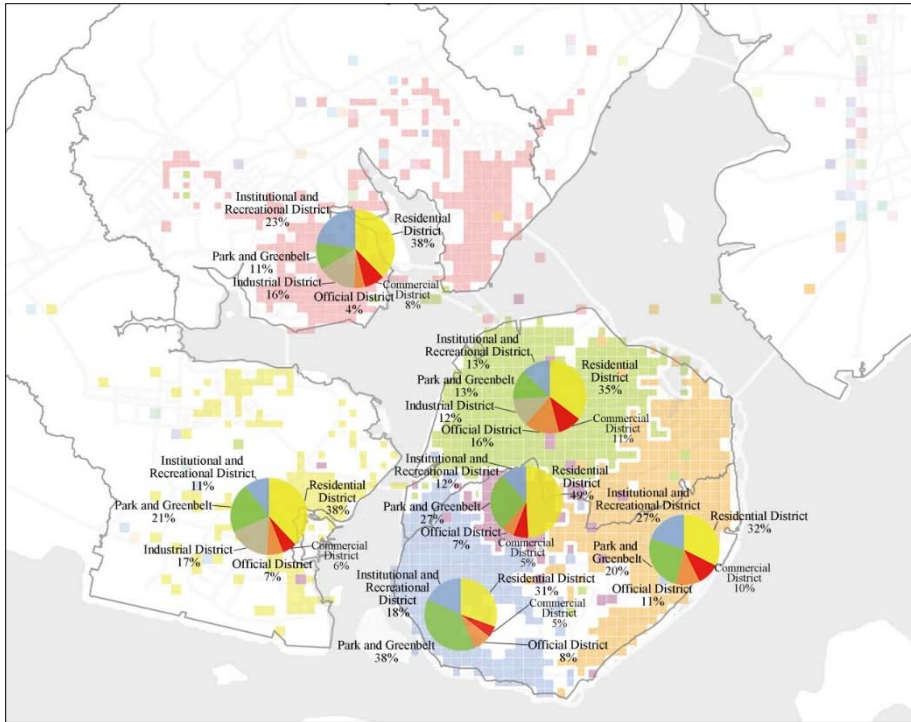

Figure 10. Comparison of planned land use conditions in the 6 FSZs

3.3.2 To achieve rational and effective rail transit planning

Rail transit plays a very important role in a city’s development, since it can ease traffic congestion on a large scale, moreover, it’s able to guide the development orientation of the city. With regard to these two kinds of significance, it remains a focus of controversy that we should value which one more in planning, in domain of either theory or practice. To understand the future development of Xiamen’s rail transit, we drew enough attention to *Xiamen’s immediate planning of urban rail transit (2011-2020)* which earned national official approval in May, 2012. As shown in fig. 11, we superimposed the planned rail transit lines to the 6 FSZs, and found that the hot spots of the 6 FSZs were all close to the planned rail stations, which implied that planned rail transit was helpful in easing the traffic congestion to some extent. To make a deep research on the properties of planned stations, we observed the degrees and weighted degrees of the nodes where rail transit stations located. The average weighted degree of the nodes where rail stations located was just slightly lower than that of all nodes, which denoted that the planned rail transit was not efficient enough in easing traffic congestion. While, the average degree of such nodes was

4. DISCUSSIONS AND CONCLUSIONS

Planning can lead the individual travel behaviour to some extent, yet, it's not able to arrange individual travel behaviour concretely without considering current situation. The city blueprint depicted by traditional spatial planning based on aesthetics can hardly come true. According to the former analysis, there is considerable disequilibrium between the development on and off the Xiamen Island. Clearly enough, the Xiamen Island has an absolute advantage in attracting people and activities, compared with the planned city center in the east of Xiamen City, in which poor-developed yet. Given that urban planning could achieve its original goal only when the target of urban planning matches the social reality, therefore, it's of great need to reconsider if the planning underestimated the aggregation effect of the old city center, and overestimated the effect of guiding the urban development outward the island. Taking the fact that Xiamen is a coastal city generated from an island city into consideration, it's necessary for Xiamen to develop outward the island. Therefore, it's necessary to enhance the multi-centric structure of Xiamen, which is still weak thus far, after all.

It's in western countries that rational planning has come mature, while in China, the planning industry has not yet accepted rational planning truly. However, there are an increasing number of scholars reflecting the traditional spatial planning and appealing to the application of quantitatively analysing which is objective and scientific in the planning progress. Moreover, access of diverse analysis platform and availability of big data has made it inevitable to some extent that urban planning transforms from a traditional spatial aesthetics to a modern spatial science.

We built complex network basing on taxi trip data, and apply community detection method, to deeply understand urban dynamics in this research. Then, we put forward evaluation and suggestions for proposed urban planning on the basis of quantified urban dynamics. This research can after all be considered an attempt of rational planning. It could do the relevant contribution by exploring the potential of applying the taxi trip data into urban dynamics revelation and urban planning optimization utilizing community detection method. However, since taxi is only one of the diverse ways of people's travel, limitation exists inevitably. Therefore, our future work should move forward merge of multiple data sources and methods.

REFERENCES

- Alexander, E. R. (2000). Rationality revisited: Planning paradigms in a post-postmodernist perspective. *Journal of planning education and research*, 19(3), 242-256.
- Austwick, M. Z., O'Brien, O., et al. (2013). The structure of spatial networks and communities in bicycle sharing systems. *PLoS one*, 8(9), e74685.

- Benevolo, L., and Landry, J. (1967). *The origins of modern town planning*: Mit Press Cambridge, MA.
- Blondel, V. D., Guillaume, J.-L., et al. (2008). Fast unfolding of communities in large networks. *Journal of Statistical Mechanics: Theory and Experiment*, 2008(10), P10008.
- Gao, S., Liu, Y., et al. (2013). Discovering spatial interaction communities from mobile phone data. *Transactions in GIS*, 17(3), 463-481.
- Liang, X., Zheng, X., et al. (2012). The scaling of human mobility by taxis is exponential. *Physica A: Statistical Mechanics and its Applications*, 391(5), 2135-2144.
- Liu, X., Gong, L., et al. (2015). Revealing travel patterns and city structure with taxi trip data. *Journal of Transport Geography*, 43, 78-90.
- Liu, Y., Sui, Z., et al. (2014). Uncovering patterns of inter-urban trip and spatial interaction from social media check-in data. *PloS one*, 9(1), e86026.
- Lu, Y., and Liu, Y. (2012). Pervasive location acquisition technologies: Opportunities and challenges for geospatial studies. *Computers, Environment and Urban Systems*, 36(2), 105-108.
- Malliaros, F. D., and Vazirgiannis, M. (2013). Clustering and community detection in directed networks: A survey. *Physics Reports*, 533(4), 95-142.
- McLaughlin, R. B. (2012). Land use regulation: Where have we been, where are we going? *Cities*, 29, S50-S55.
- Newman, M. (2013). Spectral methods for community detection and graph partitioning. *Physical review E*, 88(4), 042822.
- Newman, M., Barabasi, A.-L., et al. (2006). *The structure and dynamics of networks*: Princeton University Press.
- Newman, M. E., and Girvan, M. (2004). Finding and evaluating community structure in networks. *Physical review E*, 69(2), 026113.
- Pan, G., Qi, G., et al. (2013). Land-use classification using taxi GPS traces. *Intelligent Transportation Systems, IEEE Transactions on*, 14(1), 113-123.
- Peng, C., Jin, X., et al. (2012). Collective human mobility pattern from taxi trips in urban area. *PloS one*, 7(4), e34487.
- Roth, C., Kang, S. M., et al. (2011). Structure of urban movements: polycentric activity and entangled hierarchical flows. *PloS one*, 6(1), e15923.
- Wang, W., Pan, L., et al. (2015). A comparative analysis of intra-city human mobility by taxi. *Physica A: Statistical Mechanics and its Applications*, 420, 134-147.
- Yuan, J., Zheng, Y., et al. (2012). Discovering regions of different functions in a city using human mobility and POIs. Paper presented at the Proceedings of the 18th ACM SIGKDD international conference on Knowledge discovery and data mining.
- Yuan, N. J., Zheng, Y., et al. (2013). T-finder: A recommender system for finding passengers and vacant taxis. *Knowledge and Data Engineering, IEEE Transactions on*, 25(10), 2390-2403.

NO.68

Multi-Objective Evaluation Methods on Urban Transportation Efficiency

Jue Ji^{1*} and Xiaolu Gao¹

1 China academy of sciences

** Corresponding Author, Email: jitung99@163.com*

Key words: Travel efficiency, multi-objective evaluation, carbon emission, travel convenience, travel behaviors

Abstract: Reducing daily transportation carbon emission and improving people's travel convenience seem main tasks at present for accomplishing sustainable transportation. Transportation development in future should pay close attention to both travel convenience and its negative effects to environment, such as the carbon emissions. This paper will adopt the multi-objective evaluation method to evaluate the traffic efficiency based on travel behaviors.

It is commonly agreed that the preference or behavior of people ought to be examined with specific geographical contexts. This study firstly proposes the concept of 'behavior zone' (BZ) based on homogeneous assumption of behaviors, in order to analyze people's traffic behavior and its carbon emission and travel satisfaction effect. This special scale can provide an appropriate spatial unit for integrating people's greatly diversified behaviors, which can make use for analyzing the general impact of personal behaviors on transportation carbon emission and transportation convenience. With a survey analysis of the characteristics of people's daily trips in Beijing's sample residential areas, the critical indices of Behavior communities are identified, including second-hand housing price, development intensity, population density, accessibility to public transportation, and so on. With these indices, Beijing is classified into five representative behavior communities, where the modal choice behaviors of inhabitants are projected. Then, this paper introduced quantitative models to estimate carbon emission and traffic convenience, and synthetic methods of carbon emission and transport convenience based on BZS. Through the case of Beijing, traffic efficiency is still has the central and outside pattern, that is the efficiency is lower outside the 5th ring road, and higher inside the 3rd ring road. Especially, there are several clusters of higher and lower traffic efficiency. The higher clusters are located in: (A) Gong Zhu fen-Wukesong district around the west ring road. (B) An zhen bridge nearby in the north 3rd ring road. (C) San litun district in the east 3rd ring road. The lower clusters are located in suburban spaces, such as northwest of 6th ring road, areas among 5th and 6th ring road in the southwest, and Changying district outside the 5th

Infrastructure & Transportation Planning

ring road in the east. Besides, spatial differences of transport efficiency in Beijing have close relationship with geographic context. High carbon emission is the main cause of low travel efficiency; this is especially true in the area where luxury-villa located, and in the subarea where the service quality of public transportation is relatively low. High proportion of car use and long commuting distance is the main cause of high carbon emission. In future, the construction of public transportation, especially the optimization of subway, will improve the spatial distribution of travel efficiency.

NO.87

Water Infrastructure and Land Use Smart Planning MC-SDSS APPROACH

Isidoro Fasolino¹, Michele Grimaldi^{1*} and Vincenzo Pellecchia^{2*}

1 Department of Civil Engineering, University of Salerno

2 Water Management Authority AATO

** Corresponding Author, Email: migrimaldi@unisa.it ; v.pellecchia@atocaloreirpino.it*

Key words: Spatial Decision Support Systems, Analytic Network Approach, Spatial Analysis, Water Planning

Abstract: The need to protect water resources, consistent with the object to pursue a sustainable settlement development, brings out the need for smart planning of water infrastructure, because these infrastructures requires a strategic and long-terms investments, with the interest of large capital expenditure, designed for many years of service. System planning of urban infrastructure at regional scale has important spatial implications. Emerge so the need to integrate it with the urban planning at the local scale. Given the spatial nature of the urban infrastructure planning, is presented a Multi-criteria Spatial Decision Support System (MC-SDSS) that integrates methodologies of three research areas: geographic information systems (GIS), data base management systems (DBMS), and multi-criteria decision analysis (MCDA). In particular, because of the relationships between the instruments of regulation and planning, these are compared by multi-criteria spatial analysis type network, ANP. This method, tested on a sample of the City Southern Italy, allowed to optimize the design and the location of investment needed to meet the criteria of service, looking at the actual efficiency of the networks. The result of such application is a map of suitability that allow to validate the criteria for define the urban transformations.

1. INTRODUCTION

The demand for water is increasing significantly in all major sectors: agriculture, energy production, industrial uses and human consumption; The latest report of the United Nations (UNESCO, 2015), estimates that in contrast to this increase in demand, the availability of fresh water in many regions, is likely to decrease due to climate change and that these pressures will exacerbate economic disparities between some nations, and between sectors or regions within countries.

In numbers, of all the water on our planet only 2.5% is fresh water. Of this one the 70% is in the form of ice, 29% is present in the soil, and only 1% (0.007% of the total) is readily accessible for human uses. If we think then that, of this water, on average, more than one third is lost even before reaching the final consumer, is not difficult to understand the reason for all the attention drawn by the argument.

The main source of demand comes from urban communities that need water for daily use. But water is not only this, it is not only the primary source of livelihood for humans, it is also the raw material needed for the production of energy, goods and services.

This demand, in a cyclical logic, results in a pollution load to handle, dispose and treat.

The demand for water is growing at a rate twice that of the population, and therefore the resulting pollution load produced by the use of water grows in the same proportions.

When you consider that population growth will focus, in the coming years, in urban areas and that to this additional need they will summed a previous one due to a backlog of people still to be served, there will be considerable difficulties in planning a system that as first has to be adequate in relation to the future forecast and later expanded as needed.

To meet the need to ensure sustainable expansion, to operate efficiently and to maintain a high quality of life for residents, the city will have to approach this type of problem in a smart logic.

Making cities smart, to support its own growth, is emerging as a key activity for which, according to the report of Navigant Research, in this decade, they will invest \$ 108 billion in smart city infrastructures, and the water infrastructure is right among the six key areas of smart cities. (Navigant research, 2011).

The water, therefore, should not be seen only as a resource to be protected but as integrated infrastructure, to plan properly in order to preserve the resource and make its use sustainable with the simultaneous optimization and reduction of investment costs otherwise unaffordable for the deficiency in the system.

Today the management and use of the resource is organized in an integrated system of infrastructure that goes from the uptake, distribution, disposal and treatment of water, all those infrastructure involve large capital, for construction and management, and are designed for long periods of service.

So emerge the need to rationalize the system starting from the sewer sub-sector, which if not properly sized and managed, can itself become a contributory cause of pollution of the resource that we are trying to protect.

1.1 Water Service in Italy

The Italian water services, are suffering a significant infrastructural deficit, both in terms of quality and quantity of supply, and in both the sewage and water treatments. Even in the field of measurement systems and in control computer systems are required urgent investments and adjustment of the coverage and the service levels.

Added to this, there is the commitment to the reconstruction of the infrastructure at the end of its useful life, the extraordinary maintenance and the technological upgrading needed for the recovery of operational efficiency, for saving water and energy in systems and networks, to combine safety, quality and continuity of service, environmental protection and sustainable use of the resource.

Rating Agencies in this sector estimate, in scenarios "no growth", a requirement of investments around €1.6 billion each year as net capital that in the next 30 years will grow on average until the minimum threshold of 20 billion €/ year (Utilitatis, 2014).

In such a context, it is of fundamental importance the planning of needs and implementation of investments, considered as the engine to achieve the goals of quality, affordability, efficiency of service and, not least, the protection of public health and of the environment.

In addition, the new system for regulating the water rate, made by the National Authority for the Regulation of Electrical Energy, gas and Water System (AEEGSI), introducing the model of full cost recovery, makes it even more clear the need to avoid unnecessary or poorly sized investments, as would in any case be refunded to the Service's Companies but paid by users, both in economic and environmental terms.

1.2 Spatial and Urban Planning System

The need to protect water resources, imposed by the European Water Directive (2000/60/CE), consistent with the objective to promote sustainable settlement development, brings out the need for smart planning of urban infrastructure that, at regional scale, has important spatial implications.

In fact, the protection and use of water resources are not independent activities from those of land use, rather, these are reciprocal, consequential and necessary.

However, from the analysis of the Italian system of planning, you can see that the spatial and urban planning instruments that deal with land use and population, and the protection of the resource, are not related with the Water Infrastructure Plan, instrument that lead the Integrated Water System and then the use of the water resource.

Infrastructure & Transportation Planning

There are several critical issues that currently affect the planning system so described, and are:

- Lack of sufficient data to characterize the whole system of the service networks consist of many elements, made at different times and with different states of use and efficiency;
- Estimation of the demand of service that currently the Water Infrastructure Plan perform independently without considering the estimation made by the City Plan in charge for the settlement development;
- Lack of a spatial location of the service demand;
- The absence of a spatial location of the investments eventually needed;
- Lack of feedback towards City Plan;

So emerge the need for an integration between the responsible planning of the investments of the Water Infrastructure System and urban planning at the local scale.

1.3 Objectives and Proposal

The goal then is to propose a reorganization of the planning system, in this sector of studies, using the input-feedback mechanisms between the Water Infrastructure Plan and the City Plan, in view of a smart integrated planning.

Only the synergy, between these two levels of planning, allows to reach the coveted objectives of effectiveness, efficiency, economy and environmental sustainability of the service.

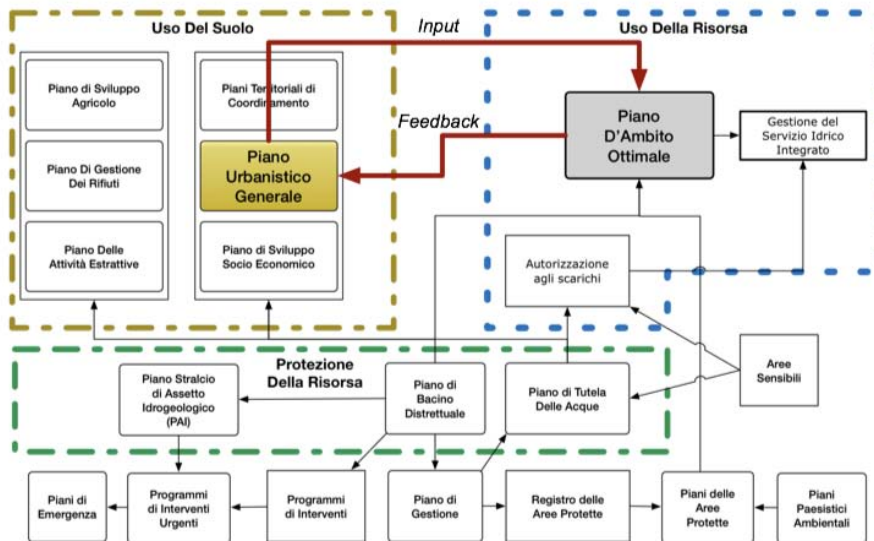

Figure 10. Italian Planning System. In red are visible the links object of study.

Given the nature of the spatial planning of urban infrastructure, is presented a Multi-criteria Spatial Decision Support System (MC-SDSS) that integrates methodologies of three research areas: geographic information systems (GIS), data base management systems (DBMS), and multi-criteria decision analysis (MCDA) (Malczewski, 2006).

In particular, because of the relationships between the instruments of regulation and planning, these are compared by a multi criteria spatial analysis of network type, ANP. (Saaty, 2003); Saaty, Vargas, 2006).

2. MATERIALS AND METHODS

2.1 Case Study

This study refers to the analysis of the suitability of the area and the existing sewer system to the location of new users or expansion of the service for the City of Capriglia Irpina (AV), included in the Water Management Area - ATO "Calore Irpino". The Water Infrastructures Plan for the sample area is sizing investments in expansion of the residential service with a parameter that represents the supplied services, considered constant at municipal level, and equal to the ratio between the length of the sewer system and users currently served and declared by the Water Company.

The aim of the Water infrastructures Plan is to increase the coverage of the service that in the year 2026 is estimated in 82.49% up to values above

90%, providing investments in expansion of the network for an additional lengths of 2.8km and an amount of € 1'208'500,00.

The City Plan instead provides an increase of the load settlement in terms of new inhabitants distributed in areas dedicated to the residential function as well expansion areas for the non- residential functions.

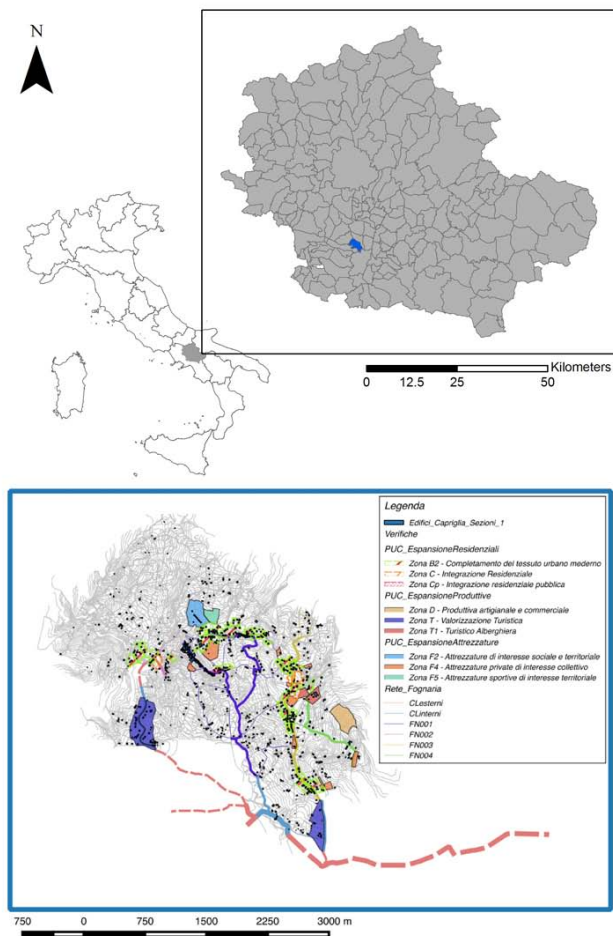

Figure 11. Area of studies

2.2 Spatial Decision Support System

Decision-Support System are used to assist governments and communities, helping planners organizing, analyzing, editing, and re-evaluation of information under the control activities of urbanization.

Regarding the DSS the expression "Multi-Criteria Analysis" embraces a set of mathematical tools for decision support that are able to compare different alternatives on the basis of multiple criteria, often in conflict with each other, in order to identify the preferred action, improve the awareness of decision makers and to provide rational support to problems of a complex nature (Figueira et al., 2005; Roscelli, 2005).

But if we consider that 80% of the data on which the decision-making is based has a spatial nature, in some cases, the only Multi-criteria Analysis are not enough to deal with complex issues such as the one presented here.

To overcome this difficulty we need to use GIS. (Worrall and Lew, 1991).

A GIS is a S ystem Hardware/Software that allows you to collect, process, manipulate, analyze, model and represent geo-referenced data with the aim of solving problems of management and planning. In this case, allows processing of reference data, of the information on the state of the environment, of the natural resources, land and infrastructure, and the positive and negative interactions between contexts and the main areas of development.

GIS alone, fail in the role of Spatial Decision Support Systems (SDSS) in particular because:

- there is a full consideration of the solutions proposed by the Decision Maker: current GIS accept in fact only quantitative criteria and ignore the qualitative ones based on the feelings of the DM (Malczewski,1996);
- analytic functions in most GIS are oriented towards the data management rather than towards an effective analysis of the same (Borrough, 1986; Goodchild, 1993);

So from the integration of GIS systems, MCDA and DBMS, which instead concerned with the management of data, are born Multi Criteria-Spatial Decision Support System.

2.3 ANP - Analytic Network Process

Given the interdisciplinary nature of this type of studies, the various topics, variables and criteria as well as the need to analyze spatially the demand of service, and in particular, its interaction with the territory, we have chosen, between Multi Criteria - Spatial Decision Support System (MC-SDSS), to use the Analytic Network Process (Bottero and Ferretti, 2011).

The ANP is incorporates both qualitative and quantitative aspects of human thought: the first in the expression of value judgments and preferences and the second in the structuring of the problem.

Precisely because of the nature of the links between the criteria and the environments analyzed, the ANP, is the methodology that allows the best benchmarking and that provides more than acceptable results respects to other techniques MCDA.

The ANP is a generalization of the famous method Analytic Hierarchy Process, certainly more widespread, but many decision problems, as in this case, cannot be structured hierarchically because they involve the interaction and the dependence of the elements of the upper level in a hierarchy with elements of lower level (Saaty and Özdemir, 2005).

While the AHP is a framework with hierarchical relationships uni-directional, ANP allows complex interrelationships between decision-making levels and attributes (Yüksel and Dagdeviren, 2007), which correspond to clusters and nodes of the decisional network.

The ANP includes four phases (Yüksel and Dagdeviren, 2007):

- Step 1, *Modelling and structuring of the problem*: the problem should be stated clearly and decomposed into a rational system of network type;
- Step 2, *Comparison between pairs and vector of priorities*: In ANP, as A HP, pairs of decision-elements for each cluster are compared, with respect to their importance, to their control policies. Moreover, interdependencies between criteria of a cluster must also be examined in these couples; the influence of each element on other elements can be represented by an eigenvector. The relative importance values are determined by the scale of Saaty.
- Step 3, *Making Supermatrix*: Supermatrix The concept is similar to the process of Markov chain. To achieve global priorities in a system with interdependent influences, vector of local priorities are incorporated in the corresponding columns of a matrix. As a result, a Supermatrix is actually a partitioned matrix, the matrix in which each segment represents a relationship between two clusters in a system.
- Step 4, *Summary of criteria and priorities alternatives and selecting the best alternative*: The weights of the priority criteria and alternatives can be found in Supermatrix normalized (Figure 3).

$$W = \begin{matrix} & \begin{matrix} C_1 & C_2 & \dots & C_n \\ e_{11}..e_{1m_1} & e_{21}..e_{2m_2} & \dots & e_{n1}..e_{nm_n} \end{matrix} \\ \begin{matrix} C_1 \\ C_2 \\ \vdots \\ C_n \end{matrix} & \begin{bmatrix} W_{11} & W_{12} & \dots & W_{1n} \\ W_{21} & W_{22} & \dots & W_{2n} \\ \vdots & \vdots & \ddots & \vdots \\ W_{n1} & W_{n2} & \dots & W_{nn} \end{bmatrix} \end{matrix} \quad \lim_{k \rightarrow \infty} W^k$$

Figure 12. Super weighted matrix and its convergence to a matrix whose columns, all the same, represent, the vector of the priority between nodes.

2.4 Methodology

The methodological proposal involves the construction of a spatial decision support system for the evaluation of the suitability of territory to the location of new users or investment in the sewerage sector.

This procedure is developed in the following sub-phases (Sharifi and Rodriguez, 2002):

- Intelligence
- Design
- Choice
- Review

2.4.1 Intelligence

The phase intelligence consists in structuring the decision problem using a spatial ANP approach that through the use of thematic layers allows to analyze and support decisions in which coexist multiple objectives and among them competitive with a multiplicity of alternative solutions.

Specifically, the decisional network, according to the principle of decomposition of the problem, identifies four homogeneous clusters: Infrastructure Components, Land use Components, Positional Components and Environmental Components.

Each cluster is divided into specific elements (nodes), constituted by the results of spatial analysis developed in GIS environment, each representative of the solution to the problem posed, according to their point of view.

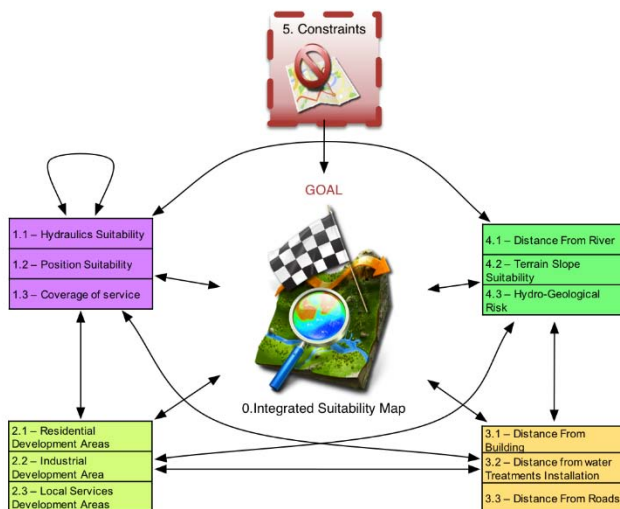

Figure 13. Decisional Network

Table 7. Questioning the Model – Goal according each criteria’s solution

Cluster	Node	Where to place new users or create new interventions in the sewer sector?
1- Infrastructure	1.1 – Hydraulics Suitability	Where it is already present a sewer system, but the same is under utilized.
	1.2 – Position Suitability	Where it already has a sewer system or where the network of services is more concentrated.
	1.3 – Coverage of service	Where required by the City Plan, with greater regard to the presence of the existing sewer system even in the condition that the value of the current service coverage is already high or higher than target of the Water Infrastructure Plan
2 – Land Use	2.1 – Residential Development Areas	In areas of completion and expansion planned by the City Plan.
	2.2 – Industrial Development Area	In areas of completion and expansion of production provided by the City Plan.
	2.3 – Local Services Development Areas	In areas of completion and expansion of equipment and services provided by the City Plan.
3 - Position	3.1 – Distance From Building	Closer to the buildings in the area, both within and among the non-served and served (new users in the same building).
	3.2 – Distance from water Treatments Installation	Much closer to the existing wastewater treatment plants in terms of distance on network (cost function).
	3.3 – Distance From Roads	Closer to the roads in the area.

Cluster	Node	Where to place new users or create new interventions in the sewer sector?
4 - Environment	4.1 – Distance From River	More distant from the rivers present in the territory.
	4.2 – Terrain Slope Suitability	In areas where the slope of the terrain can be compatible both with the development of new urban fabric, both with gradients necessary, from the hydraulic point of view, to the sewers network.
	4.3 – Hydro-Geological Risk	In areas where the risk hydrogeological can be compatible both with the development of new urban fabric and for receiving new user or network expansion.

Table 8. Spatial Analysis

Node	Input	Spatial Function
1.1	Lidar Elevation Map, Sewer Network Plan, Sewer Network's Diameters & Materials	Slope, Buffer, Distance, Raster Calculator, Field Calculator
1.2	Sewer Network Plan	Kernel Density Function
1.3	City Plan, Sewer Network Plan, Built Plan, Population's data for city district	Buffer, Intersect, Union, Voronoi's Poligons, Field Calculator
2.1	City Plan - Residential Development Areas	Reclassification
2.2	City Plan - Industrial Development Area	Reclassification
2.3	City Plan - Local Services Development Areas	Reclassification
3.1	Built Plan	Euclidean Distance
3.2	Sewer Network Plan, Waste Water Treatment installation position	Raster calculator, Classification, Cost Map, Cost Distance Map
3.3	Road Network Plan	Euclidean Distance
4.1	River Network Plan	Euclidean Distance
4.2	Lidar Elevation Map	Slope, Classification
4.3	Hydro-Geological Risk Plan	Classification

2.4.2 Design

The design phase consists in the standardization of the factor map representative of each node, according to a scale of values increasing and variable in the range [0;1]. The maximum value corresponds to the judgment that maximizes the achievement of the goal.

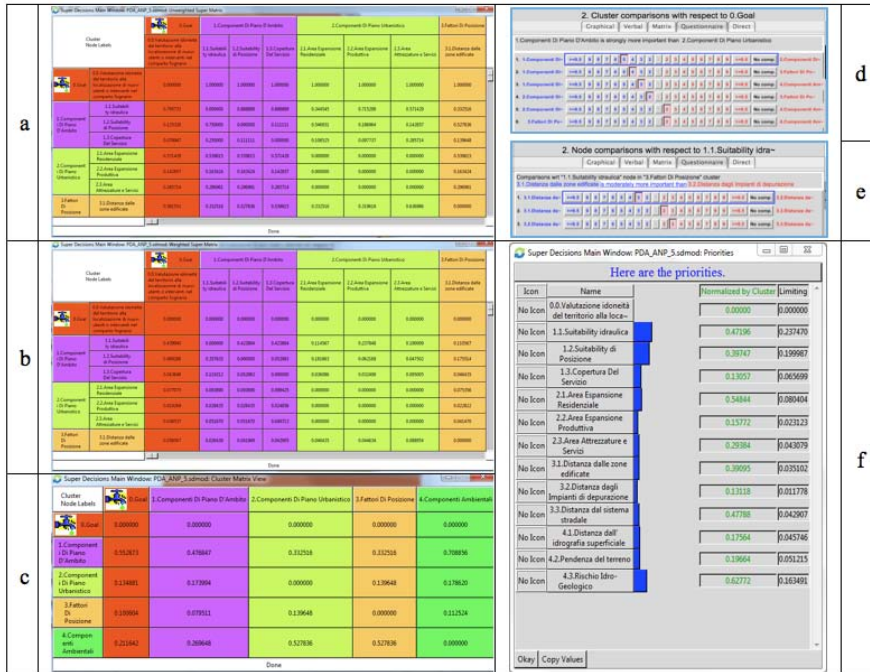

Figure 14. Superdecision Results: a) super-matrix, b) weighted super-matrix, c) clusters matrix, d) Comparison between clusters, e) Comparison between Nodes, f) Priorities

Constructed and standardized the maps we switch to the calculation of the weights through the use of the software *Superdecision 2.2.3*.

The decision network seen previously as reconstructed in the software that allow to make the comparisons in pairs, between clusters, and between nodes that are used to identify both the preferences between nodes and between clusters compared to the goal.

Made all comparisons, the software builds as first a super-matrix, which is then weighed with the preferences expressed between clusters, contained in a second matrix.

The super weighted matrix is then multiplied by itself an infinite number of times until to converge in a matrix whose columns, all the same, represent, the vector of the priority between nodes.

2.4.3 Choice

Calculated the weights from the elaboration of the ANP Model is possible to weigh and aggregate the maps, standardized earlier, for each cluster of the network using map algebra operations in GIS environment.

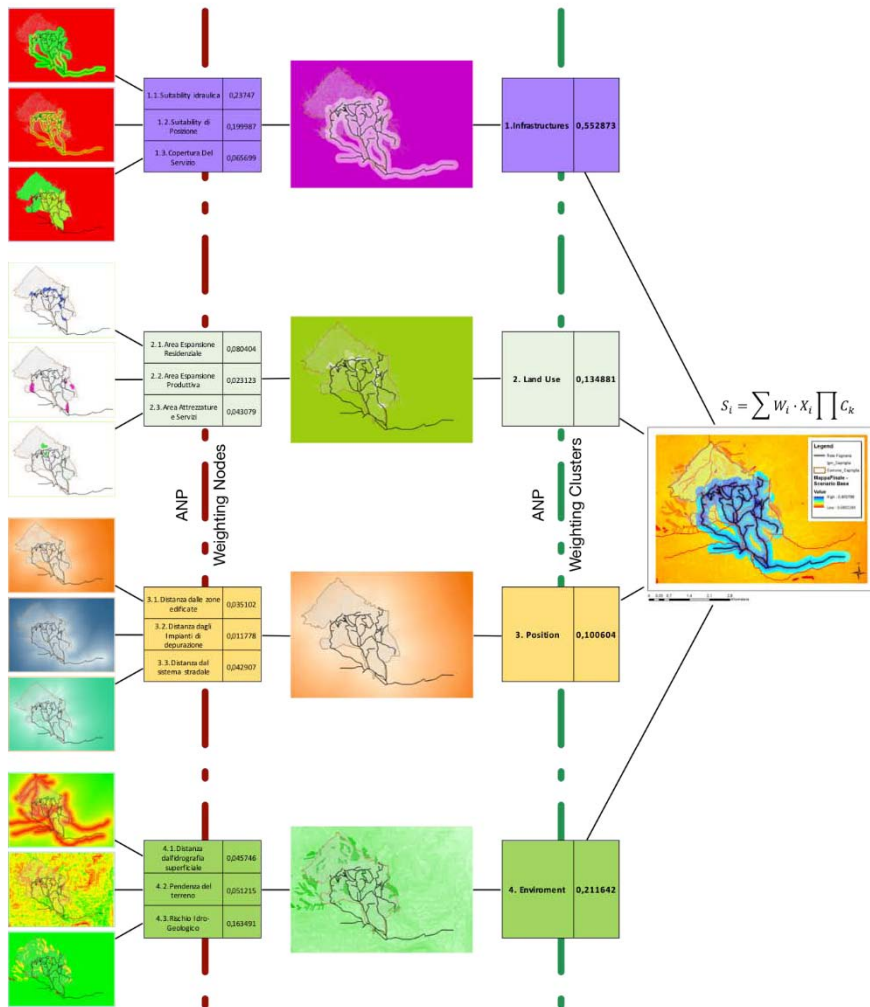

Figure 15. Assembling spatial ANP Results

From the composition of the maps represented the cluster, summed and weighed with the results of the ANP, and excluding areas under constraint, you get the map of suitability searched, indicating the areas most suitable for the location of new users or new investments in sewerage sector.

2.4.4 Review

The construction of all of the maps of suitability, from partial ones to that final overall, depends on the importance attributed to each element of the network. One of the most critical points of Multi-criteria Analysis is the time of the subjective evaluation that, even if balanced by complex

procedures of comparison of the opinions expressed, affects in any case the final result of the evaluation.

It is therefore necessary to perform a sensitivity analysis which in our case is based on the creation of different scenarios, simulating different points of view, through the variation of the weights of the criteria used in the process, in order to check the stability in the results obtained in terms of maps of suitability (Chen et al. 2010; Nekhay et al., 2009; Zucca et al., 2007; Geneletti, 2008).

In particular were defined 4 additional scenarios referred to, the first balanced because defined to equal weights, and the other obtained by varying in rotation, to greater weight, a criterion with respect to the other.

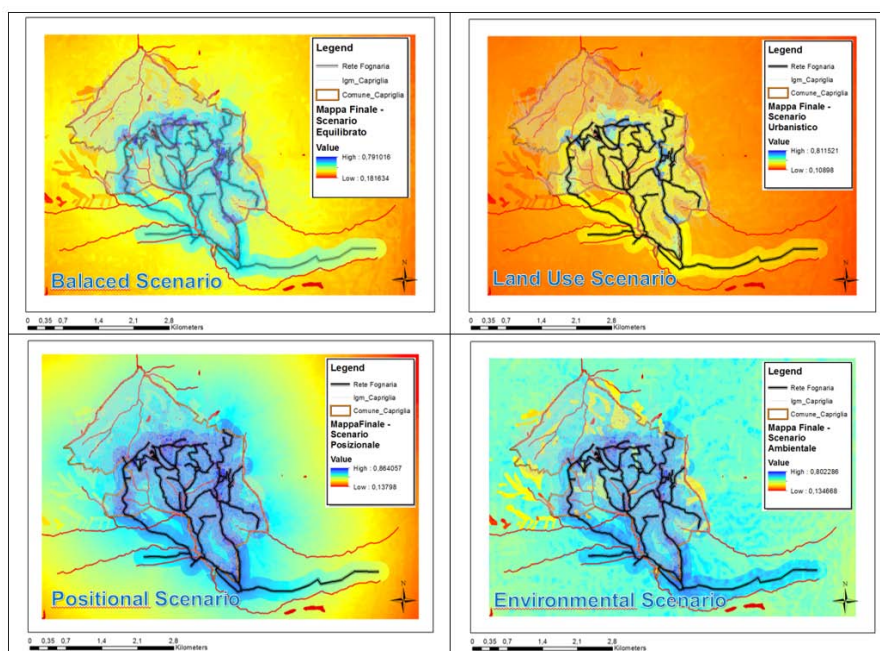
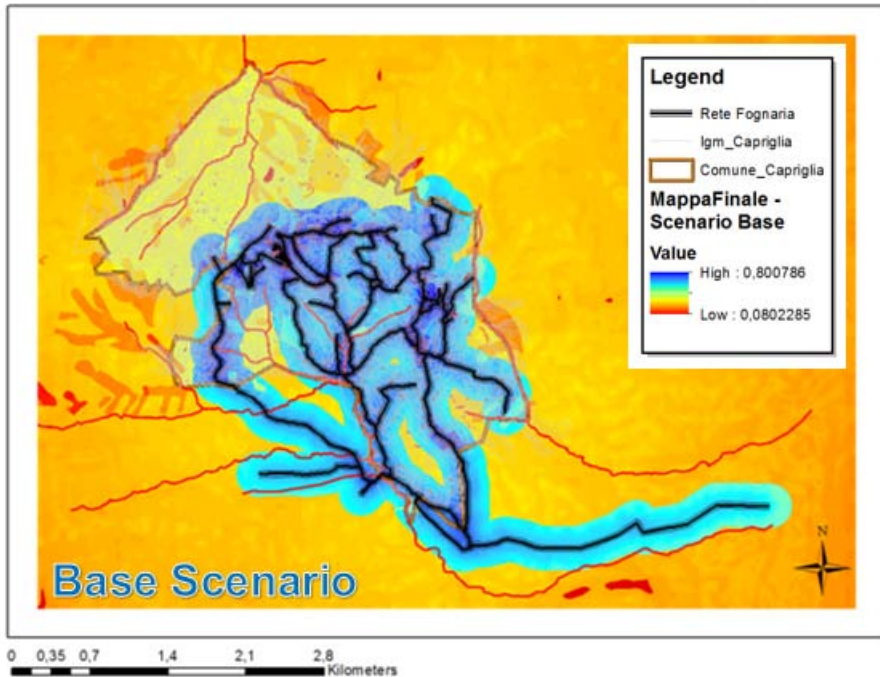

Figure 16. Sensitivity Analysis

3. RESULTS AND DISCUSSION

The valuation process, by weighing the various factors that, positively or negatively, influence the location of new utilities, or works on the network, has led to the realization of the final map of suitability, illustrated in Figure 9. The comparisons between the scenarios presented and the base-map of suitability, allows further methodological considerations on the procedure adopted.



In fact, by examining the differences between the maps of the scenarios, it is possible to find in particular the convergence, with the base-result, of the areas with greater suitability.

The application tested on the sample town has made it possible to evaluate the choices of the current City Plan instrument, in fact, from the overlay with the suitability map are following major feedback considerations feedback on the expansion areas planned by the City-Plan itself.

From the result obtained can be seen like a significant portion of the territory is unsuitable to the location of new users or works of expansion of the network, while the territories with higher values of suitability are concentrated mainly in areas already urbanized and served.

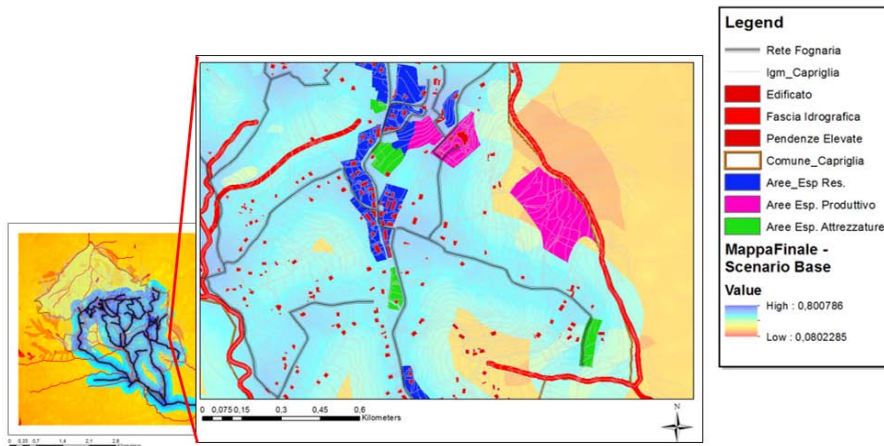

Figure 18. Comparison of Suitability Map and City Plan - Production Area located in a not optimal area.

Regarding the areas of residential expansion these fine blend into the existing urban fabric, presenting high levels of suitability with respect to which it is possible to exclude the investments for expansion of the network initially planned, in the Water Infrastructure Plan in force, needed for this additional demand.

All scenarios share the result that some areas for the expansion of productive areas activities and services areas, of the City Plan in force, are located in places with low suitability.

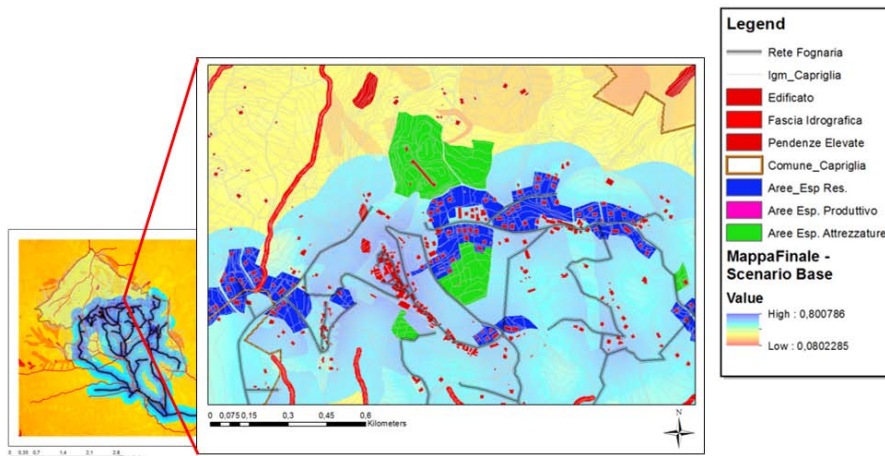

Figure 19. Comparison of Suitability Map and City Plan - Area Activities and Services located in a not optimal area.

In these areas in fact is not present sewerage and therefore these will be served with the realization of specific works for which costs will increase in inverse proportion to the suitability of the area itself.

In this case would be moved to the City Plan constructive criticism because locating these areas in such contexts has made, indirectly, high the cost of transformation of the same areas as they will be high the costs of the urbanization infrastructure related.

Data analysis then allows us to evaluate the choices made in the City Plan regarding the placement of the additional demand of services. On the one side has allowed to eliminate part of work for the expansion of the network, because part of the demand has been placed in areas already served and efficient, the other shows us how a demand spatially undefined or in wrong position will result in increasing investment costs if we get away from the concept of densification of services and built. In highly urbanized areas or sections (high Coverage of Service) and dense, the ratio representing the infrastructure endowment per capita served, has values generally low, and this means that in these areas, with a few meters of the network, it is possible to serve more people with lower cost of implementation and management. Conversely, in the areas or sections slightly urbanized and scattered, with low coverage of service, it takes many meters network to serve a few people, which results in costs of implementation and management very high. In this context, the logic of densification is the one that allows you to combine all the different aspects examined, in particular those of economy and efficiency.

The case study shows how the scope of work provided by the applicable Water Infrastructures Plan is reduced by almost 50% by calculating actual interventions on the network and even more if we consider only expansions of the network related to residential areas as well as provides the PDA.

Interesting reflections arise also from the sensitivity analysis (SA) of the results developed for the application in question; the SA allows to highlight the problematic aspects of the procedure and, at least in principle, to investigate them more thoroughly and to improve them. The spatial sensitivity analysis is, in fact, a process through which the Decision Maker reaches a deeper knowledge about the structure of the problem and a greater awareness regarding the performance of the alternatives in light of the uncertainty and the risk threshold considered acceptable (Geneletti and Abdullah, 2009). This analysis explicitly how the various decisional elements interact to choose the most valuable solution and which constitutes sources of disagreement within the process.

4. CONCLUSIONS

We cannot think of reaching a level of service equal to 100% of the entire municipality, then the need to redefine the objectives of the service, traditionally used for the design of new works, is an obvious choice.

The service's targets are redefined with respect to the space component of demand, until now neglected, and for sections or urban areas functionally linked to the directives of the City Plan. It is evident that the presence of the constraints and decision factors limits the number and the geographic extent of the space of alternatives because, by definition, they also represent the restrictions imposed to the decision space, becoming the drivers that determine precisely the set of possible alternatives.

The numbers show how dutiful a disincentive policy for investments placed outside urbanized areas which suffer of structural weaknesses.

The application of the methodology opens a series of reflections on both the techniques investigated that as regards the use of the same to achieve the goals, that is rearrangement of methodical planning in this field using the input-feedback mechanisms between the Plan and Scope and the City Plan, in a view of a smart integrated planning.

The sample application showed that the models MC-SDSS are able to offer significant support in the phase of macro-localization of the areas most suitable to accommodate new users and then to integrate them better with the system of the existing infrastructure.

With reference to the technical aspect, the application showed that the Multicriteria Spatial Analysis can provide effective support to the strategic planning phase of the investments of territorial transformation, providing a knowledge base useful for subsequent more detailed analysis (micro-location). In fact, in the light of the results obtained, many appear to be the potential of the spatial ANP approach within the definition of the investment of territorial transformation. First, the analysis has highlighted what factors are most significant for the decision through a transparent evaluation process.

The discussion highlighted the potential integration of GIS techniques and Multi Criteria Analysis, explaining how this approach is very useful in providing decision support in a systemic way, transparent and repeatable, thanks to a clear and rational presentation of the results, facilitated by the creation of thematic maps.

One of the most significant potential models MC-SDSS therefore refers to the support they provide to both in the planning phase, where they can help to generate alternative options, and in the evaluation phase, which they allow the comparison of alternatives on the basis of a variety of criteria in order to explicitly impacts, levels of trade-off and the overall attractiveness.

The application developed showed that the limits of a Multicriteria Spatial Analysis essentially make reference to the availability and accessibility of spatial data, rarely of public type and still scattered among various agencies, and also the need for preliminary processing of the data before they can be used in software MC-SDSS.

With respect to the main aspects, the application showed that the method allows to optimize the size and location of investments necessary to meet

the criteria of service, looking at the actual efficiency of the networks. In fact, comparing the results obtained with the previsions in the PDA, in relation to the sample area, there has been a contraction of the investments planned by the same PDA.

Furthermore, the suitability-map obtained allows to validate the address criteria for urban transformations that has to be followed in the municipal urban planning. In fact, comparing the map with the existing urban forecasts of the sample area it was found as the choices of development relating to the production functions of tourist type are completely contained in the worst level of suitability, and, as regards residential functions there has been a localization not optimized with respect to the location preferences of future investment on the infrastructure.

The methodological approach adopted for the phase of definition of the areas potentially suitable has provided, in fact, substantial support for further assessment. This one concretely stand for a useful knowledge base for the next phase of analysis, more detailed, for the micro-location of investments, or for the update of the City Plan. In fact, it will be possible select and compare alternatives, choices and drivers of the Plan also with regard to the infrastructure subsystem, which represents the carrier network on which should be developed all activities of land use.

Future developments of the research presented refer to the extension of the methodology to the other component of the water infrastructure, the water distribution network. Furthermore, the development of a sensitivity analysis based on the generation of multiple combinations of weights, to be associated with several criteria, in order to take due account of the uncertainty relating to them (Geneletti, 2008; Aragonès-Beltran et al., 2010), also through the approach of fuzzy logic (Zadeh, 1965).

REFERENCES

- Aragonés-Beltran P., Pastor- Ferrando J.P., Garcia F., Pascual- Agulló A. (2010), “An Analytic Network Process approach for siting a municipal solid waste plant in the Metropolitan Area of Valencia (Spain)”, *Journal of Environmental Management*, (91), 1071-1086.
- Bottero M., Ferretti V. (2011), “An Analytic Network Process (ANP) based approach for location problems: the case of a waste incinerator plant in the Province of Torino (Italy)”, *Journal of Multicriteria Decision Analysis*, 17, 63-84.
- Burrough, P. A. (1986), *Principles of Geographic Information Systems for Land Resources Assessment*, Clarendon, Oxford.
- Chen Y., Yu J., Khan S. (2010). “Spatial sensitivity analysis of multi-criteria weights in GIS-based land suitability evaluation”, *Environmental Modelling and Software*, 25 (12),1582-1591.
- Figueira J., Greco S., Ehrgott M. (2005), *Multiple criteria decision analysis.State of the art surveys*, Springer, New York.
- Geneletti D., Abdullah A. (2009), *Spatial decision support for urban and environmental planning. A collection of case studies*, Academic Press, Kuala Lumpur.

- Geneletti D. (2008), "Impact assessment of proposed ski areas: A GIS approach integrating biological, physical and landscape indicators", *Environmental Impact Assessment Review*, 28(2), 116-130.
- Goodchild, Michael F., Bradley O. Parks and Louis T. Steyaert (1993), *Environmental Modeling with GIS*, Oxford University Press, Oxford.
- Malczewski J. (1996), "A GIS Based Approach to Multiple Criteria Group Decision Making", *International Journal of Geographical Information Systems*, 10, 995-971.
- Malczewski, J., 2006a. "GIS-based multicriteria decision analysis: a survey of the literature", *International Journal of Geographic Information Systems/Science*. 20(7), 703-726.
- Navigant research (2011), Global Investment in Smart City Technology Infrastructure to Total \$108 Billion by 2020 (available <http://www.navigantresearch.com/newsroom/global-investment-in-smart-city-technology-infrastructure-to-total-108-billion-by-2020>. access on 05.04.2015)
- Nekhay O., Arriaza M., Boerboom L. (2009), "Evaluation of soil erosion risk using Analytic Network Process and GIS: A case study from Spanish mountain olive plantations", *Journal of Environmental Management*, 90, 3091-3104.
- Roscelli R. (2005), *Misurare nell'incertezza*, Celid, Torino.
- Saaty R. W. (2003), *Decision making in complex environments: The Analytic Hierarchy Process (AHP) for decision making and the Analytic Network Process (ANP) for Decision Making with Dependence and Feedback*, RWS Publications, Pittsburgh.
- Saaty T. L., Vargas L. G. (2006), *Decision Making with the Analytic Network Process*, Springer Science, New York.
- Saaty T.L., Ozdemir M.S. (2008), *The Encyclicon. A Dictionary of Complex Decisions Using the Analytic Network Process*, RWS Publications, Pittsburgh.
- Sharifi, M. A., & Rodriguez, E. (2002), "Design and development of a planning support system for policy formulation in water resources rehabilitation: The case of Alca'zar De San Juan District in the Aquifer La Mancha Spain", *International Journal of Hydroinformatics*, 4(3), 157-175.
- United Nations Educational, Scientific and Cultural Organization (2015) *Water for a sustainable world*, The United Nations World Water Development Report, United Nations World Water Assessment Programme, Paris.
- Utilitatis (2014), *E-BlueBook 2014*, Utilitatis, Roma.
- Worrall, Lew (1991). *Spatial Analysis and Spatial Policy Using Geographic Information Systems*, Bellhaven Press, London.
- Yüksel, İ., & Dağdeviren, M. (2007), "Using the analytic network process (ANP) in a SWOT analysis. A case study for a textile firm", *Information Sciences*, 177, 3364-3382.
- Zadeh L.A. (1965) "Fuzzy sets", *Information and Control*, 8, 338-353.
- Zucca A., Sharifi A., Fabbri A. (2007), "Application of spatial multi criteria analysis to site selection for a local park: a case study in the Bergamo Province, Italy", *Journal of Environmental Management*, 88, 752-769.

NO.92

The Effect of Star School Districts on Residential Property Prices in the Chinese Context

Linchuan Yang^{1*}, Ziwei Ye², Yunyi Zhang², Bo Wang³, Yuzhuo Wang⁴ and Geng Cheng⁵

1 Faculty of Engineering, the University of Hong Kong

2 Department of Urban Planning, Xiamen University

3 Department of Geography, the University of Hong Kong

4 School of Architecture, Southeast University

5 Hong Kong Urban Planning Institute

** Corresponding Author, Email: yanglc0125@gmail.com*

Key words: Hedonic Price Model, Star School Districts, Residential Property Prices, Xiamen Island, GIS

Abstract: Like many Chinese cities, the enrolment of elementary school in Xiamen Island is based on school district demarcation. Due to the scarcity of star schools, household registration system and school district demarcation, a feasible approach for parents to provide good education to children is to purchase a house in a star school district. Supply-demand imbalance gives rise to the "soaring housing prices in star school districts" (*xuequ fang*) phenomenon. Based on 1250 housing samples in 286 multi- or high-storey residential districts, this paper develops a hedonic price model to empirically estimate the magnitude of the relationship between star school district and residential property prices. Our results shed light on substantial capitalization benefits of star school districts on housing values: houses located within the star school district exhibited 9.4% higher values than those located outside of the area. Its negative influences and several countermeasures are also discussed.

1. INTRODUCTION

Education is the foundation of a nation, and is closely related to the quality of the nationals as well as the long-term development of the nation. There have been well-known educational sayings like "Education is life; Education is growth; Education is the transformation of experience" (Dewey), "Education is training carried out for later life, which can make people benevolent, hence their noble act" (Plato), "Education is freedom" (Kant). The importance of education to the individual, the state and the

society is thereby revealed profoundly. Specifically, in China, the entrenched thought of "expecting the kids to be successful(*wang zi cheng long*)" places education on a more crucial position in the minds of parents.

Some schools are considered as star schools, specifically due to higher rate of students' entering schools(*sheng xue lv*) or test scores, better educational assessment/outcomes or teachers, more complete supporting facilities, etc. However, high-quality education resources are unevenly distributed in the space due to the scarcity.

Housing is a multi-dimensional property, characterized by durability and structural inflexibility as well as spatial fixity. Apart from this, housing is a heterogeneous commodity distinguished by several characteristics, which exercise an influence on its price(So et al., (1997)). Hedonic price model (HPM) is a common empirical tool to assess, appraise and estimate the determinant factors on the prices of heterogeneous goods such as residential real estate(Malpezzi, (2003)). Recently, the rapid development of geographic information systems (GIS) has made HPM more powerful because "spatial statistics within a GIS, based on digitized remote sensing data, have made possible the development of accurate, consistent, and unbiased explanatory variables...in a fast and efficient manner" (Kong et al., (2007)). With the help of GIS, several attributes of properties can be measured precisely, making the developing of HPM more easily and conveniently, increasing our understanding of the variations of residential property prices as a result.

High-quality education resources always have an important positive impact on residential property prices(Black, (1999)) because most of parents tend to live in the communities near to star schools for giving better education to the children. As a result, they are willing to pay higher prices for dwelling units near to star schools, a portion of which is parents' investment in children's future. The externality of star schools has been found to be capitalized in housing prices(Black, (1999); Clapp et al., (2007)).

Actually, school quality has been long perceived as a crucial determinant on the prices of residential real estate. In the western context, there is a wide range of pioneering literatures concerned with its capitalization benefits. Using home purchases and historical data on homes, (Hayes and Taylor, (1996)) validated that the neighborhood school was an important locational attribute in determining residential property prices as commonly suggested by popular wisdom and economic research. Also, they found the relationship between test scores and property prices was related to the underlying relationship between property values and the schools' marginal effects (rather than school expenditures or student body characteristics). Black argued that estimates without control for neighborhood attributes sufficiently might overstate its influence because better schools tended to be located in better neighborhoods. Consequently,

he proposed boundary fixed effect method, compared prices of housing located on opposite sides of attendance district geographic boundaries in Massachusetts, and founded the capitalization of parents' willingness to pay more for better schools in housing prices(Black, (1999)). Conducted in Howard County, USA, (Sedgley et al., (2008)) applied educational assessment and outcomes to measure school quality, proceeded with hedonic analysis, presented the consistent and strong evidence of the capitalization of test scores on residential property prices, and demonstrated that housing within good school districts was more expensive than housing not situated in the area. Using panel data of housing transactions in the state of Connecticut spanning eleven years, (Clapp et al., (2007)) ascertained the relationship between property values and school district attributes, and confirmed Black's finding(Black, (1999)) that failing to control for unobservable components of neighborhood quality would result in an overestimate of the effect of test scores on residential property values.

In China, along with increasingly fierce social competition, education has become an important way to enhance a person's competitiveness. Parents pay increasing attention to the children's education, and invest more and more in education consequently(Kong, (2003)). Today, in China, family investment in education shows a new feature : buying housing located in star school districts. The modern version of "Moving three evictions , optional neighbouring states (meng mu san qian, ze lin er ju)" has been witnessed frequently: in order to give children access to high-quality education facilities, parents strive to be the first to pay higher prices to purchase a house located in a star school district. Housing values are pushed up. The "soaring housing prices in star school districts" (xue qu fang) phenomenon has become a focus of the society(people.cn, (2015)).

Actually, the admission policy of elementary school in China may be different from that in other countries. In several Chinese cities, every public elementary school enrolls students based on school district demarcation. In other words, restricted by household registration, only the children of the owner (rather than renters) of houses located in X elementary school districts are entitled to enroll in X school. Fettered by the school district, elementary-school-age children cannot freely attend the primary schools in the light of their parents' willingness. Therefore, a viable approach for parents to provide superior education to their children is to purchase a house in a star school district. Not surprisingly, housing prices tend to be higher in star school districts.

In the Chinese context, most pertinent literatures concentrated on discussing and analyzing "soaring housing prices in star school districts" phenomenon from the perspective of sociology, pedagogy or economics(Chen and Tang, (2009); Wu, (2006); Zhang, (2011)). Not much research attention to date has been paid to empirically estimate the

magnitude of the relationship between housing prices and star school district in China. Existing researches focusing on measuring its extent were limited in a small number of cities: Beijing(Hu et al., (2014); Huang, (2010)), Shanghai(Feng and Lu, (2010); Shi and Wang, (2014)), Nanjing(Wang et al., (2010)), Tianjin(Wang et al., (2014a); Wang et al., (2014b)), Chengdu(Meng, (2013)), Baoding(Nie, (2011)). However, some of them have more or less drawbacks, denting the accuracy and credibility: for example, unsatisfactory explanatory power(low goodness-of-fit)(Nie, (2011); Wang et al., (2014a); Wang et al., (2010)), inadequate control variables(Meng, (2013); Wang et al., (2014a)), small sample size(Wang et al., (2014a)).

Compared to earlier studies on this topic, three newer ones- (Shi and Wang, (2014)), (Hu et al., (2014)) and (Wang et al., (2014b))- may be more reliable and satisfactory. Using data from a commercial housing website(soufang)(N=1172), (Shi and Wang, (2014)) discussed the impacting mechanism of housing prices of school districts in Shanghai based on a HPM, found that school factors accounted for 20.6% of the difference in residential property prices, concluded that housing prices declined by 8.7% with a drop in the level of school grade. Conducted in Beijing, (Hu et al., (2014)) applied the boundary fixed effect method as noted in (Black, (1999)) to sufficiently control for neighborhood attributes, used matching regression techniques to mitigate the omitted variable bias caused by unobservable neighborhood attributes, and found that the prices of housing located in key primary school districts are 8.1% higher. (Wang et al., (2014b)) used HPM to analyze the capitalization of basic educational resources based on the second-hand housing data(N=1700) in Heping District, Tianjin, reported that an increase of elementary school quality would lead to housing prices increasing by 14.7%.

This paper is organized as follows: in Section 2, the basic methodology-HPM is described in detail, including theoretical foundations, variable choice, function forms; Section 3 introduces the study area and data; Section 4 presents HPM results; Section 5 discusses school district demarcation and its negative influences and proposes some tentative countermeasures while some conclusions and further research directions are drawn in Section 6.

The main contributions of this study were twofold: (1) filling the research gap, adding an reliable empirical study in the Chinese context about quantitative valuation of star school districts to the existing relatively limited literatures; (2) shedding additional light on the mechanism of “soaring housing prices in star school districts” phenomenon and proposing some countermeasures.

2. ANALYTICAL FRAMEWORK

From the perspective of studying the demand side of goods, HPM is a celebrated and widely accepted model for calculating the implicit prices of housing attributes. Hedonic prices are the implicit values of the attributes of a product, which can be empirically estimated from a multiple regression equation.

Based on the assumption that in equilibrium, all consumers with identical preference can achieve the same level of utility (which could be measured as the price a person is willing to pay for the fulfilment or satisfaction of his desire), HPM has two solid theoretical foundations. The first one is Lancaster's heterogeneous consumer theory (Lancaster, (1966)). Lancaster stated that the land-rent theory, a classic urban economic theory proposed by Alonso in 1964 (Alonso, (1964)), could only explain some variations in residential property values, but it was not insufficient to explain the total difference in property values due to the ignorance of inherent attributes a property contains. Therefore, he defined utility in terms of the attributes of the goods, and argued that what consumers are seeking to acquire is the characteristics embodied in the goods instead of goods themselves. In other words, a property is sold as a package of inherent attributes. The second one is Rosen's hedonic market theory (Rosen, (1974)). It presents that under the conditions of fully market competition, the objectives of producers and consumers are profit maximization and utility maximization respectively, and unfolds how markets work for heterogeneous goods.

Typically, HPM applies multiple regression techniques to relate property price details to diverse characteristics of different goods. The simpler functional form of HPM is the linear model. It is as follows:

$$P = f(X_1, X_2, \dots, X_n) + \varepsilon = b + a_1X_1 + a_2X_2 + a_3X_3 + \dots + a_nX_n + \varepsilon$$

where P is the housing price; X_1, X_2, \dots, X_n are the characteristics embodied in the property; ε is random error term that reflects the unobserved variations in property prices; a_1, a_2, \dots, a_n are the regression coefficients; b is a constant. Apart from linear form, HPM has other basic functional forms: (1). Semi-log linear model: $\ln P = b + a_1X_1 + a_2X_2 + a_3X_3 + \dots + a_nX_n + \varepsilon$, where dependent variables are in natural logarithms. (2). Double-log linear model: $\ln P = b + a_1 \ln X_1 + a_2 \ln X_2 + a_3 \ln X_3 + \dots + a_n \ln X_n + \varepsilon$, where both independent and dependent variables are in natural logarithms. HPM also have some flexible functional forms, such as trans-log form, semi-log quadratic form. In some literatures, the Box-Cox transformation is used to choose among alternative functional forms of HPM in order to obtain a better model specification. The core philosophy of Box-Cox transformation is "let the data speak".

Normally, the hedonic variables putting into HPM can be categorized into three broad groups: structural, location and neighborhood. Structural

variables relate to the direct attributes of the housing, for example, floor area, age and number of bathrooms and bedrooms. Location variables reflect the ease with which amenities can be reached from the housing, such as distance to city center, shopping centers, and hospitals. Neighborhood variables describe the quality of its surroundings, such as income and education level of residential districts, proximity to star school, crime rates.

HPM is capable of explaining housing prices in terms of its own characteristics, which are assumed to be implicitly priced. It has been widely used to estimate the implicit values of a wide variety of attributes of differing properties, and evaluate the contributions of different factors on housing prices, for instance, educational facilities(Sedgley et al., (2008)), shopping centers(Des Rosiers et al., (1996); Tse and Love, (2000)), hospitals(Peng et al., (2014)), public transport(Armstrong and Rodriguez, (2006); Cervero and Duncan, (2002); Yang et al., (2015)), green space(Acharya and Bennett, (2001); Kong et al., (2007); Luttik, (2000)), population density(Geoghegan, (2002)).

3. STUDY AREA AND DATA

3.1 Study area

In order to fill the gap by developing and performing a HPM to estimate the benefits deriving from star school district in the Chinese context, our study area is Xiamen Island, the central city of Xiamen. Xiamen is known as Amoy historically, located on the southeast coast of China with a total administrative area of 1573.16 km² and a permanent population of 3.73 million in 2013(Xiamen Statistics Bureau, (2014)). It was designated as one of the earliest four Special Economic Districts in October, 1980 and granted sub-provincial administrative status by the Central Government of China on February 25, 1994.

Xiamen Island is the earliest developed area of Xiamen, and still remains the central city of Xiamen now. It is made up of Siming District and Huli District, owning a total of 131 km² land. The Jinmen Islands are less than 10 kilometres away. A significant feature differentiating Xiamen's city profile from the others is its unique status being located on the west coast of Taiwan Strait.

The reasons to choose Xiamen Island as our study area are as follows: Firstly, traditional HPM cannot handle omitted variable bias. One of effective methods to circumvent this problem is to focus on narrow geographic areas where many influences can be properly controlled (Brasington, (2003)). The scale and geographical features of Xiamen Island makes it a tractable and ideal region to conduct this research for reasons of

comparability because the variations in many aspects are easier to be removed or controlled effectively. Secondly, like several Chinese cities, public elementary schools in Xiamen Island enroll students based on their school district demarcation. Last, in 2013, GDP per person of Xiamen is 81.6 thousand yuan(RMB) (Xiamen Statistics Bureau, (2014)), which is more than that of most of Chinese cities. The living of residents in Xiamen Island is at the higher economic level, far exceeding the subsistence level. There may be more disposable income spent in other fields such as housing.

3.2 Data

There are hardly any new-built residential districts in the highly-developed Xiamen Island now. Therefore, our research focuses on normal second-hand commercial housing for reasons of comparability, not considering terraced house, villa, removal settlement building and affordable housing.

Data for this analysis come from two sources. The data set of housing samples (N=1250) are obtained from the original researchers in (Yang et al., (2015)), which was collected from a famous Chinese commercial housing website named soufang (<http://xm.fang.com/>) on April, 2014. Collecting the data in such a short period of time can effectively avoid short-term fluctuations of housing prices, increasing the accuracy of this research. Refer to (Yang et al., (2015)) for further information.

Apart from collecting housing samples, creating a workable GIS database is also particularly essential. We used the data from the government website or Baidu Map (a publicly available website) to establish the GIS database of Xiamen Island. These independent variables(X4-X12) are all quantified within the framework of GIS.

As illustrated in Fig.1, the sampled residential districts were geographically spread throughout Xiamen Island, with 452 samples from 106 residential communities in Siming District and 798 samples from 180 residential communities in Huli District.

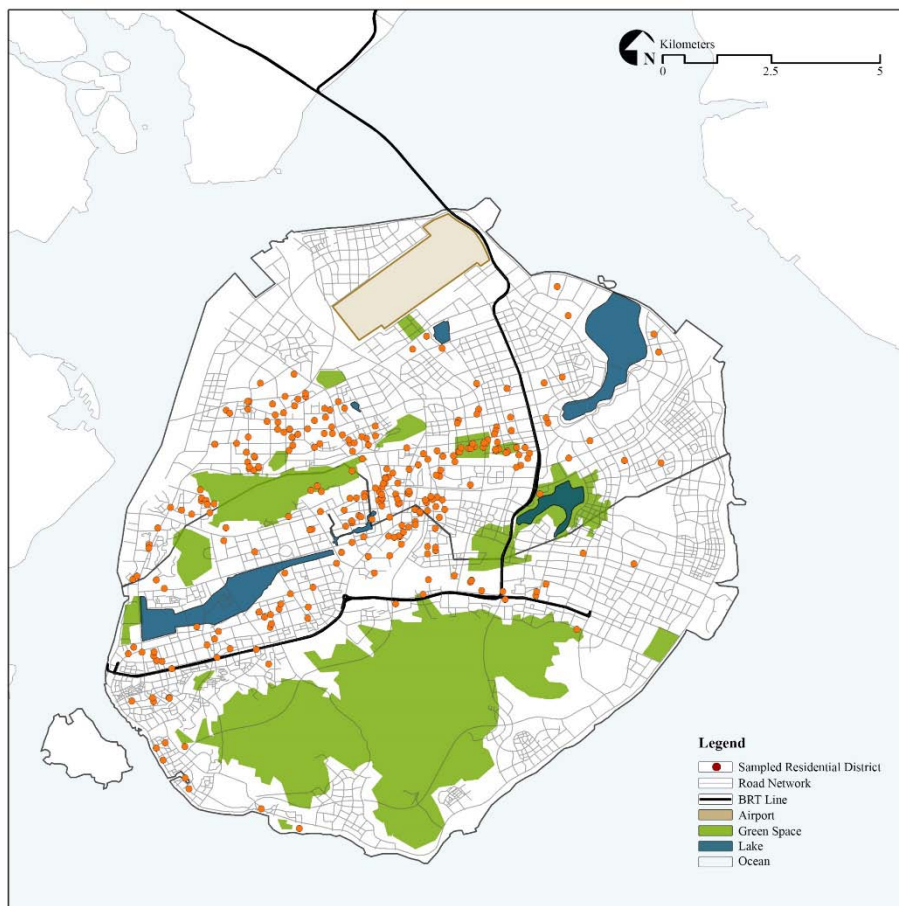

Figure 20. the study area and spatial distribution of sampled residential districts

How to measure star schools? Western researchers often use students' test scores or pass rate of on the specific exam(s), school expenditures and earnings, student-teacher ratios to differentiate star schools from normal ones, actually with differing judging criterion. In China, identifying star school may be substantially simpler. It is widely accepted that provincial-level demonstration elementary schools granted by education department (jiao yu ting) of the provincial government are star schools. In our research, star schools refer to provincial-level demonstration elementary schools.

Now, there are eight provincial-level demonstration elementary schools in Xiamen Island(Fig.2), involving Yanwu Elementary School, Minli Elementary School, Experimental Elementary School, second Experimental Elementary School, Datong Elementary School, Affiliated elementary school of Foreign Language School, Bindong Elementary School and Binlang Elementary School. It is noteworthy that all of them are situated in the west of Siming district, revealing apparent spatial variation and imbalance.

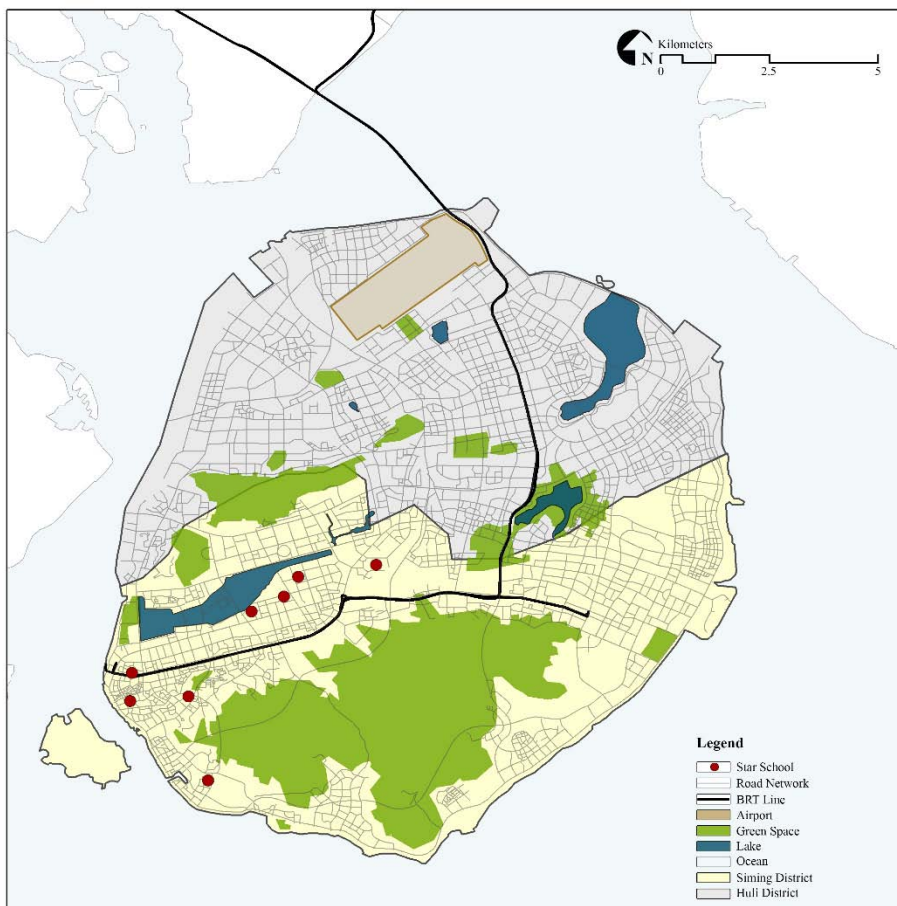

Figure 2. star schools in Xiamen Island

3.3 Variables

Based on our research goal, reality of Xiamen Island, data availability and previous literatures, 12 independent variables are selected in our study. As shown in *Table 1*, X_1 and X_2 capture structural attributes, $X_3 - X_8$ describe neighborhood characteristics while $X_9 - X_{12}$ represent location variables. All independent variables but X_4 are theoretically important variables that we need to statistically control for by including them in the model. It should be noted that two widely-used variables, number of bedrooms(*shi*), number of halls(*ting*), were not included in our analysis because as (So et al., (1997)) stated, their effects would have overlapped with Gross floor area, resulting in the presence of multicollinearity.

Table 1. Variable descriptions and Descriptive Statistics (N = 1,250).

Short	Independent variable	Description	Expected sign ¹
X ₁	Area	Gross floor area(m ²)	+
X ₂	Age	2015 minus occupation permit year (number of years)	-
X ₃	Residential district environment	Internal environment of residential districts is measured on a 5-point Likert item from “very bad” to “very good”	+
X ₄	Star school district	1 if it is in the star school district, 0 otherwise.(dummy variable)	+
X ₅	Kindergarten	1 if there are one or more kindergartens within 500 meters, 0 otherwise(dummy variable)	+
X ₆	Middle school	1 if there are one or more middle schools within 1000 meters, 0 otherwise(dummy variable)	+
X ₇	Xiamen University	1 if Xiamen University is within 1000 meters, 0 otherwise(dummy variable)	+
X ₈	BRT(Bus Rapid Transit)	1 if there are one or more BRT stations within 800 meters, 0 otherwise(dummy variable)	+
X ₉	Distance to hospital	Euclidean distance to the nearest Class 2A or 3A hospital (km)	?
X ₁₀	Distance to cultural/sports center	Euclidean distance to the nearest cultural/sports center (km)	-
X ₁₁	Distance to business center	Euclidean distance to Zhongshan Road, city center of Xiamen Island(km)	-
X ₁₂	Distance to lake	Euclidean distance to the nearest lake(km)	-

¹ + and – represent increasing and decreasing impacts on the housing prices respectively; ? indicates a priori undetermined sign.

3.4 Functional form choice

Functional form choice is an important issue. Linear model is the simplest model specification and the coefficients of independent variables are simply marginal changes, or prices per unit of characteristics, which are easiest to interpret compared with other functional forms. However, as (Rosen, (1974)) states, there is no reason to assume that the relationship between the price and environmental variable are linear. An apparent shortcoming of linear model is that it cannot reflect diminishing marginal utility. What’s more, linear model imposes independence on the chosen explanatory variables(Halstead et al., (1997)). To the best of our knowledge, it has been formulated less and less in literatures published in recent years.

Semi- and double-log model specifications are frequently used. Apart from these basic forms, Box–Cox flexible functional form was used in some existing literatures (Goodman, (1978); Halstead et al., (1997); So et al., (1997)), because it can obtain the “best fitting” model with highest

goodness-of-fit. Nevertheless, applying “good fit” criterion to select functional forms does not always lead to more accurate estimates of characteristic prices(Cassel and Mendelsohn, (1985)). In other words, choosing a functional form just on the basis of crude goodness of fit measures may not be appropriate. As (Ben-Akiva and Lerman, (1985)) pointed out, “a ‘good fit’ to data does not necessarily mean an adequate model, and it is not unusual to find several alternative model specifications that fit the data equally well. Moreover, a model can duplicate the data perfectly but give erroneous predictions”. Even, Greene reported that allowing the transformation parameters to differ for the dependent and independent variables is “usually taken to be more cumbersome than necessary”(Greene, (1993)).

Therefore, this study uses a commonly employed functional form, semi-log linear model. The dependent variable is modified by a natural log transformation of the housing prices. It is as follows:

$$\ln P = f(X_1, X_2, \dots, X_{11}, X_{12}) = b + a_1 X_1 + a_2 X_2 + a_3 X_3 + \dots + a_{12} X_{12} + \varepsilon$$

4. EMPIRICAL FINDINGS

Use OLS (ordinary least squares) linear regression in SPSS 17.0 to build a semi-log linear HPM. The selection method used is “Enter” with the following output as seen in *Table.2*. Overall model fit is adequate(adjusted $R^2=0.800$), but the sig. of X_5 and X_6 is over 0.05, indicating that their coefficients were not statistically different from zero at the 5% level. Hence, eliminate two statistically insignificant variables (X_5 and X_6) and build a new HPM.

Table 2: Regression results of semi-log linear model ($R^2=0.801$, adjusted $R^2=0.800$)

	Unstandardized coefficient		Standardized coefficient	t statistic	Sig.	VIF
	B	Std Error	Beta			
(constant)	4.579	.052		88.671	.000	
X_1	.010	.000	.794	59.156	.000	1.123
X_2	-.011	.001	-.106	-7.649	.000	1.202
X_3	.068	.008	.129	8.357	.000	1.484
X_4	.089	.022	.058	3.990	.000	1.306
X_5	.009	.019	.006	.467	.641	1.189
X_6	-.001	.019	-.001	-.057	.955	1.229
X_7	.206	.060	.053	3.446	.001	1.447
X_8	.077	.016	.063	4.717	.000	1.095

X ₉	.047	.011	.069	4.414	.000	1.543
X ₁₀	-.057	.011	-.074	-5.037	.000	1.347
X ₁₁	-.021	.003	-.102	-6.036	.000	1.794
X ₁₂	-0.072	0.012	-0.095	-6.055	.000	1.546

Regression results of the new model are shown in *Table 3* and *4*. As illustrated in *Table 3*, sig. value of this HPM is less than 0.001, so our model is statistically significant. The explanatory power is 80.0% of the variation in housing prices. Our goodness-of-fit value is higher than that based on the same sample set(78.9%) in (Yang et al., (2015)).

As presented in *Table 4*, sig. values of all independent variables are less than 0.005, exhibiting all of them statistically significant. Variance Inflation Factor (VIF) are very small (1.1-1.8), avoiding the presence of multicollinearity between these factors. With no exception, the signs of all variables' coefficients agree with *priori* expectations. The coefficients of X₁, X₃, X₄, X₇, X₈ are positive. Therefore, as commonly expected, houses with larger gross floor area, having better internal residential district environment and BRT access, within star school district, and being near to Xiamen University exhibit higher values.

The coefficient of X₉ is also positive, indicating that Class 2A and 3A hospital has negative effects on housing prices in Xiamen Island. It may seem somewhat surprising, but consistent with the research results in (Li et al., (2013); Peng et al., (2014)). A possible explanation is that different age groups may have varying needs of health care services. Normally, the young seldom go to the hospital. Therefore, they might not take proximity to hospital into consideration when choosing residence location, even tend to live far away from hospital. Meanwhile, the elderly tend to live close to hospital because they might go to the hospital frequently due to poor health or a decline in physical condition(Li et al., (2013)). Another probable explanation is that it is always crowded around the class 2A or 3A hospitals. People and vehicles moving frequently, bring noises and air pollution, ruining the quality of life of its nearby residents(Peng et al., (2014)). The coefficients of others have the hypothesized negative signs. It indicates that houses at younger age, with better accessibility to the business center, culture/sports center and lake, turn out to be more expensive. And proximity to normal kindergartens and middle schools do not contribute to explain price differences.

Table 3: ANOVA (Analysis of Variance) of semi-log linear model after omitting insignificant variables

	Sum of Squares	df	Mean square	F	Sig.
regression	265.381	10	26.538	500.093	.000
residual	65.749	1239	.053		
total	331.130	1249			

Table 4: Regression results of semi-log linear model after omitting insignificant variables (R²=0.801 , adjusted R²=0.800)

	Unstandardized coefficient		Standardized coefficient	t statistic	Sig.	VIF
	B	Std Error	Beta			
(constant)	4.587	.042		108.547	.000	
X ₁	.010	.000	.794	59.222	.000	1.121
X ₂	-.011	.001	-.106	-7.663	.000	1.202
X ₃	.067	.008	.129	8.350	.000	1.480
X₄	.090	.022	.058	4.052	.000	1.294
X ₇	.202	.059	.052	3.417	.001	1.423
X ₈	.077	.016	.063	4.746	.000	1.090
X ₉	.045	.010	.068	4.483	.000	1.420
X ₁₀	-.058	.011	-.075	-5.363	.000	1.216
X ₁₁	-.020	.003	-.102	-6.024	.000	1.775
X ₁₂	-0.071	0.011	-.095	-6.205	.000	1.461

By comparing the absolute values of standardized coefficients, some interesting findings are derived: (1). Gross floor area is the dominating elemental attribute, having the greatest influences on housing prices as hypothesized, followed by internal environment of residential districts and house age. Its parameter is 0.010, which means that an increase of 1 m² in gross floor area would increase the value by 1% (=e^{0.010}-1). (2). Being in star school districts has nearly the same impact on housing prices as having local accessibility to BRT. (3) Among four location variables, proximity to city center (Zhongshan Road) exhibits the largest impact on housing prices, which is consistent with Alonso’s land-rent(bid rent) theory-the most accessible land, generally in the center, is the most expensive land(Alonso, (1964)).

The parameter of star school district(X₄) indicates that located within the star school districts exhibited 9.4% (=e^{0.090}-1) higher values than that located outside of the area. The magnitude of its impact on residential property prices is nearly the same as that in Shanghai(8.7%, 9.7%) found in(Shi and Wang, (2014)) and (Peng et al., (2014)) respectively, but higher

than that in Beijing(8.1%)(Hu et al., (2014)), lower than that in Tianjin (14.7%)(Wang et al., (2014b)).

5. DISCUSSIONS

According to theories of pedagogy (Teaching and Research Section of the Department of Education in Central China Normal University, (1962)), there're four factors that affect people's physical and mental development, namely genetics, environment, schools and subjective initiative. Among them, only environment and schools are space-relevant. The former involves loads of factors, with family environment accounting for a major proportion. Hence, the latter is a very essential factor for house buyers in order to provide great positive effects for their children's physical and mental development.

The demarcation of school districts are, normally, based on elementary schools' spatial distribution, population distribution, natural boundary and so on. It is, originally, to ensure accessibility and security of school-age children. However, since elementary schools show exceptional heterogeneity, obvious disparities, tremendous diversity in some aspects such as test performance and rate of entering schools, the reality may deviate from the parents' expectations in the respect of elementary schools their children will attend. That is, assume that children living in A school districts may be expected to attend B school. Nevertheless, it may be impossible under the framework of the current regulations and policy system. So, parents have to consider buying a house in B school district so that their children can study in their ideal school. As a result, the imbalance of inadequate supply and growing demand brings increasing prices of housing in star school districts, eventually triggering the "soaring housing prices in star school districts" phenomenon, contrary to the original goals of school districts demarcation.

M. Friedman holds a view that the price is inhuman and decides who will finally get products. The originally-high housing prices may keep elevating in a period of time under the price competition if there cannot reach the balance between supply and demand. Such competition in prices may lead to a series of negative effects(Chen and Tang, (2009)): (1) unfair education resource allocation. As the nation advances, education is no longer regarded as privilege, and good education resources are expected to be unfairly allocated driven by the price-and-market mechanism. The "school district" policy makes (education) resources distribution link up with housing. In a result, the better the education resources are, the higher housing values will be. It turns out that the rich can still obtain high-quality education resources with their economic advantages, while the poor may have nearly no chance to get access to a good one. (2) forming spatial

barriers and separating different income groups. The school districts demarcation and the dramatic housing price gap have gradually exerted influence on urban form and caused the isolation of communities. Like some invisible barriers, the poor quarter and the wealthy neighborhood may be imperceptibly partitioned by different school districts with different quality of education resources. It may hamper the communication and interaction among different income groups, affect social harmony and stability, and result in the Matthew Effect of the rich and poor. (3) extruding consumer market. When people have stable disposable income but spent most on star-school-district house, it will decrease the expenses in other areas, such as food, clothes, tour, etc. This may affect the development of other industries and consumer market. Specially, with family wealth rising and living conditions improving constantly, people hold higher requirement to living space and housing. However, real estate market grows in an unhealthy way due to “soaring housing prices in star school districts” phenomenon.

Based on the aforementioned analysis, some countermeasures can be discussed:(1) reforming household registration system(HRS) gradually. Although HRS in China has its profound historical contributions, it is closely associated with the discriminative distribution of social welfare (including education). Its potential reform has drawn extensive attention of scholars and policy makers(Peng et al., (2009); Zhao, (2003)), which should not be achieved overnight, but should propel in a gradual way(Zhao, (2003)). Directly deregulating or eliminating population flowage’s limitation may not be appropriate. Instead, a transition from (discriminative) status-checking system to fundamental management system is necessary. Linking social welfare to common citizenship instead of discriminative household registration may be more favorable(Peng et al., (2009)). (2) balancing the education quality by the distribution of resources. The scarcity and unequal distribution of good education resources give rise to the “soaring housing prices in star school districts” phenomenon, constituting the biggest hinderance in the development of education. With people rushing to purchase a star-school-district house to preoccupy deficient resources , education and real estate industry grow abnormally. Accordingly, homogenizing education resources and flattening the school gap becomes imperative. To achieve educational equity and balance resource allocation, boosting education investment appropriately is essential and feasible, since it helps optimize facilities, improves teaching environment, etc. (3) highlighting family education and children’s all-round development. Obviously, not all excellent students graduated from star primary schools. School is only one external factor that shapes children. The internal factors, household education and success consciousness of children, may be most essential to their success. Even in ancient time- an era of material and resource deprivation, poor environment still brought up

a batch of extraordinary people. Therefore, conducting family education, focusing more on character and moral advancement, teaching children in accordance with their aptitude and activate their self-consciousness of success are necessary. Blindly following talent-cultivating objectives by buying star-school-district housing may not be acceptable.

6. CONCLUDING REMARKS

In China, due to the scarcity of star school, household registration system and school district demarcation, a feasible way for parents to furnish high-quality education to the next generation is to buy a house in a star school district. Supply-demand imbalance triggers the “soaring housing prices in star school districts” phenomenon. It is especially true for Xiamen, a relatively developed city in China, where people have more disposable income which can be spent in other fields such as housing. The high prices of houses in school district contain the parent's investment of their child's future.

Using Xiamen Island as a case study, this study empirically appraises the value that parents place on school quality by calculating how much more residents pay for houses located in star school districts based on a semi-log linear HPM. And it adds a meaningful empirical study in the Chinese context about quantitative valuation of star school districts to the previous sparse literature, and demonstrates that the prices of housing situated in provincial-level demonstration elementary schools' districts is 9.4% higher than that outside of the area. The magnitude is almost the same as that in Shanghai(8.7%, 9.7%) as reported in (Shi and Wang, (2014)) and (Peng et al., (2014)). Homebuyers' willingness to pay for school quality can be clearly distinguished. Overall, our model is satisfactory, yielding appropriate outcomes, and all signs of variable parameters are consistent with priori expectations. Something related to “soaring housing prices in star school districts” phenomenon has been discussed including school district demarcation, its negative influences and countermeasures.

There are several limitations that deserve further research. Firstly, due to the absence of rich data, some factors like floor area ratio (FAR), property management fee, population density, were not included in our model. Nevertheless, to our delight, our model at this stage has relatively significant and consistent explanatory power. And without exception, de facto signs of the coefficients are in line with expected. Secondly, when representing the picture of location characteristics, we used Euclidean distance (shortest distance, straight-line distance) to measure the accessibility of public services instead of network distance (real-life distance). Thirdly, we used geographical distance instead of travel time when capturing location attributes. Actually, travel time might be more

important than travel distance. Referring to the ease of movement between places, actually, accessibility is a product of mobility and proximity as (Cervero, (2005)) noted. In this regard, our research only considers proximity, totally ignoring mobility, which was a common weakness shared by most of existing literatures. Calculating travel time under different conditions (at least, at peak and non-peak hours) to measure accessibility and putting them into a HPM may yield more reliable and detailed results. We leave these for future work.

REFERENCES

- Acharya, G., Bennett, L.L., 2001. "Valuing open space and land-use patterns in urban watersheds". *The Journal of Real Estate Finance and Economics* 22, 221-237.
- Alonso, W., 1964. "Location and land use. Toward a general theory of land rent". *Location and land use. Toward a general theory of land rent*.
- Armstrong, R.J., Rodriguez, D.A., 2006. "An evaluation of the accessibility benefits of commuter rail in eastern Massachusetts using spatial hedonic price functions". *Transportation* 33, 21-43.
- Ben-Akiva, M.E., Lerman, S.R., 1985. *Discrete choice analysis: theory and application to travel demand*. MIT press.
- Black, S.E., 1999. "Do better schools matter? Parental valuation of elementary education". *Quarterly journal of economics*, 577-599.
- Brasington, D.M., 2003. "The supply of public school quality". *Economics of Education Review* 22, 367-377.
- Xiamen Statistics Bureau, 2014. Xiamen Statistical Yearbook.
- Cassel, E., Mendelsohn, R., 1985. "The choice of functional forms for hedonic price equations: comment". *J Urban Econ* 18, 135-142.
- Cervero, R., 2005. "Accessible cities and regions: a framework for sustainable transport and urbanism in the 21st century". *UC Berkeley Center for Future Urban Transport: A Volvo Center of Excellence*.
- Cervero, R., Duncan, M., 2002. "Transit's value-added effects: light and commuter rail services and commercial land values". *Transportation Research Record: Journal of the Transportation Research Board* 1805, 8-15.
- Chen, L., Tang, X., 2009. "A study on the reason of "star school district" issue and its spillover effect". *China Collective Economy*.
- Clapp, J.M., Nanda, A., Ross, S.L., 2007. "Which school attributes matter? The influence of school district performance and demographic composition on property values". *J Urban Econ* 63, 451-466.
- Des Rosiers, F., Lagana, A., Thériault, M., Beaudoin, M., 1996. "Shopping centres and house values: an empirical investigation". *Journal of Property Valuation and Investment* 14, 41-62.
- Feng, H., Lu, M., 2010. "Selecting School via Buying Houses-an Empirical Evidence and Policy Implication of the Impact of Education on Housing Price". *The Journal of World Economy*.
- Geoghegan, J., 2002. "The value of open spaces in residential land use. *Land Use Policy* 19, 91-98.
- Goodman, A.C., 1978. "Hedonic prices, price indices and housing markets". *J Urban Econ* 5, 471-484.

- Greene, W., 1993. *Econometric Analysis*. Macmillan.
- Halstead, J.M., Bouvier, R.A., Hansen, B.E., 1997. "On the issue of functional form choice in hedonic price functions: further evidence". *Environ Manage* 21, 759-765.
- Hayes, K.J., Taylor, L.L., 1996. "Neighborhood school characteristics: what signals quality to homebuyers?". *Economic Review-Federal Reserve Bank of Dallas*, 2-9.
- Hu, W., Zheng, S., Wang, R., 2014. "The Capitalization of School Quality in Home Value: A Matching Regression Approach with Housing Price-Rent Comparison". *China Economic Quarterly*, 1195-1214.
- Huang, B., 2010. "The impact of education facilities on residential property prices: A case study of the affiliated elementary school of Renmin University of China. *Consume Guide*.
- Kong, F., Yin, H., Nakagoshi, N., 2007. "Using GIS and landscape metrics in the hedonic price modeling of the amenity value of urban green space: A case study in Jinan City, China". *Landscape Urban Plan* 79, 240-252.
- Kong, W., 2003. "A study on present human resources in China". *industrial technology economics*, 30-32.
- Lancaster, K.J., 1966. "A new approach to consumer theory". *The journal of political economy*, 132-157.
- Li, Y., He, L., Xu, W., Wang, H., He, Z., 2013. "Using GIS and Hedonic in the modelling of spatial variation of housing price in Xiamen city". *International Review for Spatial Planning and Sustainable Development* 1, 29-42.
- Luttik, J., 2000. "The value of trees, water and open space as reflected by house prices in the Netherlands". *Landscape Urban Plan* 48, 161-167.
- Malpezzi, S., 2003. "Hedonic pricing models: a selective and applied review". *Section in Housing Economics and Public Policy: Essays in Honor of Duncan MacLennan*.
- Meng, L., 2013. "The Capitalization of Education Resources in Home Value: from the Perspective of "School District"". *Knowledge Economy*, 10-11.
- Nie, F., 2011. "The Influence of Key Primary and Secondary School on Ordinary Housing Price: A Case Study of Banding. Agricultural University of Hebei Province".
- Peng, B., Shi, Y., Shan, Y., Chen, D., 2014. "The Spatial Impacts of Class 3A Comprehensive Hospitals on Peripheral Residential Property Prices in Shanghai". *SCIENTIA GEOGRAPHICA SINICA*.
- Peng, X., Zhao, D., Guo, X., 2009. "The reform of China's Household Registration System: A political Economics View". *Fudan Journal(Social Sciences)*.
- people.cn, 2015. "Soaring housing prices in star school districts in Nanjing". <http://leaders.people.com.cn/n/2015/0514/c217816-27000548.html> (Accessed on 14 May 2015)
- Rosen, S., 1974. "Hedonic prices and implicit markets: product differentiation in pure competition". *The journal of political economy*, 34-55.
- Sedgley, N.H., Williams, N.A., Derrick, F.W., 2008. "The effect of educational test scores on house prices in a model with spatial dependence". *Journal of Housing Economics* 17, 191-200.
- Shi, Y., Wang, Y., 2014. "The Impacting Mechanism of Housing Prices in the School Districts in Shanghai City". *China Land Sciences*, 47-55.
- So, H., Tse, R.Y., Ganesan, S., 1997. "Estimating the influence of transport on house prices: evidence from Hong Kong". *Journal of Property Valuation and Investment* 15, 40-47.
- Tse, R.Y., Love, P.E., 2000. "Measuring residential property values in Hong Kong". *Property Management* 18, 366-374.
- Teaching and Research Section of the Department of Education in Central China Normal University, 1962. *Pedagogy*.
- Wang, W., Yang, H., Sun, Y., Gu, W., 2014a. "A study on the Spatial and Temporal Effects between School District and the Value of Residential Based on Hedonic Model". *Statistics & Information Forum*, 72-78.

- Wang, X., Ge, Y., Zhang, H., 2010. "The Impacting Mechanism of Housing Prices in in the older sections of Nanjing". *CO-Operative Economy & Science*.
- Wang, Z., Mei, L., Wang, L., 2014b. "Research on the Capitalization and Countermeasures to Equilibrium Distribution of Basic Educational Resources: A Case Study of Tianjin". *Journal of Tianjing University of Finance and Economics*, 92-102.
- Wu, X., 2006. "Difficulties and countermeasures: education investment by purchasing housing". *Gansu Social Sciences*, 121-123+202.
- Yang, L., Chang, Y., Ma, Q., Gong, Q., 2015. "The Impact of public services on Housing Prices: A Case Study of Xiamen Island, China". *Urban and Rural Planning*, 32-41.
- Zhang, P., 2011. "Formation of School District House and Its Social Effects: A Example in Tianjin". *Social Work*, 87-90.
- Zhao, Y., 2003. "The reform of Household Registration System in the process of economic transformation". *China Collective Economy*, 16-20+95.



NO.98

Urban Form and Household Photovoltaic Electricity Generation

Jiang Qian Ying^{1*}

1 Gifu University

** Corresponding Author, Email:ying@gifu-u.ac.jp*

Key words: household PV system, house types, car ownership

Abstract: Urban forms have received much attention as to what types of urban forms are greener or more sustainable than others, in the sense that certain types may consume less energy and less land for buildings and transportation as compared to others. A more recent topic relevant with urban forms is concerning with their efficiency of photovoltaic (PV) electricity generation. Indeed, there is an increasing interest in the optimal design of building form, neighborhood patterns, and larger scale urban form in general, to make best utilization of solar energy. It is natural to expect that, as a result, the city may be reshaped in a way adapting to the maximum use of solar energy available. That is, the utilization of solar energy may become a factor that affects urban forms, and subsequently affects the efficiency of energy consumption and land use. It is important to understand these relationships in order to correctly envision the future sustainable urban forms. In this research we make a brief theoretical analysis on these relationships and empirically examine some relevant consequences of household photovoltaic electricity generation on urban forms in Japan. Household photovoltaic electricity generation can be seen as a new type of urban land use. The benefit of household PV electricity generation adds value to the land which is otherwise used for the single purpose of buildings houses. This has an equivalent effect of reducing the opportunity rent (cost) of land of foregoing its alternative use, such as agriculture, which is prevailing outside urban boundary. This idea is expanded within the framework of micro-economic theory of urban land use. Under some standard settings of the theory, it can be derived that household PV electricity generation has the impact of extending the boundary of the city, reducing the residential density, providing the households with larger lot size, and lowering the height of residential buildings. It is well known that low density urban land use is positively correlated with car ownership and the share of trips by car. Therefore, household PV penetration may also increase the use of car by lowering urban residential density.

The actual benefit of PV electricity generation depends on the costs of installing PV system and integrating it into the power network system. In the case of Japan, household PV systems have spread rapidly in recent years (more precisely, since 2009), due to reduction of cost, and to public support through a feed-in tariff (TIF) scheme and direct subsidies for PV installation. Has this trend of household PV system penetration changed the urban form through the various kind of influences described above? We tried to answer this question partially by examining the relationship of PV system installation in new built detached-houses in the 47 prefectures of Japan during 2009-2013, with the change of the share of detached-houses, and the change of car ownership, from an early period (2003-2007) to the period 2009-2013.

The main data sources are:

Number of approvals of subsidy to household PV
(Financial Year 2009-2013, Japan Photovoltaic Expansion Center)

New residential construction starts

(Year 2003-2013, e-Stat: Government Statistics for Japan Statics)

Number of retained motor vehicles

(Year 2003-2013, Automobile Inspection & Registration Association)

The main variables are defined as

$pv = (\text{no. of PV installation in new detached houses built during 2009-2013}) / (\text{no. of detached houses built during 2009-2013})$

$hd = ((dh2 - dh1)) / dh1$

$car = ((car2 - car1)) / car1$

where

$dh1 = (\text{no. of new detached houses built during 2003-2007}) / (\text{no. of total new houses built during 2003-2007})$

$dh2 = (\text{no. of new detached houses built during 2009-2013}) / (\text{no. of total new houses built during 2009-2013})$

$car1 = \text{average car ownership during 2003-2007}$

$car2 = \text{average car ownership during 2009-2013}$

We made a linear regression of dh and car with respect to pv and three control variables: the change rates of residential land price, population density in habitable land, and income per capita (income is measured from 2003-2007 to 2009-2011), denoted as lp , pd and ic , respectively. The main results are as follows (t-values are in brackets)

$dh = 0.234268 pv (2.779431) - 0.17452 lp (-1.8685) - 0.27272 pd (-0.8691) - 0.34459 ic (-2.26842) + 0.014739 (0.67762)$

adjusted $R^2 = 0.268878$

$car = 0.091514 pv (3.88522) - 0.06392 lp (-2.4489) - 0.29015 pd (-3.30868) + 0.050595 ic (1.191817) + 0.00444 (0.730359)$

adjusted $R^2 = 0.628409$

These results suggest that PV penetration may have a non-negligible effect increasing detached house shares and car ownerships, which are important aspects of urban forms. It is implied that in envisioning future optimal urban forms, we need to consider the trade-off between solar energy utilization and the efficiency of energy consumption and land use. It is therefore worth continuing investigation on these relationships.

NO.100

Study on the Promotion of Underground Electrical Distribution Systems

Comparison between Taipei and Tokyo

Hong-Wei Hsiao^{1*} and Mei-Yin Kuan^{2*}

1 Department of urban engineering, the University of Tokyo.

2 Department of eco industry communication and development, National Taiwan University.

** Corresponding Author, Email: sho0503@urban.t.u-tokyo.ac.jp ; mikayla571@gmail.com*

Key words: Smart City, UEDS, ANT, Stakeholder, Taipei, Tokyo

Abstract: Construction of underground distribution systems, including electrical and other lifeline service is an important strategy of Smart city governance for improving the Quality of Life (QoL). It reduces maintenance cost of infrastructure and promotes the urban landscape especially in the city centre area. Most Asian cities have promoted the underground distribution system for years based on the concept of compact city and smart city. This study aims to make clear the policy of underground electrical distribution systems (UEDS) in Taipei, Taiwan and Tokyo, Japan. First, we compare both the institutional and difference about underground electrical distribution systems of two cities. Second, we analyze the policy network of UEDS in each city using an integrated research framework of both stakeholder analysis and actor-network theory (ANT). Finally, we try to discover each stakeholder and actor involving the promotion of UEDS and operate the stakeholder classification according to the ANT analysis. We consider that, even both the central government, NDC of Taiwan, MLIT of Japan and municipal government TCG and TMG play the act as crucial actor in each case, but the electric supplier, TPC of Taiwan plays a more important role than TEPCO of Japan. Besides, Common tunnel system is used in the UEDS in Tokyo and thus makes the cost allocation more fairly and effectively, however, the ratio of UEDS construction is totally lower than in Taipei due to the consideration of business profitability. For future city-wide infrastructure construction, we suggest that discovering the existence and position of each actor is important, what's more, a reasonable cost allocation mechanism will also be essential. User, individual must also be considered as one of the cost payer.

1. INTRODUCTION

Underground Electrical Distribution Systems (called UEDS in this study) has been considered as an important strategy for developing smart city and improving the Quality of Life (QoL). Concretely speaking, operation of UEDS includes decreasing the number of electric poles by putting some overhead cables underground, and a high voltage cable is coordinated with the required parts via ground installation type multi-circuit switch by a pi loop (Isono and Kawasaki, 2001). Use of underground power distribution has grown significantly over the years with the rapid increase in demand for electric energy and the trend for large infra-structures and vast expansion of highly-populated metropolitan areas. Most Asian cities have promoted the underground distribution system for years based on the concept of compact city and smart city.

On the other hand, in recent years the approach to social theory known as Actor-network Theory (ANT) has been adopted within a range of social science fields. Originating in studies of science, technology and society (STS), ANT-or the ‘sociology of translation’ (Callon, 1986; Alcadipani and Hassard, 2010), ANT provides an effective tool to do the interdisciplinary study standing on the STS and sociology base. Considering the promotion of UEDS concerns public administration, policy, planning, engineering etc, we would like to adopt ANT as the main scheme for operating the case study which is composed of multi-aspects research including multi-actor relation, network, power relation and infrastructure system.

2. LITERATURE RE OPPENHEIM, R. (2007)VIEW

2.1 Benefits of Underground Electrical Distribution Systems

Studies (e.g. Akano and Tani, 2011; Nishimura, 2004 ; Nishina, D., Tanaka, D., et al., 2010 ; Nishina, D., Tanaka, D., et al., 2011a, 2011b) emphasize the importance of UEDS on i mproving the urban amenity, landscape, historical townscape and safe pedestrian space. Studies also indicate that UEDS brings some economical effect such like raising the land price and increasing tax revenue (Yonemoto and Murahashi, 2009). As Naskar, A.K., Bhattacharya, N.K., et al., (2013) point out that underground infrastructure development can positively contribute to climate change mitigation by means of providing energy-efficient facilities and enabling high living standards in compact urban areas. Sterling, R., Admiraal, H., et al. (2012) further consider that this kind of system may reduces maintenance cost of infrastructure and promotes the urban landscape especially in the city center area. Promotion of UEDS seems important for

city with heavy population and high-density of development like Taipei and Tokyo when considering a more sustainable and feasible policy toward smart city.

2.2 Actor network theory

Actor-network theory (ANT) is a theory of agency, knowledge and organization. However, what distinguishes ANT from other social constructivist perspectives is that it studies the state of affairs in an action arena as the effect of interactions amongst social actors and non-human entities. After all, we do not consider human beings as mere organisms but as people or social actors because they have material properties and a history of social relations over which they may have some control but on which they equally depend (Law, 1995; Steins, 2001). ANT is associated with the analyses of scientific and technological artefacts by Bruno Latour and Michel Callon in the late 1980s. Whilst Latour has never referred to his own work as “actor–network theory”, the concepts were formalized into a theory by Callon and John Law. In studying science, technology and society (STS), Latour and Callon argue that scientific knowledge is local and constructed by a network of actors. Rather than considering the results or representations produced by science, ANT seeks to identify the processes that produce the results (Comber, A., Fisher, P., et al., 2003). ANT is widely applied to various research fields like resource management, tourism and landscape (Comber, et al., 2003; Allen, 2011), there are also some applications (e.g Jolivet and Heiskanen, 2010) for analyzing the decision making of energy policy and project.

ANT examines the mechanics of power through the construction and maintenance of networks (both human and non-human). Actors become involved in networks from the actors’ interaction with their environment through the process of translation (Rodger, K., Moore, S. A., et al., 2009; Chou and Tsai, 2013). About the actor, Allen (2011) points out that actor includes human or non-human, individual or group, conscious or unconscious, ANT explores the interconnectedness of all things. ANT recognizes that all objects and things exhibit consciousness, and through a consciousness, interact heterogeneously in space; Chou and Tsai (2013) further argue that non-human actors are endogenous variables in the development of inter-organizational relationship.

As previous studies shows that ANT is widely applied to studying the complicated process and relation concerning social and technology issue, besides, non-human actor plays an important role on ANT analysis. In this study, we would consider UEDS as a non-human actor for ANT analysis.

3. MATERIALS AND METHODS

3.1 Analysis framework

There are various stakeholders those who will have benefit or disbenefit by the promotion of UEDS. It is significant to analyze the interaction within each stakeholder during the process of promotion based on ANT. The importance of stakeholder analysis is widely recognized as a necessary means for gaining insight into the complex systemic interactions between natural processes, management policies and local people depending on the resource (Hjortso, C. N., Christensen, S. M., et al., 2005). In such sense, it will be essential to define “stakeholder” at the first stage and quote ANT as the main theory to operate the case analysis of Taipei and Tokyo. As previous studies show the possibility of combination of ANT with other theoretical approach, Martin (2000) utilizes ANT as a framework to delineate and evaluate the social and technical interactions involved in GIS implementation. Luoma-aho and Paloviita (2010) suggest a need to widen stakeholder theory to include non-human influences and indicate that on-human entities may “translate” new, unexpected stakeholders to support their aims by drawing from ANT. In this study, we will first find out each actor and classify each of them as different kind of “stakeholder” according to the ANT-based analysis of Taipei and Tokyo cases.

First, we position each actor according to their basic character and regional level. Another important theoretical element is the ‘obligatory passage point’, a node which acts as an intermediary between networks or network components. A strong obligatory passage point exercises control over resources and is able to claim responsibility for the success of the network (Callon, 1991; Martin, 2000). We then define the ‘obligatory passage point’ of both case and operate the translation analysis adopting both four ‘moments of translation’ and four ‘action intermediaries’. As Callon (1986) propose the four ‘moments of translation’ are: (a) Problematisation; (b) Interessement; (c) Enrolment; (d) Mobilisation; On the other hand, four action intermediaries including (a) Money; (b) Skill/ability; (c) Control; (d) Information; Money as an action intermediary bridges the gap between actors with a vested interest in an actor-network and capacity to do work. Money in the context of direct funding, sales or venture capital becomes translated into orders, actions and recommendations. The circulation of money transformed into action is representative of alignment between those actors providing the financial resources and the output or work accomplished by the actor-network; Skill/ability refers how actor to manage a complex project and produce professional results; Control should be a consideration in tracing an actor-network. The need to address and assess control or power relationships between actors has been recognized within social worlds and arenas theory

(Martin, 2000).

The conventional definition of a stakeholder as the argument of Freeman (1984) is “any group or individual who can affect or is affected by the achievement of the organization’s objectives”. Further, according to the subdivision of ODA (1995), stakeholders might be categorized into key stakeholders, primary stakeholders and secondary stakeholders. However, this study refers to the classification of Martin (2000) and will classify each stakeholder into the following three types according to the translation/intermediary analysis: (a) Input Resources; (b) Accountable stakeholders; (c) Recipients. Then we will display and overview the whole actor network of Taipei and Tokyo case, a comparison between two cases will also be proposed. Figure 1 shows the research framework of this study.

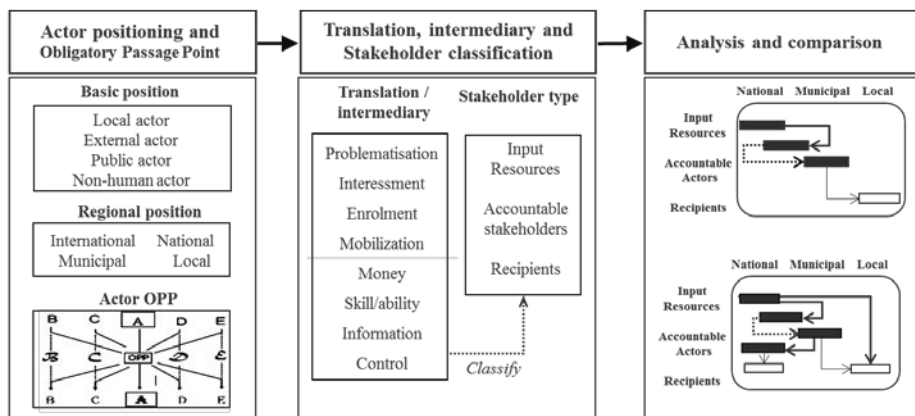

Figure 1. Research framework

3.2 Data collection methods

This study adopts the following approach to collect the qualitative data for ANT-based analysis. We operate times of field research using the following two methods; each field research of this study is summarized as table.1.

3.2.1 Focus groups

As Reed, M. S., Graves, A., et al. (2009) indicates that is a small group brainstorm stakeholders, their interests, influence and other attributes, and categorize them. It is possible to reach group consensus over stakeholder categories; particularly useful for generating data on complex issues that require discussion to develop understanding. We operate focus groups with actors including Taiwan power company (TPC), Taipei city government

(TCG), Tokyo Electric Power Company, Incorporated (TEPCO) and The Foundation of Electronic Companies (FEC), Japan.

3.2.2 Semi-structured interviews

Semi-structured interview is an interview with a cross-section of stakeholders to check/supplement focus group data; This method is also useful for in-depth insights to stakeholder relationships and to triangulate data collected in focus groups (Reed, et al., 2009). We operate semi-structured interviews with actors including TPC, TCG and TEPCO to underground how each of them participate the promotion of UEDS.

Table 1. Summary of each field research

No	Method	Participator/ interviewee	Time
1	Focus groups	Engineering department, FEC (Tokyo, Japan) (Deputy general manager, manager included)	2014/09/30
2	Focus groups	Distribution engineering group, TEPCO (group leader, engineer included)	2014/09/30
3	Focus groups	Taoyuan branch, TPC (director, deputy director and officers included)	2014/10/01
4	Focus groups	Department of power distribution, TPC (director, deputy director and officers included)	2014/10/01
5	Focus groups	New construction office, Public works department, TCG (Deputy commissioner, chief secretary, section chief and officers included)	2014/10/02
6	Semi-structured interviews	Deputy general manager, Engineering dep., FEC	2014/9/30
7	Semi-structured interviews	Section chief, Technical sec., business dep., TPC	2014/10/01
8	Semi-structured interviews	Group leader, distribution engineering group, TEPCO	2014/10/02

4. ANALYSIS AND RESULTS

4.1 Actor network of the promotion of UEDS in Taipei

UEDS promotion policy has a relatively long history in Taipei, tracing back the origin of the policy is an important element for analyzing the actor network. This study summarizes the actor network of promotion of UEDS in Taipei according to the data collected from filed research No.3-5 and 7. The UEDS first started at 1965 in the central Taipei and expended its scale in 1982. Taiwan power company (TPC) started to expend UEDS using the abundant surplus in the selected area following the general planning of

Council for Economic Planning and Development (present National development council, NDC) in 1990. In this period, TPC promoted UEDS actively with their surplus and the subsidy from central government.

Obligatory passage point (OPP) of the promotion of UEDS in Taipei is shown as Figure.2, UEDS was concerned as a necessary project with the process of urban development. In both national level, the NDC, TPC and municipal level, Taipei City government (TCG) expected to construct a high quality of urban landscape and infrastructure system. On the other hand, since other infrastructure system users like water department of TCG, gas companies and telecom companies also use underground pipeline system, how to integrate each system perfectly to avoid trouble was the most important issue for them. For local resident, the existing overhead cable system had become negative factor physically and psychologically, for example, housing nearby the cable or pole might be effected, these facility can also bring problem when facing emergency. To achieve the target of each actor by and conquer each barrier, the OPP might be promotion of UEDS.

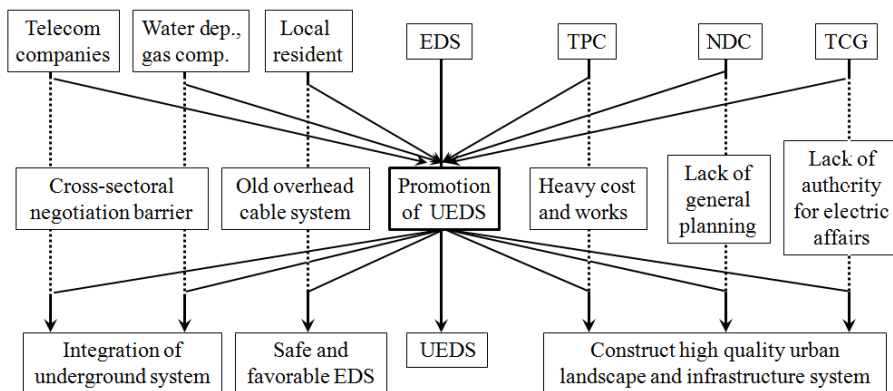

Figure 2. Opp of case study 1, Taipei

The actor network of this stage is shown like Figure.3. The capital provided for promotion of UEDS came from subsidy of NDC and surplus of TPC, basically, TPC led the UEDS project acting as the authority of electric affairs, however, when it came to the part where the road or facility is controlled by TCG, it must be done with the support of TCG. Besides, since all the public construction projects located in Taipei city must be permitted by TCG, the UEDS was actually controlled by both TPC and TCG. The subsidy provider NDC, UEDS executor TPC and TCG is considered directly involved in the UEDS. On the other hand, actor like telecom companies, water department (a subordinate organization of TCG) and gas companies, they don't take part in the UEDS but only share the information about the underground pipeline of each other. They get involved in the promotion of UEDS indirectly. Besides, since TPC was exploring the network of UEDS actively, local residents have nothing to do

but wait for the construction and accept the favor of UEDS.

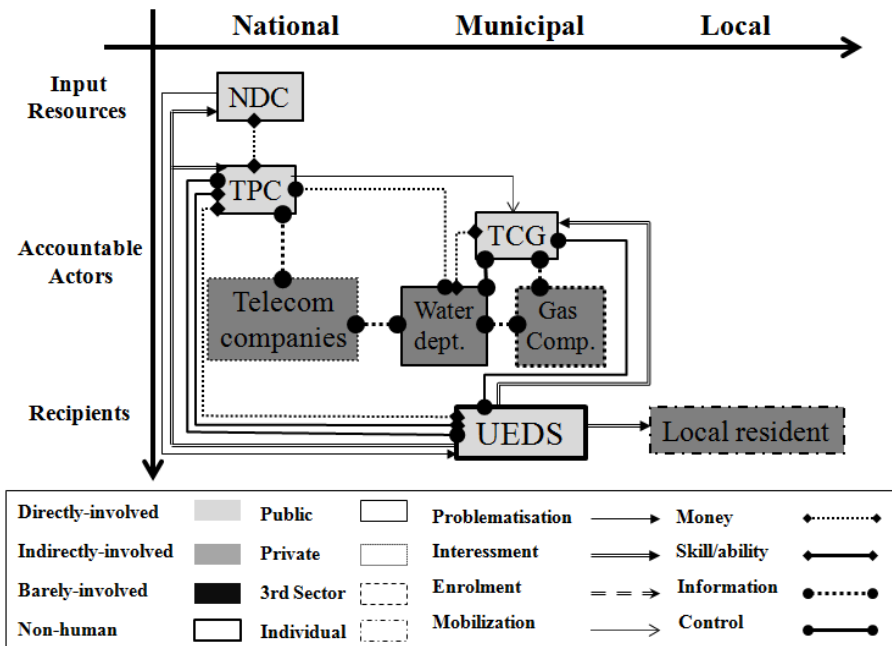

Figure.3: Actor network (translation and intermediary analysis) of promotion of UEDS in Taipei (I)

However, the actor network of promotion of UEDS in Taipei changed with the time. As Section chief, Technical section of TPC told in the field research No.7 that:

The period 1983-2003 was a golden age for promotion of UEDS. It was supported by strong subsidy and surplus following the general planning of NDC. However, since the construction ration of UEDS has reached over 90% after 2000s, on the other hand, the operation of TPC becomes difficult and has almost no surplus to invest in UEDS, TPC now doesn't promote UEDS spontaneously unless being requested by residents. In such case, residents should pay for the cost of UEDS.

The actor network in the present stage (2000~) might be shown as Figure.4, it is almost the same with the first stage, but the local resident become directly involved in the promotion of UEDS since it will be constructed only with the request and cost paying. Besides, as Section chief, Technical section of TPC told us in the field research No.7 that:

Residents tend to petition to councillor (both municipal and national level) for promotion of UEDS. Those areas without UEDS are appealing for priority in the construction of UEDS.

National council and city council emerge as new actors in this stage even though they are barely involved in the promotion of UEDS. The only task for them is pushing TPC and TCG to promote UEDS in each area, even though this might be an effective way due to the cost.

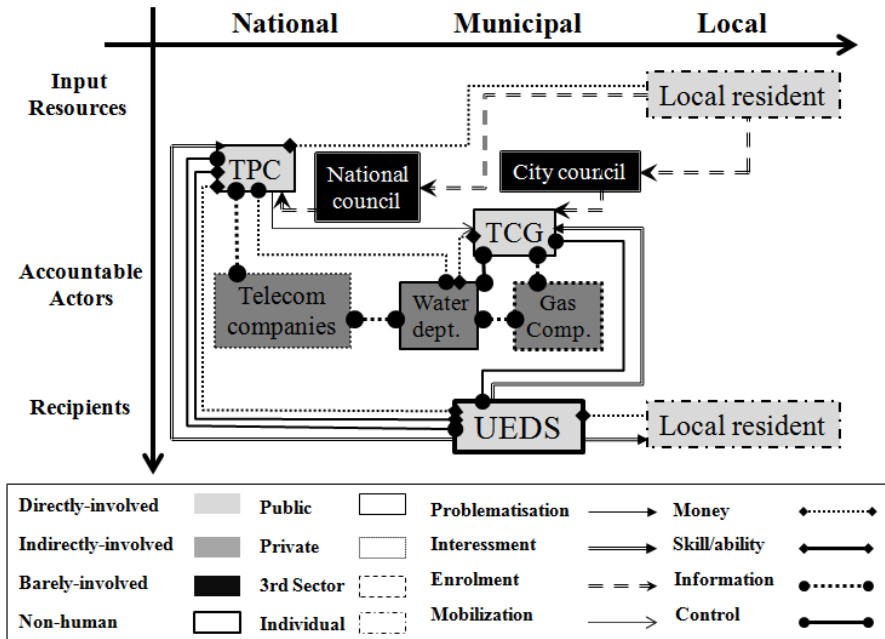

Figure 4.: Translation and intermediary analysis of case study 1, Taipei (II)

We can classify each actor into Input resources, Accountable actors and Recipients according to their attribute as well as their translation and intermediary. TPC acts as both Input resources and Accountable actors in both stages and is actually the most crucial actor. One of the main Input resources, NDC is substituted by Local resident in the Stage two, this is an important proof of the promotion strategy. Meanwhile, Local resident is also one of the most important Recipients other than non-human actor, UEDS.

Table 2. Summary of each actor and their classification

Type of classification	Item	Stage one		Stage two	
		actor	attribute	actor	attribute
Input resources	NDC	National, Public, directly-involved		TPC	National, Public, directly-involved
	TPC	National, Public, directly-involved		Local resident	Local, individual, directly-involved
Accountable actors	TPC	National, Public, directly-involved		Same as Stage one	
	TCG	Municipal, Public, directly-involved		Same as Stage one	
	Telecom Comp.	National, Private, indirectly-involved		Same as Stage one	
	Gas Comp.	Municipal, Private indirectly-involved		Same as Stage one	
	Water Dep.	Municipal, Public, indirectly-involved		Same as Stage one	
	-	-		National council	National, Public, barely-involved
			City council	Municipal, Public, barely-involved	
Recipients	UEDS	Municipal, non-human, directly-involved		Same as Stage one	
	Local resident	Local, individual, indirectly-involved		Local resident	Local, individual, directly-involved

4.2 Actor network of the promotion of UEDS in Tokyo

The promotion of UEDS is totally connected with the Common Tunnel (CT; also called Common Ducts; or Multi-purpose underground utility conduit, MUUC) system in Tokyo. This makes the crucial difference of the actor network from Taipei. This study summarizes the actor network of promotion of UEDS in Taipei according to the data collected from filed research No.1, 2, 6 and 8. The history of UEDS in Tokyo can be dated back to the period from the inauguration of the Tokyo Reconstruction Project to the end of World War II, all done by the project was the efforts to decrease the number of electric poles by putting some overhead cables together on CT. Among many plans, the Tokyo Health Road Plan and the Tokyo Postwar Reconstruction Plan were prominent. The former aimed to remove poles and billboard, building pedestrian-dedicated roads with an affluence of greenery. The latter attempted to remove electric poles from roads which are wider than 36m. Some cables still remained over head were moved to alleyways behind detouring around the roads (Suzuki and Miura, 1999). Though having a long history, there are also some issues about the UEDS policy in Tokyo, as Deputy general manager, Engineering department of FEC told in the field research No.6 that:\

The promotion of UEDS officially started from the late 1980s in Tokyo, however, the resource was invested mainly in the arterial road and to the historical reservation area. The Special act for construction of common Tunnel, the regulation about UEDS was approved in 1995.

The policy for constructing UEDS started later than Taipei, this can also partly explained why the construction ratio of UEDS in Tokyo, is totally lower than in Taipei, we this can be confirmed according to the interview of Group leader, distribution engineering group, TEPCO:

Construction ratio of UEDS in the central Tokyo (Chuo, Chiyoda and Minato ward) is over 80%, however, the ratio in whole Tokyo is about 46%, and the whole area accepting the service from TEPCO is merely 9%.

Figure.5, UEDS was concerned as a necessary project with the process of urban development especially since that Tokyo has been considered as the representative city of Asia. FEC is an association funded by 10 electric companies including TEPCO, the work of FEC is standing with these electric companies to negotiate with governmental department like Ministry of Economy, Trade and Industry (METI) and Ministry of Land, Infrastructure, Transport and Tourism (MLIT). In both national level, the NDC, TPC and municipal level, Taipei City government (TCG) expected to construct a high quality of urban landscape and infrastructure system. For FEC and TEPCO, promoting UEDS might not actually be beneficial for them due to the high construction cost, however, the cost might be relatively low if using CT that the cost will be shared by each user (actor). Integrating each system perfectly into CT system may avoid trouble and help the maintenance work in the future, this is the reason why construction of CT is promoted by the national level, MLIT takes an effort on negotiating with other actors who demands the underground pipeline system including water department of TMG, gas companies and telecom companies. For local resident, the existing overhead cable system had become negative factor physically and psychologically. To achieve the target of each actor by and conquer each barrier the OPP might be promotion of UEDS (CT), even though this might not be the best option for electric company, TEPCO.

The actor network of this stage is shown like Figure.6. The capital provided for promotion of UEDS (CT) came from each actor (user). The construction of CT is controlled by MLIT and TMG respectively according to each project. FEC plays the intermediary role between TEPCO and the central government in order to support the TEPCO financially and institutionally, however FEC does not get involved in the promotion of CT directly. NDC and surplus of TPC, basically, MLIT led the CT project

acting as the authority of electric affairs, however, when it came to the part where the road or facility is controlled by TMG, it must be done with the support of TMG. Besides, since all the public construction projects located in Tokyo must be permitted by TMG, the UEDS (CT) was actually controlled by both MLIT and TMG. They are considered directly involved in the promotion of UEDS (CT). On the other hand, actor like telecom companies, water department (a subordinate organization of TMG) and gas companies, they take part in the promotion of UEDS (CT) by sharing the cost, information about the CT and cooperate with each other to maintain the facility. They also get involved in the promotion of CT directly. Besides, since MLIT and TMG exploring the network of CT actively, local residents have nothing to do but wait for the construction and accept the favour of UEDS (CT). Besides the local resident, each actor (user) involving in the UEDS (CT) like TEPCO, water department, gas and telecom companies also accept the interest (benefit) brought by CT.

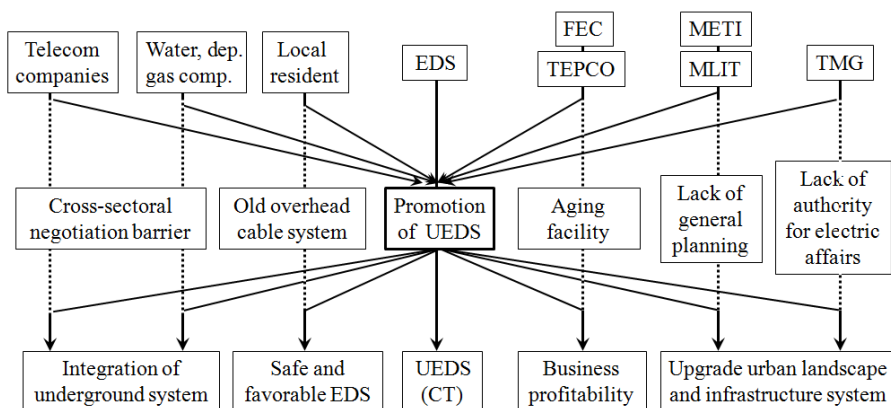

Figure.5: Opp of case study 2, Tokyo

We can classify each actor into Input resources, Accountable actors and Recipients according to their attribute as well as their translation and intermediary. MLIT, TEPCO, TMG, water department, telecom companies and gas companies act as both Input resources and Accountable actors and are actually the most crucial actor. On the other hand, FEC as well as METI are Input resources due to the fact the influence the operation and fiscal support of TEPCO, however they don't actually get involved in the promotion of UEDS (CT). Local resident as well as non-human actor, UEDS (CT) are considered as Recipients in the network.

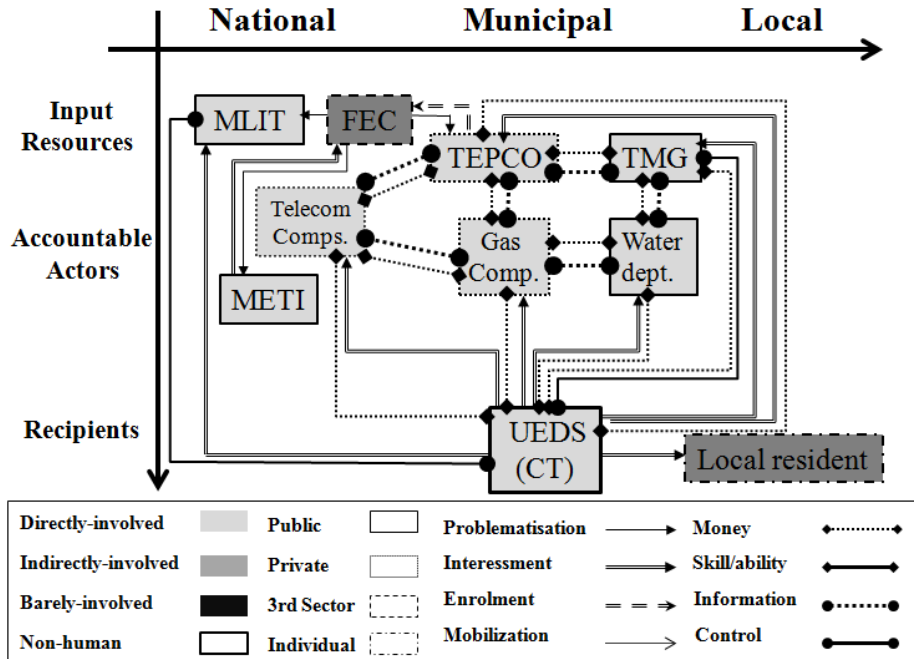

Figure 6. Translation and intermediary analysis of case study 2, Tokyo

Table 2. Summary of each actor and their classification

Type of classification	Item	actor	attribute
Input resources	METI, MLIT	National, Public, directly-involved	
	FEC	National, Public, indirectly-involved	
	TEPCO	Municipal, Private, directly-involved	
	TMG	Municipal, Public, directly-involved	
	Telecom comps.	National, Private, directly-involved	
	Gas comps.	Municipal, Private, directly-involved	
	Water dept.	Municipal, Public, directly-involved	
Accountable actors	MLIT	National, Public, directly-involved	
	TEPCO	Municipal, Private, directly-involved	
	TMG	Municipal, Public, directly-involved	
	Telecom comps.	National, Private, directly-involved	
	Gas comps.	Municipal, Private, directly-involved	
Recipients	Water dept.	Municipal, Public, directly-involved	
	UEDS (CT)	Municipal, non-human, directly-involved	
	Local resident	Local, individual, indirectly-involved	

4.3 Cases comparison

Some important differences about promotion of UEDS between two cities exist. Although the central government, NDC of Taiwan, MLIT of Japan and municipal government TCG and TMG play the act as crucial actor in each case, TPC plays the most crucial actor in the network but TEPCO does not. The difference between two cases is that even both TPC of Taiwan and TEPCO of Japan are the electric supplier, a fundamental difference between them is that the former is governmental company and the latter is private company. The former invest a huge amount of surplus into promotion of UEDS, on the other hand, TEPCO invest to the UEDS (CT) as only a user considering the business profitability.

Besides, since CT is combined with UEDS in the case of Tokyo, it contribute to the multi-actor participation including each underground pipeline user not only TEPCO but telecom companies, gas companies and water department. On the other hand, TPC performs a strong leadership in promoting UEDS as a state-owned enterprise, however, it also gives rise to a low integration of UEDS system between electric cable and other lifeline and thus causes trouble when operating maintenance work or construction project.

Concerning the fiscal resource, the model of Taipei relies on single resource. For example, cost of constructing UEDS relies mainly on TPC's surplus in the first stage and the payment from individual users in the second stage. On the other hand, construction of CT relies on the common fund of CT which is paid by each pipeline user. This might be a more fair and sustainable way for infrastructure construction. Although the CT system has also been promoted in Taipei but it is only a very small part over the whole UEDS system. Each underground pipeline system user prefers constructing their systems respectively rather than using CT system even today.

5. IMPLICATION AND RESULT

This study focuses on the promotion of UEDS in two cities, Taipei and Tokyo. We proposed a new research framework combing stakeholder classification as well as ANT and operate the case study by using this framework. We concluded this study with the following suggestions:

1. The importance of integrated analysis framework of stakeholder and ANT: With the development of concept like public involvement and cross-sectroal cooperation, emergence of multi-stakeholders is an unavoidable outcome. What's more, urban planning and public construction project like UEDS actually involve various actors who

have benefit or inbenefit with it. What's more, ANT provide a fundamental framework to realize the power and interaction between each actor in the complicated real world. It is considered crucial to connect the concept "stakeholder" to clarify the position and task through ANT-based analysis and then classify them into different type of stakeholder according to the overview of the actor network they belong. This study argue the importance of the Stakeholder-ANT framework for the future research of field like urban planning, institutional economics etc.

2. Difference of promotion of UEDS between two cities: Both the central government, NDC of Taiwan, MLIT of Japan and municipal government TCG and TMG play the act as crucial actor in each case. However, the important difference between two cases is that, although both TPC of Taiwan and TEPCO of Japan are the electric supplier, a fundamental difference between them is that the former is governmental company and the latter is private company. TPC is a more powerful actor in both UEDS promotion as well as power supply, while TEPCO acts as a normal private company. The powerful promotion of TPC realized the high ration of UEDS in Taipei with the public fiscal support. Using the CT system actually makes the cost allocation of UEDS promotion more fairly and effectively, however, the ratio of UEDS (CT) is totally lower than in Taipei due to the consideration of business profitability.
3. Future policy suggestion: As two cases shows that the promotion of UEDS involves multi-actors and various stakeholders. Discovering the existence and position of each actor is important, what's more, analyzing their benefit/inbenefit from the aspect of stakeholder will facilitate the network constructing and division of labor. Integrating each user of UEDS will help both the construction, maintenance work and realize the sustainability of UEDS. Besides, a reasonable cost allocation mechanism will also be essential to keep each actor willing to attend to the promotion work. User, individual must also be considered as one of the cost payer for UEDS.

REFERENCES

- Akano, K. and Tani, A. (2011). "Research on Cable-free Townscape in Kanazawa – Proposal for Townscape improvement through Citizen Participation", *日本建築学会北陸支部研究報告集*, 54, 445-448.
- Alcadipani, R. and Hassard, J. (2010), "Actor-Network Theory, organizations and critique: towards a politics of organizing", *Organization*, 17(4) 419-435.
- Allen, C. D. (2011). "On Actor-Network Theory and landscape", *Area*, 43(3), 274-280.
- Callon, M. (1986). "Some elements of a sociology of translation: domestication of the scallops and the fishermen of St Brieuc Bay", First published in J. Law, *Power, action and belief: a new sociology of knowledge?* Routledge, London, 196-223.

- Callon, M. (1991). Techno-economic networks and irreversibility. In *A Sociology of Monsters: Essays on Power, in: Technology and Domination* by J. Law (eds.), Sociological Review Monograph, Routledge, London, 38, 132-161.
- Chou, H. H. and Tsai, C. H. (2013). "Structuring of Interorganizational Relationship Network Governance: A Dynamic Perspective from Actor-Network Theory", *NTURM*, 23(S1), 135-164.
- Comber, A., Fisher, P. and Wadsworth, R. (2003). "Actor-network theory: a suitable framework to understand how land cover mapping projects develop?" *Land Use Policy*, 20(4), 299-309.
- Freeman, R. E. (1984). *Strategic Management: A Stakeholder Approach*, Pitman, Boston.
- Hjortso, C. N., Christensen, S. M. and Tarp, P. (2005). "Rapid stakeholder and conflict assessment for natural resource management using cognitive mapping: The case of Damdoi Forest Enterprise", *Vietnam, Agriculture and Human Values*, 22, 149-167.
- Isono, S. and Kawasaki, K. (2001). "Development of Fault Detector for Underground Distribution Systems", *三菱電線工業時報*, 98, 63-67.
- Jolivet, E. and Heiskanen, E. (2010). "Blowing against the wind-An exploratory application of actor network theory to the analysis of local controversies and participation processes in wind energy", *Energy Policy*, 38, 6746-6754.
- Law, J. (1995). *Organising Modernity*, Blackwell Publishers, Oxford.
- Luoma-aho, V. and Paloviita, A. (2010), "Actor-networking stakeholder theory for today's corporate communications", *Corporate Communications: An International Journal*, 15(1), 49-67.
- Martin, E. W. (2000). "Actor-networks and implementation: examples from conservation GIS in Ecuador", *International Journal of Geographical Information Science*, 14(8), 715-738.
- Naskar, A.K., Bhattacharya, N.K., Saha, S. and Kundu, S.N. (2013). "Thermal analysis of underground power cables using two dimensional finite element method", *Proceeding of, 2013 IEEE 1st International Conference on Condition Assessment Techniques in Electrical Systems*, 94-99.
- Nishimura, Y. (2004). "How to Enhance the Urban Amenity", *The Japanese Journal of Real Estate Sciences (2004-2005)*, 2, 18-22.
- Nishina, D., Tanaka, D. and Oishi, H. (2010). "A study of the Influence on the Psychological Evaluation for Streetscapes by Electric-pole Elimination: Part 1 Outlines of the Experiment and the Results of Psychological Evaluation", *Summaries of technical papers of Annual Meeting Architectural Institute of Japan (D-1)*, 67-68.
- Nishina, D., Tanaka, D., Oishi, H., Ando, S. and Maeno, Y. (2011a). "街路の無電柱化が景観の心理的評価に及ぼす影響：心理的評価と景観構成要素面積比との関連", *MERA Journal*, 14(1), 24.
- Nishina, D., Tanaka, D., Oishi, H., Ando, S. and Maeno, Y. (2011b). "A Study of the Influence on the Psychological Evaluation for Streetscapes by Electric-pole Elimination : Part2 Relation between the Psychological Evaluation and the Physical Indices taken by Field Measurement", *Summaries of technical papers of Annual Meeting Architectural Institute of Japan (D-1)*, 59-60.
- ODA (1995). *Note on Enhancing Stakeholder Participation in Aid Activities*, Overseas Development Administration, London.
- Rodger, K., Moore, S. A. and Newsome, D. (2009). "Wildlife tourism, science and actor network theory", *Annals of Tourism Research*, 36(4), 645-666.
- Steins, N. A. (2001). "New directions in natural resource management the offer of Actor-Network Theory". *IDS Bulletin*, 32, 18-25.
- Sterling, R., Admiraal, H., Bobylev, N., Parker, H., Godard, J. P., Vähäaho, I., Rogers, C. D. F., Shi, X. and Hanamura, T. (2012). "Sustainability issues for underground space in urban areas", *Proceedings of the ICE - Urban Design and Planning*, 165(4), 241-254.